



Catalogue 2024

Air. Anytime. Anywhere.





ABAC is proud to be one of the world's leading providers of innovative compressed air solutions.

Committed to making a difference to our industrial and DIY customers alike, it's our mission to deliver the best compressors, tools and air distribution systems, that perform to the highest standards in the most demanding of conditions.

With every innovation developed by our own research and development team, ABAC aims to make a positive difference through technology, functionality and design.

Working together for a better future is one of our core principles, which is why ABAC is pushing technological boundaries to introduce new products that continually reduce our impact on the environment.

From oil free, screw and silent compressors to professional inflating guns and impact wrenches, ABAC is your perfect compressed air partner, trusted by millions of professionals worldwide for quality, reliability and performance.

INDUSTRIAL S1 PISTON COMPRESSORS



PISTON AIR COMPRESSORS

AIR TOOLS



SCREW COMPRESSORS

AIR TREATMENT

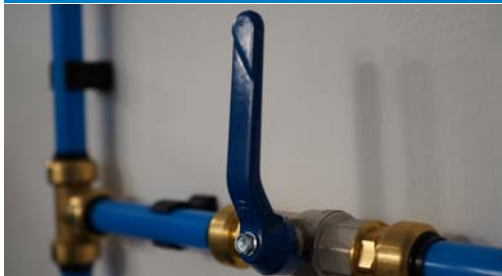

AIR DISTRIBUTION

SERVICE & AFTERMARKET



ABAC Tech - Pro User

Enjoy the constant air with 100% duty cycle, oil free and silent portable range.



Silent



Oil-free



Portable



SPINN D2.2

A compact, high performance compressed air solution.



Easy maintenance



Portable



New integrated block



ABAC Tech - Industrial

Uniquely robust design with 100% duty cycle to match your quality air needs anytime.



Robust



Performance



Options



Professional and DIY Tools

At the forefront of performance, quality, and reliability, the latest tools can handle any challenge.



Lightweight



Highly efficient



Ergonomic



What type of compressor do you need?

Selecting the correct air compressor for your requirements is an important business consideration, ABAC is here to assist you in choosing the right one.

The first stage in the process is to identify the correct size of air compressor, which is determined by your intended application and usage. The compressor size is measured by the rate of air flow and the pressure delivered by the compressor, which needs to be adequate to perform the specific tasks involved.

The best way to find out the total amount of flow needed is to contact ABAC and request data sheets with the required information, or we can help you arrange an audit from an air sales professional.

The second stage of the selection process relates to choosing the correct type of compressor. It is also important to choose the technology which best suits your application.

If your intention is compressed air for intermittent use, then ABAC piston air compressors provide the most appropriate solution. If your application requires a continuous air flow, then a screw compressor would be the best solution.



Checklist

- What is the application?
- How much flow does my facility/workshop use?
- What pressure is needed within the facility?
- Do I need clean/dry air (use of dryer and filters)?
- How many hours per year does my compressor operate?
- Is there fluctuation in flow demand between shifts?
- Are there any plans for future expansion?

PISTON COMPRESSORS vs SCREW COMPRESSORS

- ▶ Most economical and least expensive air compressor technology available
- ▶ Simple and robust air compressors
- ▶ Relatively easy to maintain
- ▶ For intermittent use working at 50-60% duty cycle, meaning they run 30 to 35 minutes, every hour during its duty cycle
- ▶ Used for any operations that require up to a 100% continuous duty cycle
- ▶ Built for long lifetime of reliable operation
- ▶ The ability to integrate a dryer into the package, which is ideal for the applications that require clean and dry air
- ▶ Smaller screw compressors can be tank mounted allowing for additional storage capacity which, coupled with an integrated dryer, allows for plug and play installation



Industrial S1 Piston Compressors

ABAC expanding its offer to the industrial piston range. Now you may have the ABAC expertise on your heavy-duty applications with exceptional reliability.

9



Piston Air Compressors

Our piston portfolio ranges from 0.6 kW to 18.5 kW; from special design, belt driven, and direct driven to larger professional single and 2-stage and semi-industrial designed aluminium and cast iron.

27



Tools & Accessories

Pneumatic tools and accessories for air compressors tailored to professionals needs, with products designed to be powerful, durable and user-friendly.

107



Oil Injected Screw Compressors

Our oil-injected screw compressors are ideal for continuous, workplace and industrial applications. There are two primary versions, oil-injected with fixed speed or variable speed drive options.

141



Air Treatment

Protect your investment with ABAC air treatment and guarantee a constant delivery of clean and dry compressed air. Our range of air treatment solutions includes filtration, dryers, storage and condensate management.

175



Air Distribution

Reliable, efficient, and easy-assembly pipework solutions to cover every customer's demand. A full range of pipes, fittings and accessories.

195



Service & Aftermarket

Solve your service needs quickly, efficiently, and safely with our range of lubricants, service kits, and original spare parts.

215



Industrial S1 Piston Compressors

Air. Anytime. Anywhere.

100% Duty Cycle

Powered by piston, innovated for industrial

The ABAC Tech compressor range of air compressors has been developed to maximise efficiency and minimise downtime in your workplace by providing air on demand, whenever you need it.

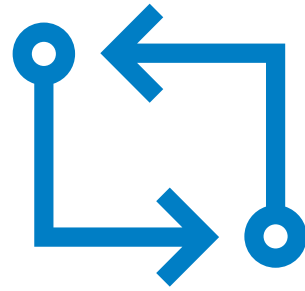

What is a "duty cycle"?

Air compressor duty cycles are easy to understand but often difficult to read because there are no universal characters to represent these values among compressor manufacturers.

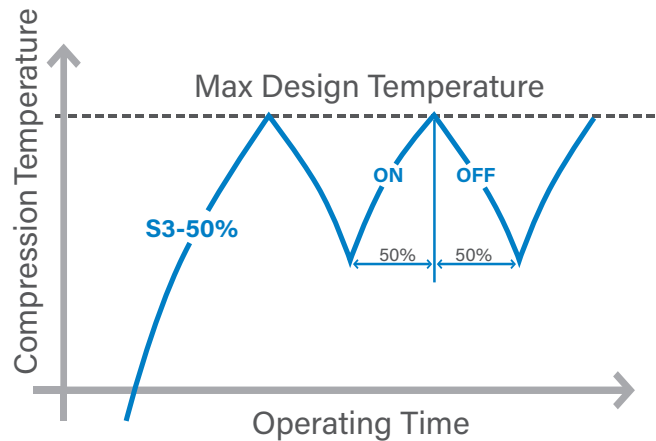

Simply put, an air compressor duty cycle is the amount of time a compressor will deliver pressurised air within a total cycle time. If listed as a percentage, you can simply take the number of seconds or minutes the figure represents and subtract that from the total cycle time.

When listed as a percentage, the duty cycle is equal to the compressor's run time divided by the total cycle time. So, this percentage equates to the amount of time you can keep the compressor on, plus the corresponding cool-down duration.

For example, a compressor with a 50% duty cycle will need 30 minutes off for every 30 minutes on.

In general, the duty cycle formula often used for calculation is expressed as $\text{Compressor time on} / (\text{time on} + \text{time off}) = \text{Duty Cycle percentage}$.

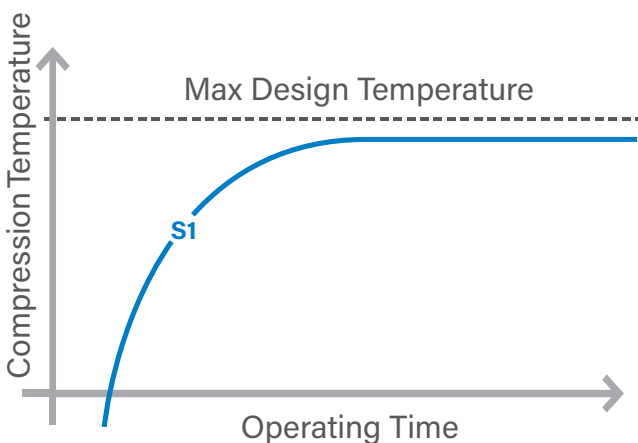

Continuous duty cycles

Continuous duty cycles provide constant power to machinery and tools without any downtime, which improves productivity. Particularly in manufacturing environments, this is a major benefit.

However, in some industries, air compressors with intermittent duty cycles are sufficient, as air is not needed continuously. It all depends on the application and size of the tools being used and our experts can advise on the most suitable products.



How often should an air compressor cycle?

The number of times an air compressor cycles significantly impacts the air compression system's efficiency. Allowing a compressor to cycle more often than the recommended duty cycle can cause it to wear out faster.

Two main methods of increasing cycle time to deliver more air without affecting efficiency or increasing component wear:

- Increasing the tank size
- Widening the pressure band

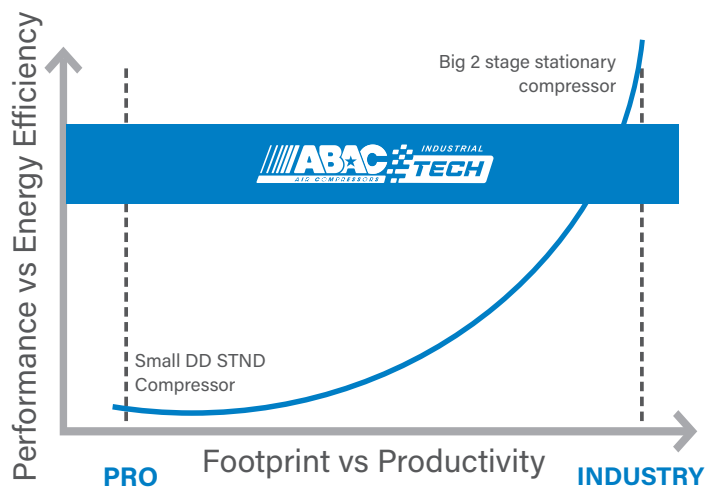

Pro User



Pro User

Abac Tech Industrial range offers uniquely designed portable range to match your quality air needs anytime, anywhere. Enjoy the constant air with 100% duty cycle while having the benefits of oilfree and silent.

Portable - Silent - Oil Free

Abac Tech Pro can be used in wide range of applications thanks to its small footprint. It offers maximum comfort with low vibration, quiet operation and maximum portability. Thanks to oil free, pumps need less maintenance and allows versatile usage.

14

Portable - Silent - Oil Free



ATF-S

Abac Tech Pro can be used in wide range of applications thanks to its small footprint. It offers maximum comfort with low vibration, quiet operation and maximum portability. Thanks to oil free, pumps need less maintenance and allows versatile usage.

Model	Part Number	Configuration	l/min	l/sec	Oil	L	HP	KW	Rpm	Voltz	Bar	dB(A)	LxWxH (mm)	KG	KG Closed	CE Declaration
ATF-S 3 3 10 230/1/50 CE	4116000867	TM	200	3,3	Oil Free	3	3	2,2	1400	230/1/50	10	68	470 x 400 x 600	32	40	Yes
ATF-S 3 24 10 230/1/50 CE	4116000868	TM	200	3,3	Oil Free	24	3	2,2	1400	230/1/50	10	68	550 x 480 x 790	36	45	Yes
ATF-S 3 50 10 230/1/50 CE	4116000880	TM	200	3,3	Oil Free	50	3	2,2	1400	230/1/50	10	68	550 x 480 x 1030	44	55	Yes
ATF-S 4 5+5 10 230/1/50 CE	4116000869	TM	260	4,3	Oil Free	10	4	3	1400	230/1/50	10	72	580 x 790 x 570	50	73	Yes
ATF-S 4 100 10 230/1/50 CE	4116000870	TM	260	4,3	Oil Free	100	4	3	1400	230/1/50	10	72	1030 x 530 x 730	76	100	Yes
ATF-S 4 100 10 400/3/50 CE	4116000871	TM	310	5,2	Oil Free	100	4	3	1400	400/3/50	10	74	1030 x 530 x 730	76	100	Yes
ATF-S 3 3 10 230/1/50 CE UK	4116000872	TM	200	3,3	Oil Free	3	3	2,2	1400	230/1/50	10	68	470 x 400 x 600	32	40	Yes
ATF-S 3 24 10 230/1/50 CE UK	4116000873	TM	200	3,3	Oil Free	24	3	2,2	1400	230/1/50	10	68	550 x 480 x 790	36	45	Yes
ATF-S 3 50 10 230/1/50 CE UK	4116000874	TM	200	3,3	Oil Free	50	3	2,2	1400	230/1/50	10	68	550 x 480 x 1030	44	55	Yes

Industrial

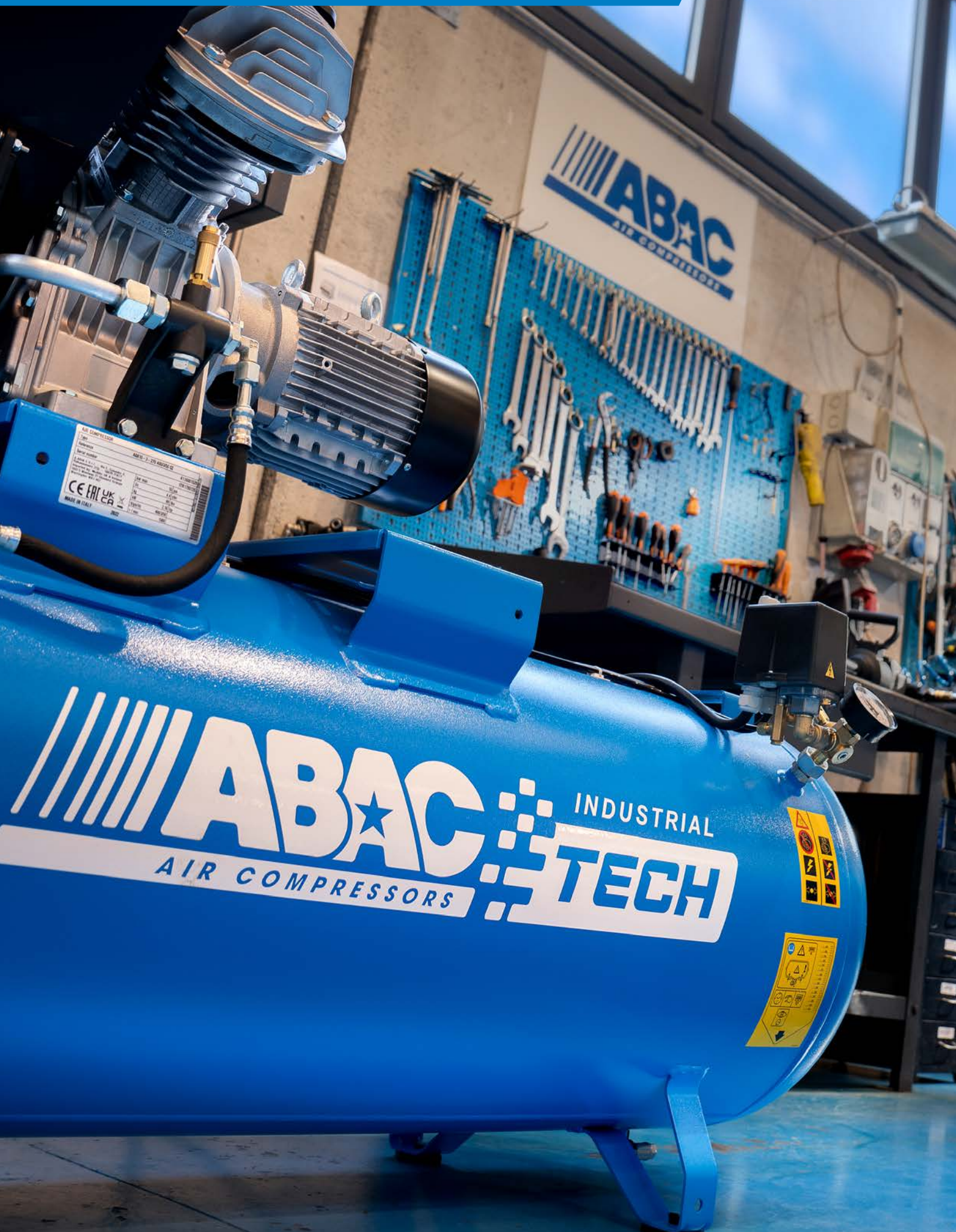

ABAC
AIR COMPRESSORS

AIR COMPRESSOR
Type: ...
Description: ...
Model number: AM 10 - 7 - 220 AIRBLOC G2
CE ENEC UK CA
MADE IN ITALY
2002

ABAC **INDUSTRIAL**
AIR COMPRESSORS **TECH**

Warning labels with safety symbols including a high-pressure warning triangle and a pressure relief valve symbol.

Industrial

Abac Tech Industrial range offers uniquely robust designed to match your quality air needs anytime, anywhere. Enjoy the constant air with 100% duty cycle while having the benefits of oil lubricated up 30Bar and oilfree.

Low Pressure

ABAC Tech Industrial range has been developed to work at 100% Duty Cycle. ATL range is our Oil-lubricated industrial piston compressor range has been designed specifically to support small industrial applications requiring powerful, reliable air.

18

Oil Free

ABAC Tech Industrial range has been developed to work at 100% Duty Cycle. ATF compressors offer pure and clean air, which is required by many applications. Clean air refers to absence of risk of contamination, damage to products which may affect from oil.

20

High Pressure

ABAC Tech Industrial range has been developed to work at 100% Duty Cycle. ATH industrial pistons are designed for pressures of 15, 20 or 30 bar. Perfect for more demanding applications where continuous high-pressure air is essential. Built for the most challenging work environments.

22

ATL-PP



Abac Tech Industrial can be used in wide range of applications thanks to its Power Pack configuration.

Model	Part Number	Configuration	l/min	l/sec	Oil	L	HP	kW	Rpm	Voltz	Bar	dB(A)	dB(A) Closed	LxWxH (mm)	KG	CE Declaration
ATL 2 PP 10 400/3/50 CE	4116001421	PP	204	3,4	Altair Ultra	0	2	1,5	1400	400/3/50	10	78	63	686 x 530 x 547	45	Yes
ATL 3 PP 10 400/3/50 CE	4116001422	PP	264	4,4	Altair Ultra	0	3	2,2	1400	400/3/50	10	79	64	687 x 530 x 547	49	Yes
ATL 5.5 PP 10 400/3/50YD CE	4116001423	PP	504	8,4	Altair Ultra	0	5,5	4	1400	400/3/50	10	79	64	688 x 530 x 547	51	Yes
ATL 7.5 PP 10 400/3/50YD CE	4116001424	PP	702	11,7	Altair Ultra	0	7,5	5,5	1400	400/3/50	10	80	68	860 x 591 x 625	90	Yes
ATL 10 PP 10 400/3/50YD CE	4116001425	PP	942	15,7	Altair Ultra	0	10	7,5	1400	400/3/50	10	81	69	861 x 591 x 625	102	Yes

ATL-BM



Abac Tech Industrial can be used in wide range of applications thanks to its Base Mounted configuration.

Model	Part Number	Configuration	l/min	l/sec	Oil	L	HP	kW	Rpm	Voltz	Bar	dB(A)	dB(A) Closed	LxWxH (mm)	KG	CE Declaration
ATL 2 BM 10 400/3/50 CE	4116001426	BM	204	3,4	Altair Ultra	0	2	1,5	1400	400/3/50	10	78	63	650 x 575 x 631	70	Yes
ATL 3 BM 10 400/3/50 CE	4116001427	BM	264	4,4	Altair Ultra	0	3	2,2	1400	400/3/50	10	79	64	666 x 575 x 631	71	Yes
ATL 5.5 BM 10 400/3/50YD CE	4116001428	BM	504	8,4	Altair Ultra	0	5,5	4	1400	400/3/50	10	79	64	703 x 575 x 631	92	Yes
ATL 7.5 BM 10 400/3/50YD CE	4116001429	BM	702	11,7	Altair Ultra	0	7,5	5,5	1400	400/3/50	10	80	68	1073 x 693 x 721	101	Yes
ATL 10 BM 10 400/3/50YD CE	4116001430	BM	942	15,7	Altair Ultra	0	10	7,5	1400	400/3/50	10	81	69	1073 x 693 x 721	120	Yes

ATL-TM

Abac Tech Industrial can be used in wide range of applications thanks to its Tank Mounted configuration.



Model	Part Number	Configuration	l/min	l/sec	Oil	L	HP	kW	Rpm	Voltz	Bar	dB(A)	dB(A) Closed	LxWxH (mm)	KG	CE Declaration
ATL 2 90 10 400/3/50 CE	4116001431	TM	204	3,4	Altair Ultra	90	2	1,5	1400	400/3/50	10	78	63	996 x 504 x 979	85	Yes
ATL 2 90 10 230/1/50 CE	4116001432	TM	204	3,4	Altair Ultra	90	2	1,5	1400	230/1/50	10	78	63	997 x 504 x 979	85	Yes
ATL 3 90 10 400/3/50 CE	4116001433	TM	264	4,4	Altair Ultra	90	3	2,2	1400	400/3/50	10	79	64	998 x 504 x 979	89	Yes
ATL 3 90 10 230/1/50 CE	4116001434	TM	264	4,4	Altair Ultra	90	3	2,2	1400	230/1/50	10	79	64	999 x 504 x 979	118	Yes
ATL 3 270 10 400/3/50 CE	4116001435	TM	264	4,4	Altair Ultra	270	3	2,2	1400	400/3/50	10	79	64	1540 x 504 x 1200	148	Yes
ATL 5.5 270 10 400/3/50 CE	4116001436	TM	504	8,4	Altair Ultra	270	5,5	4	1400	400/3/50	10	79	64	1540 x 592 x 1200	150	Yes
ATL 7.5 270 10 400/3/50YD CE	4116001437	TM	702	11,7	Altair Ultra	270	7,5	5,5	1400	400/3/50	10	80	68	1540 x 606 x 1200	187	Yes
ATL 10 500 10 400/3/50YD CE	4116001438	TM	942	15,7	Altair Ultra	500	10	7,5	1400	400/3/50	10	81	69	1940 x 606 x 1340	204	Yes

ATL-FF

Abac Tech Industrial can be used in wide range of applications thanks to its Full Featured configuration.



Model	Part Number	Configuration	l/min	l/sec	Oil	L	HP	kW	Rpm	Voltz	Bar	dB(A)	dB(A) Closed	LxWxH (mm)	KG	Dryer	CE Declaration
ATL 2 270D 10 400/3/50 CE	4116001439	TMD	204	3,4	Altair Ultra	270	2	1,5	1400	400/3/50	10	78	63	1644 x 748 x 1176	141	Yes	Yes
ATL 3 270D 10 400/3/50 CE	4116001440	TMD	264	4,4	Altair Ultra	270	3	2,2	1400	400/3/50	10	79	64	1644 x 748 x 1176	175	Yes	Yes
ATL 5.5 270D 10 400/3/50YD CE	4116001441	TMD	504	8,4	Altair Ultra	270	5,5	4	1400	400/3/50	10	79	64	1650 x 748 x 1176	177	Yes	Yes
ATL 7.5 500D 10 400/3/50YD CE	4116001442	TMD	702	11,7	Altair Ultra	500	7,5	5,5	1400	400/3/50	10	80	68	1990 x 748 x 1390	265	Yes	Yes
ATL 10 500D 10 400/3/50YD CE	4116001443	TMD	942	15,7	Altair Ultra	500	10	7,5	1400	400/3/50	10	81	69	1991 x 748 x 1390	282	Yes	Yes

ATF-PP



Abac Tech Industrial can be used in wide range of applications thanks to its Power Pack configuration.

Model	Part Number	Configuration	l/min	l/sec	Oil	L	HP	kW	Rpm	Voltz	Bar	dB(A)	dB(A) Closed	LxWxH (mm)	KG	CE Declaration
ATF 2 PP 10 400/3/50 CE	4116001444	PP	186	3,1	Oil Free	0	2	1,5	1400	400/3/50	10	82	69	686 x 530 x 547	45	Yes
ATF 3 PP 10 400/3/50 CE	4116001445	PP	240	4,0	Oil Free	0	3	2,2	1400	400/3/50	10	83	70	687 x 530 x 547	49	Yes
ATF 5.5 PP 10 400/3/50YD CE	4116001446	PP	492	8,2	Oil Free	0	5,5	4	1400	400/3/50	10	83	70	688 x 530 x 547	90	Yes
ATF 7.5 PP 10 400/3/50YD CE	4116001447	PP	660	11,0	Oil Free	0	7,5	5,5	1400	400/3/50	10	84	74	860 x 591 x 625	90	Yes
ATF 10 PP 10 400/3/50YD CE	4116001448	PP	930	15,5	Oil Free	0	10	7,5	1400	400/3/50	10	86	77	861 x 591 x 625	105	Yes

ATF-BM



Abac Tech Industrial can be used in wide range of applications thanks to its Base Mounted configuration.

Model	Part Number	Configuration	l/min	l/sec	Oil	L	HP	kW	Rpm	Voltz	Bar	dB(A)	dB(A) Closed	LxWxH (mm)	KG	CE Declaration
ATF 2 BM 10 400/3/50 CE	4116001449	BM	186	3,1	Oil Free	0	2	1,5	1400	400/3/50	10	82	69	1036 x 680 x 721	101	Yes
ATF 3 BM 10 400/3/50 CE	4116001450	BM	240	4,0	Oil Free	0	3	2,2	1400	400/3/50	10	83	70	666 x 575 x 631	101	Yes
ATF 5.5 BM 10 400/3/50YD CE	4116001451	BM	492	8,2	Oil Free	0	5,5	4	1400	400/3/50	10	83	70	703 x 575 x 631	95	Yes
ATF 7.5 BM 10 400/3/50YD CE	4116001452	BM	660	11,0	Oil Free	0	7,5	5,5	1400	400/3/50	10	84	74	1073 x 693 x 721	101	Yes
ATF 10 BM 10 400/3/50YD CE	4116001453	BM	930	15,5	Oil Free	0	10	7,5	1400	400/3/50	10	86	77	1074 x 693 x 721	190	Yes

ATF-TM

Abac Tech Industrial can be used in wide range of applications thanks to its Tank Mounted configuration.



Model	Part Number	Configuration	l/min	l/sec	Oil	L	HP	KW	Rpm	Voltz	Bar	dB(A)	dB(A) Closed	LxWxH (mm)	KG	CE Declaration
ATF 2 90 10 400/3/50 CE	4116001454	TM	186	3,1	Oil Free	90	2	1,5	1400	400/3/50	10	82	69	996 x 504 x 979	125	Yes
ATF 2 90 10 230/1/50 CE	4116001455	TM	186	3,1	Oil Free	90	2	1,5	1400	230/1/50	10	82	69	997 x 504 x 979	85	Yes
ATF 3 90 10 400/3/50 CE	4116001456	TM	240	4,0	Oil Free	90	3	2,2	1400	400/3/50	10	83	70	998 x 504 x 979	85	Yes
ATF 3 90 10 230/1/50 CE	4116001457	TM	240	4,0	Oil Free	90	3	2,2	1400	230/1/50	10	83	70	999 x 504 x 979	89	Yes
ATF 5.5 270 10 400/3/50 CE	4116001458	TM	492	8,2	Oil Free	270	5,5	4	1400	400/3/50	10	83	70	1540 x 592 x 1200	150	Yes
ATF 7.5 500 10 400/3/50YD CE	4116001459	TM	660	11,0	Oil Free	500	7,5	5,5	1400	400/3/50	10	84	74	1940 x 606 x 1340	260	Yes
ATF 10 500 10 400/3/50YD CE	4116001460	TM	930	15,5	Oil Free	500	10	7,5	1400	400/3/50	10	86	77	1941 x 606 x 1340	275	Yes

ATF-FF

Abac Tech Industrial can be used in wide range of applications thanks to its Full Featured configuration.



Model	Part Number	Configuration	l/min	l/sec	Oil	L	HP	KW	Rpm	Voltz	Bar	dB(A)	dB(A) Closed	LxWxH (mm)	KG	Dryer	CE Declaration
ATF 2 270D 10 400/3/50 CE	4116001461	TMD	186	3,1	Oil Free	270	2	1,5	1400	400/3/50	10	82	69	1644 x 748 x 1176	171	Yes	Yes
ATF 3 270D 10 400/3/50 CE	4116001462	TMD	240	4,0	Oil Free	270	3	2,2	1400	400/3/50	10	83	70	1644 x 748 x 1176	175	Yes	Yes
ATF 5.5 270D 10 400/3/50YD CE	4116001463	TMD	492	8,2	Oil Free	270	5,5	4	1400	400/3/50	10	83	70	1650 x 748 x 1176	122	Yes	Yes
ATF 7.5 500D 10 400/3/50YD CE	4116001464	TMD	660	11,0	Oil Free	500	7,5	5,5	1400	400/3/50	10	84	74	1990 x 748 x 1390	265	Yes	Yes
ATF 10 500D 10 400/3/50YD CE	4116001465	TMD	930	15,5	Oil Free	500	10	7,5	1400	400/3/50	10	86	77	1990 x 748 x 1390	350	Yes	Yes

ATH-PP



Abac Tech Industrial can be used in wide range of applications thanks to its Power Pack configuration.

Model	Part Number	Configuration	l/min	l/sec	Oil	L	HP	kW	Rpm	Voltz	Bar	dB(A)	dB(A) Closed	LxWxH (mm)	KG	CE Declaration
ATH 2 PP 15 400/3/50 CE	4116001466	PP	186	3,1	Altair Ultra	0	2	1,5	1400	400/3/50	15	78	63	686 x 533 x 507	45	Yes
ATH 3 PP 15 400/3/50 CE	4116001467	PP	240	4,0	Altair Ultra	0	3	2,2	1400	400/3/50	15	79	64	686 x 533 x 507	49	Yes
ATH 5.5 PP 15 400/3/50YD CE	4116001468	PP	402	6,7	Altair Ultra	0	5,5	4	1400	400/3/50	15	79	64	686 x 533 x 507	51	Yes
ATH 7.5 PP 15 400/3/50YD CE	4116001469	PP	552	9,2	Altair Ultra	0	7,5	5,5	1400	400/3/50	15	80	68	860 x 606 x 600	90	Yes
ATH 10 PP 15 400/3/50YD CE	4116001470	PP	702	11,7	Altair Ultra	0	10	7,5	1400	400/3/50	15	81	68	932 x 606 x 600	102	Yes

ATH-BM



Abac Tech Industrial can be used in wide range of applications thanks to its Base Mounted configuration.

Model	Part Number	Configuration	l/min	l/sec	Oil	L	HP	kW	Rpm	Voltz	Bar	dB(A)	dB(A) Closed	LxWxH (mm)	KG	CE Declaration
ATH 2 BM 15 400/3/50 CE	4116001471	BM	186	3,1	Altair Ultra	0	2	1,5	1400	400/3/50	15	78	63	650 x 575 x 641	101	Yes
ATH 3 BM 15 400/3/50 CE	4116001472	BM	240	4,0	Altair Ultra	0	3	2,2	1400	400/3/50	15	79	64	666 x 575 x 641	92	Yes
ATH 5.5 BM 15 400/3/50YD CE	4116001473	BM	402	6,7	Altair Ultra	0	5,5	4	1400	400/3/50	15	79	64	1260 x 890 x 880	90	Yes
ATH 7.5 BM 15 400/3/50YD CE	4116001474	BM	552	9,2	Altair Ultra	0	7,5	5,5	1400	400/3/50	15	80	68	1073 x 693 x 721	107	Yes
ATH 10 BM 15 400/3/50YD CE	4116001475	BM	702	11,7	Altair Ultra	0	10	7,5	1400	400/3/50	15	81	68	1073 x 693 x 721	171	Yes

ATH-TM



Abac Tech Industrial can be used in wide range of applications thanks to its Tank Mounted configuration.

Model	Part Number	Configuration	l/min	l/sec	Oil	L	HP	kW	Rpm	Voltz	Bar	dB(A)	dB(A) Closed	LxWxH (mm)	KG	CE Declaration
ATH 2 90 15 400/3/50 CE	4116001476	TM	186	3,1	Altair Ultra	90	2	1,5	1400	400/3/50	15	78	63	1000 x 533 x 980	100	Yes
ATH 3 90 15 400/3/50 CE	4116001477	TM	240	4,0	Altair Ultra	90	3	2,2	1400	400/3/50	15	79	64	1000 x 533 x 980	85	Yes
ATH 5.5 270 15 400/3/50 CE	4116001478	TM	402	6,7	Altair Ultra	270	5,5	4	1400	400/3/50	15	79	64	1915 x 533 x 1082	170	Yes
ATH 7.5 270 15 400/3/50YD CE	4116001479	TM	552	9,2	Altair Ultra	270	7,5	5,5	1400	400/3/50	15	80	68	1915 x 606 x 1162	211	Yes
ATH 10 270 15 400/3/50YD CE	4116001480	TM	702	11,7	Altair Ultra	270	10	7,5	1400	400/3/50	15	81	68	1915 x 606 x 1162	251	Yes

ATH-PP



Abac Tech Industrial can be used in wide range of applications thanks to its Power Pack configuration.

Model	Part Number	Configuration	l/min	l/sec	Oil	L	HP	kW	Rpm	Voltz	Bar	dB(A)	dB(A) Closed	LxWxH (mm)	KG	CE Declaration
ATH 2 PP 20 400/3/50 CE	4116001481	PP	126	2,1	Altair Ultra	0	2	1,5	1400	400/3/50	20	78	63	686 x 533 x 507	45	Yes
ATH 3 PP 20 400/3/50 CE	4116001482	PP	174	2,9	Altair Ultra	0	3	2,2	1400	400/3/50	20	79	64	686 x 533 x 507	49	Yes
ATH 5.5 PP 20 400/3/50YD CE	4116001483	PP	300	5,0	Altair Ultra	0	5,5	4	1400	400/3/50	20	79	64	686 x 533 x 507	51	Yes
ATH 7.5 PP 20 400/3/50YD CE	4116001484	PP	402	6,7	Altair Ultra	0	7,5	5,5	1400	400/3/50	20	80	68	860 x 606 x 600	90	Yes
ATH 10 PP 20 400/3/50YD CE	4116001485	PP	546	9,1	Altair Ultra	0	10	7,5	1400	400/3/50	20	81	68	932 x 606 x 600	102	Yes
ATH 15 PP 20 400/3/50YD CE	4116001486	PP	906	15,1	Altair Ultra	0	15	11	1400	400/3/50	20	86	75	1053 x 682 x 675	194	Yes
ATH 20 PP 20 400/3/50YD CE	4116001487	PP	1080	18,0	Altair Ultra	0	20	15	1400	400/3/50	20	86	78	1103 x 713 x 675	250	Yes

ATH-BM



Abac Tech Industrial can be used in wide range of applications thanks to its Base Mounted configuration.

Model	Part Number	Configuration	l/min	l/sec	Oil	L	HP	kW	Rpm	Voltz	Bar	dB(A)	dB(A) Closed	LxWxH (mm)	KG	CE Declaration
ATH 2 BM 20 400/3/50 CE	4116001488	BM	126	2,1	Altair Ultra	0	2	1,5	1400	400/3/50	20	78	63	650 x 575 x 641	100	Yes
ATH 3 BM 20 400/3/50 CE	4116001489	BM	174	2,9	Altair Ultra	0	3	2,2	1400	400/3/50	20	79	64	666 x 575 x 641	92	Yes
ATH 5.5 BM 20 400/3/50YD CE	4116001490	BM	300	5,0	Altair Ultra	0	5,5	4	1400	400/3/50	20	79	64	703 x 575 x 641	92	Yes
ATH 7.5 BM 20 400/3/50YD CE	4116001491	BM	402	6,7	Altair Ultra	0	7,5	5,5	1400	400/3/50	20	80	68	859 x 625 x 721	92	Yes
ATH 10 BM 20 400/3/50YD CE	4116001492	BM	546	9,1	Altair Ultra	0	10	7,5	1400	400/3/50	20	81	68	1073 x 693 x 721	171	Yes
ATH 15 BM 20 400/3/50YD CE	4116001493	BM	906	15,1	Altair Ultra	0	15	11	1400	400/3/50	20	86	75	1067 x 820 x 840	263	Yes
ATH 20 BM 20 400/3/50YD CE	4116001494	BM	1080	18,0	Altair Ultra	0	20	15	1400	400/3/50	20	86	78	1118 x 820 x 840	171	Yes

ATH-TM



Abac Tech Industrial can be used in wide range of applications thanks to its Tank Mounted configuration.

Model	Part Number	Configuration	l/min	l/sec	Oil	L	HP	kW	Rpm	Voltz	Bar	dB(A)	dB(A) Closed	LxWxH (mm)	KG	CE Declaration
ATH 2 90 20 400/3/50 CE	4116001495	TM	126	2,1	Altair Ultra	90	2	1,5	1400	400/3/50	20	78	63	1000 x 670 x 980	95	Yes
ATH 3 90 20 400/3/50 CE	4116001496	TM	174	2,9	Altair Ultra	90	3	2,2	1400	400/3/50	20	79	64	1000 x 670 x 980	127	Yes
ATH 5.5 270 20 400/3/50 CE	4116001497	TM	300	5,0	Altair Ultra	270	5,5	4	1400	400/3/50	20	79	64	1915 x 533 x 1082	150	Yes
ATH 7.5 270 20 400/3/50YD CE	4116001498	TM	402	6,7	Altair Ultra	270	7,5	5,5	1400	400/3/50	20	80	68	1915 x 606 x 1162	170	Yes
ATH 10 270 20 400/3/50YD CE	4116001499	TM	546	9,1	Altair Ultra	270	10	7,5	1400	400/3/50	20	81	68	1915 x 606 x 1162	170	Yes
ATH 15 270 20 400/3/50YD CE	4116001500	TM	906	15,1	Altair Ultra	270	15	11	1400	400/3/50	20	86	75	1901 x 682 x 1235	308	Yes
ATH 20 270 20 400/3/50YD CE	4116001501	TM	1080	18,0	Altair Ultra	270	20	15	1400	400/3/50	20	86	78	1901 x 713 x 1235	302	Yes

ATH-PP



Abac Tech Industrial can be used in wide range of applications thanks to its Power Pack configuration.

Model	Part Number	Configuration	l/min	l/sec	Oil	L	HP	kW	Rpm	Voltz	Bar	dB(A)	dB(A) Closed	LxWxH (mm)	KG	CE Declaration
ATH 3 PP 30 400/3/50 CE	4116001502	PP	150	2,5	Altair Ultra	0	3	2,2	1400	400/3/50	30	79	64	686 x 533 x 507	49	Yes
ATH 5.5 PP 30 400/3/50YD CE	4116001503	PP	264	4,4	Altair Ultra	0	5,5	4	1400	400/3/50	30	79	64	686 x 533 x 507	51	Yes
ATH 7.5 PP 30 400/3/50YD CE	4116001504	PP	384	6,4	Altair Ultra	0	7,5	5,5	1400	400/3/50	30	80	68	860 x 606 x 600	90	Yes
ATH 10 PP 30 400/3/50YD CE	4116001505	PP	510	8,5	Altair Ultra	0	10	7,5	1400	400/3/50	30	81	68	932 x 606 x 600	102	Yes
ATH 15 PP 30 400/3/50YD CE	4116001506	PP	558	9,3	Altair Ultra	0	15	11	1400	400/3/50	30	85	76	1053 x 720 x 675	165	Yes
ATH 20 PP 30 400/3/50YD CE	4116001507	PP	1020	17,0	Altair Ultra	0	20	15	1400	400/3/50	30	86	80	1103 x 720 x 675	194	Yes

ATH-BM



Abac Tech Industrial can be used in wide range of applications thanks to its Base Mounted configuration.

Model	Part Number	Configuration	l/min	l/sec	Oil	L	HP	kW	Rpm	Voltz	Bar	dB(A)	dB(A) Closed	LxWxH (mm)	KG	CE Declaration
ATH 3 BM 30 400/3/50 CE	4116001508	BM	150	2,5	Altair Ultra	0	3	2,2	1400	400/3/50	30	79	64	1000 x 8000 x 6000	92	Yes
ATH 5.5 BM 30 400/3/50YD CE	4116001509	BM	264	4,4	Altair Ultra	0	5,5	4	1400	400/3/50	30	79	64	703 x 575 x 641	82	Yes
ATH 7.5 BM 30 400/3/50YD CE	4116001510	BM	384	6,4	Altair Ultra	0	7,5	5,5	1400	400/3/50	30	80	68	1073 x 693 x 721	90	Yes
ATH 10 BM 30 400/3/50YD CE	4116001511	BM	510	8,5	Altair Ultra	0	10	7,5	1400	400/3/50	30	81	68	948 x 775 x 787	126	Yes
ATH 15 BM 30 400/3/50YD CE	4116001512	BM	558	9,3	Altair Ultra	0	15	11	1400	400/3/50	30	85	76	1660 x 990 x 1050	160	Yes
ATH 20 BM 30 400/3/50YD CE	4116001513	BM	1020	17,0	Altair Ultra	0	20	15	1400	400/3/50	30	86	80	1260 x 890 x 1020	250	Yes



Piston air compressors

Air. Anytime. Anywhere.

Choose the right compressor for the job

EXAMPLE FOR THE APPLICATIONS

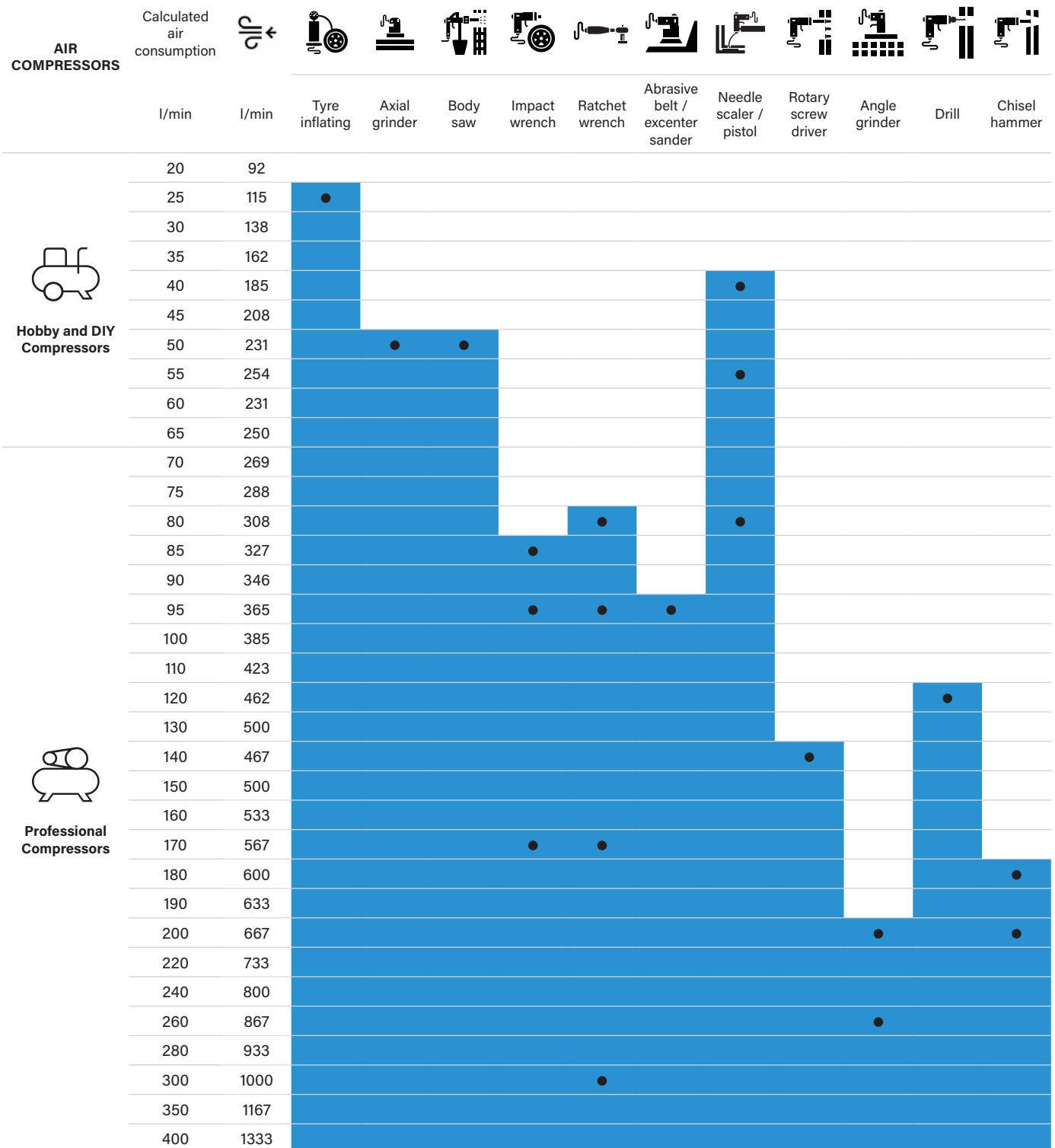

Well-suited Very well-suited

Understanding sound power and equipment labelling

Mechanical power and vibration radiating from a specific source results in a pressure fluctuation in the air, which causes sound.

When using an air compressor, what we hear is the relationship between the power of the compressor itself and the space in which it is operating.

This noise level expressed on the label as (LWA) is measured in decibels dB(A), which is a weighted scale for judging loudness that corresponds to the hearing threshold of the human ear. For example, a standard 3HP air compressor has a noise level of 93 dB(A). The sound pressure level LPA dB(A) is also expressed in decibels, so the same 3HP air compressor generates a sound pressure level of 73 dB(A).

The precise LPA value is dependent on the distance between the source of power and the acoustic environment of propagation.

The standard distance used in this calculation by the industry is 4 metres between the user and machine. To sum it up: the sound power level of technical sound sources is usually around 10 to 15 dB higher than the sound pressure level at a distance of 1m, and around 20 dB higher for distance of 4m.



Compressor Label Sound Values: In accordance with CEE regulations, it is mandatory for the sound power level (LWA) to be clearly displayed on all air compressors.



dB(A)

65

Compressor Sound Values in this catalogue are shown in dB(A).

Comparison for a sound level dB(A)



Threshold of hearing
0 dB(A)



Bird call
40 dB(A)



Passing car
75 dB(A)



Blender
88 dB(A)



Emergency siren
140 dB(A)

Piston Compressors Direct Drive

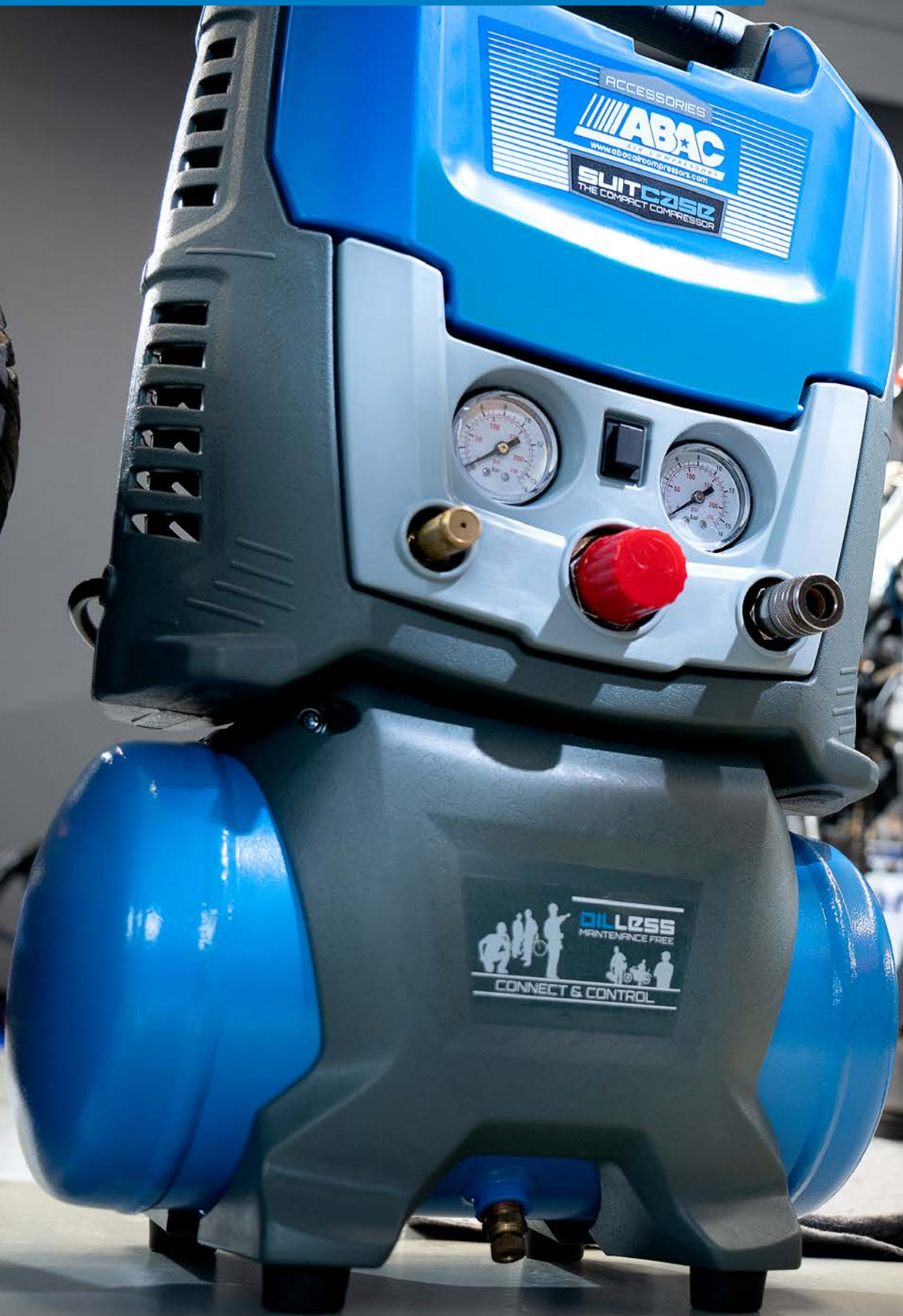

Piston Compressors Direct Drive

Best price/performance option for wide range of applications with efficient energy use.

Special Design

One-of-a-kind designed, versatile & efficient use air compressors.

32

Base Line

Tailored for hobbyists and DIY use these compressors are perfect for occasional or intermittent use and ideal for applications such as inflating, blowing, cleaning, airbrushing stapling, simple painting and nailing. Designed for easier use and versatility, the products meet the most demanding needs.

33

Line

Meet the best-seller direct driven LINE. Products that answer the most demanding needs.

34

Pro Line

User-friendly, efficient mobile compressors, perfectly designed for your daily use.

36

Semi Silent

More productivity - less pollution, less maintenance in a silent way. Compressed air for every challenge.

40

Super Silent

Join the silent revolution. Uniquely designed silent - oilfree compressors for easy use with low maintenance.

42

Clean Air

We developed our oil-free compressors and filters to give you a reliable source of clean, compressed air. The ABAC CleanAir compressors are available with desiccant dryers and also in silenced models.

45



SUITCASE 0 LT - Special Design

Ease of use and compactness are the most notable attributes behind ABAC SUITCASE air compressor. It weighs only 10 kg and can be effortlessly transported with an anti-slip handle everywhere you want.

Model	Part Number	Configuration	l/min	Engine	Oil	Pump	L	HP	kW	Rpm	Voltz	Bar	Start type	dB(A)	LxWxH (mm)	KG	Dryer
SUITCASE - 0	2236115858	BM	160	Electric	Oil Free	015	0	1,5	1,1	2450	230/1/50	8	DOL	68	314 x 200 x 347	5	No
SUITCASE - 0 UK	2236115859	BM	160	Electric	Oil Free	015	0	1,5	1,1	2450	230/1/50	8	DOL	68	314 x 200 x 347	5	No



SUITCASE 6 LT - Special Design

ABAC designers have significantly thought about the innovation of Suitcase air compressor. Although transportation and ease of use are fundamental, compressed air has to be delivered too. This is why SUITCASE 6 LT is provided with universal air outlet, a spiral hose included and a vain where to store air-tool.

Model	Part Number	Configuration	l/min	Engine	Oil	Pump	L	HP	kW	Rpm	Voltz	Bar	Start type	dB(A)	LxWxH (mm)	KG	Dryer
SUITCASE - 6	2236115861	TM	160	Electric	Oil Free	015	6	1,5	1,1	2450	230/1/50	8	DOL	68	325 x 233 x 536	10	No
SUITCASE - 6 UK	2236115862	TM	160	Electric	Oil Free	015	6	1,5	1,1	2450	230/1/50	8	DOL	68	325 x 233 x 536	10	No

VENTO 6 LT - Base Line



VENTO 6 LT is a small and lightweight compressor with a carry handle, included in the Hobby and DIY category and is tailored for hobbyists. By having outstanding features such as ease of use, design and versatility, the products meet the most demanding needs and it is perfect for occasional or intermittent use.

Model	Part Number	Configuration	l/min	Engine	Oil	Pump	L	HP	kW	Rpm	Voltz	Bar	Start type	dB(A)	LxWxH (mm)	KG	Dryer
VENTO B15	1129100008	TM	160	Electric	Oil Free	B15	6	1,5	1,1	2450	230/1/51	8	DOL	85	360 x 300 x 480	11	No
VENTO B15 BASELINE UK	1129100011	TM	160	Electric	Oil Free	B15	6	1,5	1,1	2450	230/1/51	8	DOL	85	360 x 300 x 480	11	No

POLE POSITION 24 LT - Base Line



The ABAC POLE POSITION BASELINE is the ideal solution for occasional use meeting the needs of all hobbyists. Its exceptional features of ease of use, design and versatility make it a product able to meet the most varied needs of use.

Model	Part Number	Configuration	l/min	Engine	Oil	Pump	L	HP	kW	Rpm	Voltz	Bar	Start type	dB(A)	LxWxH (mm)	KG	Dryer
POLE POSITION B15 BASELINE	1129100009	TM	160	Electric	Oil Free	B15	24	1,5	1,1	2450	230/1/50	8	DOL	85	610 x 320 x 590	18	No
POLE POSITION B15 BASELINE UK	1129100017	TM	160	Electric	Oil Free	B15	24	1,5	1,1	2450	230/1/50	8	DOL	85	610 x 320 x 590	18	No
POLE POSITION B20 BASELINE	1129100007	TM	190	Electric	ALTAIR PRO	B20	24	2	1,5	2850	230/1/50	8	DOL	85	610 x 310 x 580	24	No
POLE POSITION B20 BASELINE	1129781008	TM	190	Electric	ALTAIR PRO	B20	24	2	1,5	2850	230/1/50	8	DOL	85	610 x 310 x 580	24	No
POLE POSITION B20 BASELINE UK	1129981010	TM	190	Electric	ALTAIR PRO	B20	24	2	1,5	2850	230/1/50	8	DOL	85	610 x 310 x 580	24	No

MONTECARLO 50 LT - Base Line



The MONTECARLO BASELINE is included in the Hobby and DIY category and is tailored for hobbyists. By having outstanding features such as ease of use, design and versatility, the products meet the most demanding needs. The range 50 L 2 HP is perfect for occasional or intermittent use.

Model	Part Number	Configuration	l/min	Engine	Oil	Pump	L	HP	kW	Rpm	Voltz	Bar	Start type	dB(A)	LxWxH (mm)	KG	Dryer
MONTECARLO B20 BASELINE	1129100006	TM	190	Electric	ALTAIR PRO	B20	50	2	1,5	2850	230/1/50	8	DOL	85	770 x 430 x 660	32	No
MONTECARLO B20 BASELINE	1129781009	TM	190	Electric	ALTAIR PRO	B20	50	2	1,5	2850	230/1/50	8	DOL	85	770 x 430 x 660	32	No
MONTECARLO B20 BASELINE UK	1129981011	TM	190	Electric	ALTAIR PRO	B20	50	2	1,5	2850	230/1/50	8	DOL	85	770 x 430 x 660	32	No



START 6 LT - Line

The ABAC START 6 LT has been designed for advanced amateurs, but it is also an excellent solution for hobbyists thanks to its efficiency and convenient transport characteristics: it is ideal for occasional or intermittent use.

Its oil injected configuration, in addition to reducing management costs, will allow you to complete simple maintenance operations easily and quickly.

Model	Part Number	Configuration	l/min	Engine	Oil	Pump	L	HP	kW	Rpm	Voltz	Bar	Start type	dB(A)	LxWxH (mm)	KG	Dryer
START L20	1129100034	TM	220	Electric	ALTAIR PRO	L20	6	2	1,5	2850	230/1/50	8	DOL	70	400 x 280 x 480	14	No
START L20 60HZ	1129102617	TM	220	Electric	ALTAIR PRO	L20	6	2	1,5	2850	230/1/60	8	DOL	70	400 x 280 x 480	14	No



POLE POSITION 24 LT - Line

POLE POSITION 24 LT , is included in the professional mobile category and tailored for advanced amateurs. However, features such as efficiency and ease of transportation, make it a suitable option for hobbyists as well. This range of compressors has robust and strong direct driven pumps for easier use, and they have extra benefits to improve the user comfort.

Model	Part Number	Configuration	l/min	Engine	Oil	Pump	L	HP	kW	Rpm	Voltz	Bar	Start type	dB(A)	LxWxH (mm)	KG	Dryer
POLE POSITION L20	1129100021	TM	220	Electric	ALTAIR PRO	L20	24	2	1,5	2850	230/1/50	10	DOL	70	610 x 320 x 580	25	No
POLE POSITION L20 60HZ	1129102618	TM	220	Electric	ALTAIR PRO	L20	24	2	1,5	2850	230/1/60	10	DOL	70	610 x 320 x 580	25	No
POLE POSITION L20 60HZ	1129102642	TM	220	Electric	ALTAIR PRO	L20	24	2	1,5	2850	230/1/60	10	DOL	70	610 x 320 x 580	25	No
POLE POSITION L20 60HZ	1129102867	TM	220	Electric	ALTAIR PRO	L20	24	2	1,5	2850	230/1/60	10	DOL	70	610 x 320 x 580	25	No
POLE POSITION L25P	1129100042	TM	270	Electric	ALTAIR PRO	L25P	24	2,5	1,9	2850	230/1/50	10	DOL	70	630 x 320 x 620	28	No
POLE POSITION L30P	1129100045	TM	310	Electric	ALTAIR PRO	L30P	24	3	2,2	2850	230/1/50	10	DOL	75	630 x 320 x 620	29	No



MONTECARLO 50 LT - Line

The MONTECARLO 50 LT -Line is a direct drive air compressor which is ideal if you run nail guns and other small air tools. It has a 50 litre receiver tank which gives you a useful amount of compressed air for most tasks.

Model	Part Number	Configuration	l/min	Engine	Oil	Pump	L	HP	kW	Rpm	Voltz	Bar	Start type	dB(A)	LxWxH (mm)	KG	Dryer
MONTECARLO L20	1129100023	TM	220	Electric	ALTAIR PRO	L20	50	2	1,5	2850	230/1/50	10	DOL	70	770 x 430 x 660	33	No
MONTECARLO L20 60HZ	1129102619	TM	220	Electric	ALTAIR PRO	L20	50	2	1,5	2850	230/1/60	10	DOL	70	770 x 430 x 660	33	No



MONTECARLO 50 LT - Line

The MONTECARLO 50 LT -Line is a direct drive air compressor which is ideal if you run nail guns and other small air tools. It has a 50 litre receiver tank which gives you a useful amount of compressed air for most tasks.

Model	Part Number	Configuration	l/min	Engine	Oil	Pump	L	HP	kW	Rpm	Voltz	Bar	Start type	dB(A)	LxWxH (mm)	KG	Dryer
MONTECARLO L20 60HZ	1129740724	TM	220	Electric	ALTAIR PRO	L20	50	2	1,5	2850	230/1/60	10	DOL	70	770 x 430 x 660	33	No
MONTECARLO L25P	1129100048	TM	270	Electric	ALTAIR PRO	L25P	50	2,5	1,9	2850	230/1/50	10	DOL	70	940 x 320 x 700	36	No
MONTECARLO L30P	1129100037	TM	310	Electric	ALTAIR PRO	L30P	50	3	2,2	2850	230/1/50	10	DOL	73	940 x 320 x 700	37	No



V36 50 LT - Line

The ABAC V36/50 CM3 piston air compressor is designed for advanced amateurs. Its exceptional characteristics of efficiency and convenience of transport make it a product able to satisfy the most varied needs of use.

Model	Part Number	Configuration	l/min	Engine	Oil	Pump	L	HP	kW	Rpm	Voltz	Bar	Start type	dB(A)	LxWxH (mm)	KG	Dryer
V 36/50 ABAC	1129981051	TM	355	Electric	ALTAIR	V36	50	3	2,2	2850	230/1/50	10	DOL	87	710 x 330 x 620	42	No



START ROLLCAGE 9 LT - Pro Line

START ROLLCAGE 9 LT - Pro Line is a 2.5 HP lubricated direct drive unit mounted on a 9 litre receiver within a rollcage carry frame. This range of compressors has robust and strong direct driven pumps for more intensive use, and they have extra benefits to improve the user comfort.

Model	Part Number	Configuration	l/min	Engine	Oil	Pump	L	HP	kW	Rpm	Voltz	Bar	Start type	dB(A)	LxWxH (mm)	KG	Dryer
START ROLLCAGE L25P	1129100051	TM	270	Electric	ALTAIR PRO	L25P	9	2,5	1,9	2850	230/1/50	10	DOL	70	455 x 475 x 500	24	No



PORTABLE ROLLCAGE 9 LT - Pro Line

This machine also features the roll cage configuration that offers maximum protection during transportation. It can be rolled on its sturdy wheels, or lifted with the carrying handle. It also features clear gauges and integrated regulators.

Model	Part Number	Configuration	l/min	Engine	Oil	Pump	L	HP	kW	Rpm	Voltz	Bar	Start type	dB(A)	LxWxH (mm)	KG	Dryer
PORTABLE ROLLCAGE L30P	1129100060	TM	310	Electric	ALTAIR PRO	L30P	9	3	2,2	2850	230/1/50	10	DOL	75	490 x 520 x 560	29	No



SILVERSTONE 10 LT - Pro Line

SILVERSTONE 10 LT - Pro Line is a 2.5 HP lubricated direct drive unit mounted on a 10 litre receiver. This range of compressors has robust and strong direct driven pumps for more intensive use, and they have extra benefits to improve the user comfort.

Model	Part Number	Configuration	l/min	Engine	Oil	Pump	L	HP	kW	Rpm	Voltz	Bar	Start type	dB(A)	LxWxH (mm)	KG	Dryer
SILVERSTONE L25P	1129100062	TM	270	Electric	ALTAIR PRO	L25P	10	2,5	1,9	2850	230/1/50	10	DOL	70	420 x 330 x 635	24	No



HOCKENHEIM 20 LT - Pro Line

HOCKENHEIM 20 LT - Pro Line is compact, but has a 3 HP motor with high output, and a unique design which enables it to be pulled during transportation. It also features a 20 litre receiver, and noise reducing dampers.

Model	Part Number	Configuration	l/min	Engine	Oil	Pump	L	HP	kW	Rpm	Voltz	Bar	Start type	dB(A)	LxWxH (mm)	KG	Dryer
HOCKENHEIM L30P	1129100063	TM	310	Electric	ALTAIR PRO	L30P	20	3	2,2	2850	230/1/50	10	DOL	75	520 x 430 x 790	35	No



ESTORIL 90 LT - Pro Line

With its innovative design, the ESTORIL 90 LT - Pro Line ensures the excellent performance of the coaxial pump with larger tank storage and good mobility thanks to its wheels and upper handle.

Model	Part Number	Configuration	l/min	Engine	Oil	Pump	L	HP	kW	Rpm	Voltz	Bar	Start type	dB(A)	LxWxH (mm)	KG	Dryer
ESTORIL L30P	1121390600	TM	310	Electric	ALTAIR PRO	L30P	90	3	2,2	2850	230/1/50	10	DOL	73	1200 x 400 x 850	63	No



V30 11+11 LT - Pro Line

The ABAC V30 11+11 LT - Pro Line is a direct drive piston compressor with a reduced footprint for space optimisation, an extra tray to stock material and equipment and an extendible handle with rubber grip.

Model	Part Number	Configuration	l/min	Engine	Oil	Pump	L	HP	kW	Rpm	Voltz	Bar	Start type	dB(A)	LxWxH (mm)	KG	Dryer
V30/11+11 CM 3	1121440197	TM	330	Electric	ALTAIR	V30	22	3	2,2	1450	230/1/50	10	DOL	72	770 x 610 x 540	50	No



V30 20 LT - Pro Line

High performance direct drive compressor range designed for more intensive usage. A portable air compressor mounted on wheels, and a robust roll bar frame make this an ideal unit for the tradesman who moves around various sites.

Model	Part Number	Configuration	l/min	Engine	Oil	Pump	L	HP	kW	Rpm	Voltz	Bar	Start type	dB(A)	LxWxH (mm)	KG	Dryer
V30/20 PCM 3	1121090851	TM	330	Electric	ALTAIR	V30	20	3	2,2	1450	230/1/50	10	DOL	70	520 x 430 x 790	43	No



V30 50 LT - Pro Line

High performance direct drive compressor range designed for more intensive usage. This is a portable electric air compressor with 50 litre receiver in a conventional configuration. It is mounted on wheels and has a robust handle to make this an ideal unit for moving around the workshop.

Model	Part Number	Configuration	l/min	Engine	Oil	Pump	L	HP	kW	Rpm	Voltz	Bar	Start type	dB(A)	LxWxH (mm)	KG	Dryer
V30/50 CM 3	1121360249	TM	330	Electric	ALTAIR	V30	50	3	2,2	1450	230/1/50	10	DOL	72	800 x 380 x 680	60	No



V30 50 LT VERTICAL - Pro Line

High performance direct drive compressor range designed for more intensive usage. A portable compressor with 50 litre receiver in a vertical configuration mounted on wheels, and a robust handle make this an ideal unit for moving around the workshop.

Model	Part Number	Configuration	l/min	Engine	Oil	Pump	L	HP	kW	Rpm	Voltz	Bar	Start type	dB(A)	LxWxH (mm)	KG	Dryer
V30/50 VERTICAL CM3	1121430329	TM	330	Electric	ALTAIR	V30	50	3	2,2	1450	230/1/50	10	DOL	70	520 x 410 x 1100	62	No



V30 90 LT - Pro Line

High performance direct drive compressor range designed for more intensive usage. A portable compressor with 90 litre receiver in a conventional configuration mounted on wheels, and a robust handle make this an ideal unit for moving around the workshop.

Model	Part Number	Configuration	l/min	Engine	Oil	Pump	L	HP	kW	Rpm	Voltz	Bar	Start type	dB(A)	LxWxH (mm)	KG	Dryer
V30/90 CM 3	1121370226	TM	330	Electric	ALTAIR	V30	90	3	2,2	1450	230/1/50	10	DOL	72	1200 x 400 x 830	72	No



START 6 LT - Semi Silent

The ABAC START 6 LT - Semi Silent compressor packs a lot of strength: when space is limited, it delivers up to 10 bar of pressure in a compact unit.

Model	Part Number	Configuration	l/min	Engine	Oil	Pump	L	HP	kW	Rpm	Voltz	Bar	Start type	dB(A)	LxWxH (mm)	KG	Dryer
START OSS 10P	1129741032	TM	108	Electric	Oil Free	OSS10P	6	1	0,7	1450	230/1/50	10	DOL	60	327 x 307 x 505	19	No
START OSS 20P	1129741045	TM	222	Electric	Oil Free	OSS20P	6	2	1,5	2900	230/1/50	10	DOL	68	327 x 307 x 505	19	No



SILVERSTONE 10 LT - Semi Silent

With a double hook to hold cables in place and an ergonomic handle for added comfort, the SILVERSTONE 10 LT - Semi Silent is a wheeled compressor easy to move.

Model	Part Number	Configuration	l/min	Engine	Oil	Pump	L	HP	kW	Rpm	Voltz	Bar	Start type	dB(A)	LxWxH (mm)	KG	Dryer
SILVERSTONE OSS20P	1129741048	TM	222	Electric	Oil Free	OSS20P	10	2	1,5	2900	230/1/50	10	DOL	68	400 x 347 x 630	22	No



POLE POSITION 24 LT - Semi Silent

The POLE POSITION 24 LT - Semi Silent is equipped with a built-in pump to reduce noise and increase safety. All that is needed for plug and play operation is a single phase power supply.

Model	Part Number	Configuration	l/min	Engine	Oil	Pump	L	HP	kW	Rpm	Voltz	Bar	Start type	dB(A)	LxWxH (mm)	KG	Dryer
POLE POSITION OSS20P	1129741053	TM	222	Electric	Oil Free	OSS20P	24	2	1,5	2900	230/1/50	10	DOL	72	554 x 300 x 610	23	No

MONTECARLO 50 LT - Semi Silent



The flagship of the OS Silent range, the MONTECARLO 50 LT oil-free piston compressor is nearly maintenance free, improves efficiency and lowers running costs.

Model	Part Number	Configuration	l/min	Engine	Oil	Pump	L	HP	kW	Rpm	Voltz	Bar	Start type	dB(A)	LxWxH (mm)	KG	Dryer
MONTECARLO OSS20P	1129741059	TM	222	Electric	Oil Free	OSS20P	50	2	1,5	2900	230/1/50	10	DOL	72	807 x 385 x 646	34	No



START SILENT 6 LT - Super Silent

The ABAC START SILENT 6 LT - Super Silent piston air compressor has been designed for advanced amateurs, however it is also an excellent solution for hobbyists thanks to its efficiency and transport comfort characteristics. This compressor range is ideal for occasional or intermittent use.

Model	Part Number	Configuration	l/min	Engine	Oil	Pump	L	HP	kW	Rpm	Voltz	Bar	Start type	dB(A)	LxWxH (mm)	KG	Dryer
START SILENT OS7P	1129740290	TM	140	Electric	Oil Free	OS7P	6	0,75	0,6	1420	230/1/50	8	DOL	63	363 x 279 x 521	17	No
START SILENT OS10P	1129740325	TM	165	Electric	Oil Free	OS10P	6	1	0,7	1420	230/1/50	9	DOL	63	363 x 279 x 521	17	No
START SILENT OS15P	1129740291	TM	195	Electric	Oil Free	OS15P	6	1,5	1,1	1420	230/1/50	9	DOL	65	363 x 279 x 521	19	No
START SILENT OS20P	1129740292	TM	230	Electric	Oil Free	OS20P	6	2	1,5	1420	230/1/50	9	DOL	65	363 x 279 x 521	19	No



PORTABLE ROLLCAGE 9 LT - Super Silent

The ABAC PORTABLE ROLLCAGE 9 LT - Super Silent piston air compressor has been designed for advanced amateurs, however it is also an excellent solution for hobbyists thanks to the characteristics of efficiency and transport comfort thanks to its portable configuration.

Model	Part Number	Configuration	l/min	Engine	Oil	Pump	L	HP	kW	Rpm	Voltz	Bar	Start type	dB(A)	LxWxH (mm)	KG	Dryer
PORTABLE ROLLCAGE OS20P	1129740300	TM	230	Electric	Oil Free	OS20P	9	2	1,5	1420	230/1/50	9	DOL	65	497 x 480 x 477	34	No



GO CART 15 LT - Super Silent

The GO CART 15 LT - Super Silent is a user friendly compressor thanks to the clear and nicely designed regulators and foldable high handle.

Model	Part Number	Configuration	l/min	Engine	Oil	Pump	L	HP	kW	Rpm	Voltz	Bar	Start type	dB(A)	LxWxH (mm)	KG	Dryer
GO CART OS20P	1129740614	TM	230	Electric	Oil Free	OS20P	15	2	1,5	1420	230/1/50	9	DOL	65	573 x 620 x 873	41	No



SILVERSTONE 10 LT - Super Silent

Thanks to the double hook to keep cables in place and the ergonomic handle for extra user comfort, the SILVERSTONE 10 LT - Super Silent is a good solution for advanced amateurs and hobbyists.

Model	Part Number	Configuration	l/min	Engine	Oil	Pump	L	HP	kW	Rpm	Voltz	Bar	Start type	dB(A)	LxWxH (mm)	KG	Dryer
SILVERSTONE OS15P	1129740330	TM	195	Electric	Oil Free	OS15P	10	1,5	1,1	1420	230/1/50	9	DOL	65	398 x 332 x 627	24	No
SILVERSTONE OS15P UK	1129740333	TM	195	Electric	Oil Free	OS15P	10	1,5	1,1	1420	230/1/50	9	DOL	65	398 x 332 x 627	24	No
SILVERSTONE OS20P	1129740295	TM	230	Electric	Oil Free	OS20P	10	2	1,5	1420	230/1/50	9	DOL	65	398 x 332 x 627	24	No



HOCKENHEIM 20 LT - Super Silent

The ABAC HOCKENHEIM 20 LT - Super Silent piston air compressor has been designed for advanced amateurs and hobbyists, thanks to the ergonomic handle for extra user comfort and the enclosed pump to reduce noise and improve safety.

Model	Part Number	Configuration	l/min	Engine	Oil	Pump	L	HP	kW	Rpm	Voltz	Bar	Start type	dB(A)	LxWxH (mm)	KG	Dryer
HOCKENHEIM OS15P	1129740335	TM	195	Electric	Oil Free	OS15P	20	1,5	1,1	1420	230/1/50	9	DOL	65	479 x 385 x 793	33	No
HOCKENHEIM OS20P	1129740336	TM	230	Electric	Oil Free	OS20P	20	2	1,5	1420	230/1/50	9	DOL	65	479 x 385 x 793	33	No



POLE POSITION 24 LT - Super Silent

Try the POLE POSITION 24 LT - Super Silent for an oilless air compressor with great performance. The POLE POSITION 24 TL - Super Silent is an oil free and they combine more power with more features. If you do a lot of DIY and you need a compressor that is powerful enough for the job, this is the ideal product. These oil free, direct driven compressors are also a good match for semi-professional applications so they offer you a great deal of flexibility.

Model	Part Number	Configuration	l/min	Engine	Oil	Pump	L	HP	kW	Rpm	Voltz	Bar	Start type	dB(A)	LxWxH (mm)	KG	Dryer
POLE POSITION OS15P	1129740296	TM	195	Electric	Oil Free	OS15P	24	1,5	1,1	1420	230/1/50	9	DOL	65	616 x 300 x 574	24	No
POLE POSITION OS15P UK	1129740340	TM	195	Electric	Oil Free	OS15P	24	1,5	1,1	1420	230/1/50	9	DOL	65	616 x 300 x 574	24	No
POLE POSITION OS20P	1129740297	TM	230	Electric	Oil Free	OS20P	24	2	1,5	1420	230/1/50	9	DOL	65	616 x 300 x 574	24	No
POLE POSITION OS20P UK	1129740341	TM	230	Electric	Oil Free	OS20P	24	2	1,5	1420	230/1/50	9	DOL	65	616 x 300 x 574	24	No



MONTECARLO 50 LT - Super Silent

With a simple on/off push button and easy pressure setting, the MONTECARLO 50 LT - Super Silent piston air compressor has been designed for advanced hobbyists, however it is an excellent solution even for less experienced hobbyists thanks to its efficiency and ease of transport.

Model	Part Number	Configuration	l/min	Engine	Oil	Pump	L	HP	kW	Rpm	Voltz	Bar	Start type	dB(A)	LxWxH (mm)	KG	Dryer
MONTECARLO OS15P	1129740298	TM	195	Electric	Oil Free	OS15P	50	1,5	1,1	1420	230/1/50	9	DOL	65	806 x 385 x 609	32	No
MONTECARLO OS15P UK	1129740342	TM	195	Electric	Oil Free	OS15P	50	1,5	1,1	1420	230/1/50	9	DOL	65	806 x 385 x 609	32	No
MONTECARLO OS20P	1129740299	TM	230	Electric	Oil Free	OS20P	50	2	1,5	1420	230/1/50	9	DOL	65	806 x 385 x 609	32	No



CLR 25 LT - Clean Air

Our CleanAir range is ideally suited to Dental or Laboratory applications which demand Oil Free Air to ensure no contamination of the compressed air and peace of mind to the user. With Epoxy coated air receivers both internally and externally you can be assured of no contamination by corrosion and extended lifetime of the air receiver.

Model	Part Number	Configuration	l/min	Engine	Oil	Pump	L	HP	kW	Rpm	Voltz	Bar	Start type	dB(A)	LxWxH (mm)	KG	Dryer
CLR 15/25 T.	4116092256	TM	240	Electric	Oil Free	CLR15	25	1,5	1,1	1400	230/1/50	8	DOL	70,8	525 x 470 x 665	43	Yes
CLR 20/25.	4116092257	TM	350	Electric	Oil Free	CLR20	25	2	1,5	1400	230/1/50	8	DOL	64,1	470 x 470 x 700	36	No
CLR 20/25 T	4116092258	TM	350	Electric	Oil Free	CLR20	25	2	1,5	1400	230/1/50	8	DOL	64,1	550 x 470 x 700	50	Yes



CLR 30 LT - Clean Air

Our CleanAir range is ideally suited to Dental or Laboratory applications which demand Oil Free Air to ensure no contamination of the compressed air and peace of mind to the user. With Epoxy coated air receivers both internally and externally you can be assured of no contamination by corrosion and extended lifetime of the air receiver. Selecting a model with a desiccant air dryer fitted for removal of water down to a -40°C pressure dewpoint will ensure no bacterial growth can occur and ensures compliance with the requirements of HTM2022 for Dental Applications. The direct drive low noise pump unit is fairly quiet to start with however if noise is an issue and the unit needs to be located close to the point of use then choose an enclosed cabinet silenced model which brings the noise level down to conversation levels.

Model	Part Number	Configuration	l/min	Engine	Oil	Pump	L	HP	kW	Rpm	Voltz	Bar	Start type	dB(A)	LxWxH (mm)	KG	Dryer
CLR 15/30 S T.	4116092268	TMD	240	Electric	Oil Free	CLR15	30	1,5	1,1	1400	230/1/50	8	DOL	70,8	730 x 440 x 760	75	Yes
CLR 15/30 S.	4116092267	TM	240	Electric	Oil Free	CLR15	30	1,5	1,1	1400	230/1/50	8	DOL	70,8	650 x 440 x 760	68	No
CLR 20/30 S T	4116092270	TMD	350	Electric	Oil Free	CLR20	30	2	1,5	1400	230/1/50	8	DOL	73,6	730 x 440 x 760	74	Yes
CLR 20/30 S	4116092269	TM	350	Electric	Oil Free	CLR20	30	2	1,5	1400	230/1/50	8	DOL	73,6	650 x 440 x 760	71,5	No



CLR 50 LT - Clean Air

Our CleanAir range is ideally suited to Dental or Laboratory applications which demand Oil Free Air to ensure no contamination of the compressed air and peace of mind to the user. With Epoxy coated air receivers both internally and externally you can be assured of no contamination by corrosion and extended lifetime of the air receiver. Selecting a model with a desiccant air dryer fitted for removal of water down to a -40°C pressure dewpoint will ensure no bacterial growth can occur and ensures compliance with the requirements of HTM2022 for Dental Applications. The direct drive low noise pump unit is fairly quiet to start with however if noise is an issue and the unit needs to be located close to the point of use then choose an enclosed cabinet silenced model which brings the noise level down to conversation levels.

Model	Part Number	Configuration	l/min	Engine	Oil	Pump	L	HP	kW	Rpm	Voltz	Bar	Start type	dB(A)	LxWxH (mm)	KG	Dryer
CLR 15/50 T.	4116092260	TM	350	Electric	Oil Free	CLR15	50	1,5	1,1	1400	230/1/50	8	DOL	64,1	600 x 470 x 850	47	Yes
CLR 15/50	4116092259	TM	350	Electric	Oil Free	CLR15	50	1,5	1,1	1400	230/1/50	8	DOL	64,1	450 x 470 x 850	36	No
CLR 20/50 T.	4116092262	TM	350	Electric	Oil Free	CLR20	50	2	1,5	1400	230/1/50	8	DOL	73,6	600 x 470 x 850	54	Yes
CLR 20/50 .	4116092261	TM	350	Electric	Oil Free	CLR20	50	2	1,5	1400	230/1/50	8	DOL	73,6	450 x 470 x 850	40	No
CLR 25/50 T	4116092290	TM	480	Electric	Oil Free	CLR25	50	2,5	1,9	1400	230/1/50	8	DOL	77	640 x 470 x 890	60	Yes
CLR 25/50	4116092289	TM	480	Electric	Oil Free	CLR25	50	2,5	1,9	1400	230/1/50	8	DOL	77	640 x 470 x 890	52	No

CNR 0 LT - Clean Air



The ABAC CNR 0 LT - Clean Air is a user-friendly compressor thanks to the central control panel and the metal canopy with insulating foam.

Model	Part Number	Configuration	l/min	Engine	Oil	Pump	L	HP	kW	Rpm	Voltz	Bar	Start type	dB(A)	LxWxH (mm)	KG	Dryer
CNR 75/BM	8115465687	BM	1146	Electric	Oil Free	CNR	0	7,5	5,5	1500	400/3/50	10	Y/D	62	1640 x 1000 x 1040	274	No
CNR 100/BM	8115475439	BM	1146	Electric	Oil Free	CNR	0	10	7,5	1500	400/3/50	10	Y/D	64	1640 x 1000 x 1040	286	No



CNR 270 LT - Clean Air

The ABAC CNR 270 LT - Clean Air is a user-friendly compressor with a 270 litre receiver. Thanks to its smart design, low energy consumption and minimal maintenance requirements, cost and environmental impact are kept at a minimum.

Model	Part Number	Configuration	l/min	Engine	Oil	Pump	L	HP	kW	Rpm	Voltz	Bar	Start type	dB(A)	LxWxH (mm)	KG	Dryer
CNR 75/270	8115465695	TM	1146	Electric	Oil Free	CNR	270	7,5	5,5	1500	400/3/50	10	Y/D	62	2180 x 1000 x 1630	349	No
CNR 100/270	8115475462	TM	1146	Electric	Oil Free	CNR	270	10	7,5	1500	400/3/50	10	Y/D	64	2180 x 1000 x 1630	361	No



CNR 500 LT - Clean Air

The CNR 500 LT - Clean Air comes with advanced electronic control and monitoring: the one-touch controller is easy to use, optimizing both performance and reliability.

Model	Part Number	Configuration	l/min	Engine	Oil	Pump	L	HP	kW	Rpm	Voltz	Bar	Start type	dB(A)	LxWxH (mm)	KG	Dryer
CNR 75/500	8115465703	TM	1146	Electric	Oil Free	CNR	500	7,5	5,5	1500	400/3/50	10	Y/D	62	2180 x 1000 x 1630	394	No
CNR 100/500	8115475496	TM	1146	Electric	Oil Free	CNR	500	10	7,5	1500	400/3/50	10	Y/D	64	2180 x 1000 x 1630	406	No

Piston Compressors Belt Drive 1 Stage



Piston Compressors Belt Drive

1 Stage

Ideal and economic solutions for light-duty tools and occasional use both semi-pro and professional applications.

Oil-Free

Experience the clean and quality air with Abac Zero. Usual ABAC performance, now with less maintenance and zero pollution on condensate, thanks to oilfree pistons.

50

Base Line

Created for reliable solutions on simple jobs. Perfect fit for semi-professional jobs or DIY and domestic use.

53

Line

LINE series stand for a good balance between performance, reliability and basic user comfort. The range offers variable power sizes and tank capabilities to matching your needs.

55

Pro Line

PRO series combine high user comfort with a great durability and efficient performance. All units come with aftercoolers for lower operating temperatures and maximum number of feet with rubber to increase stability.

63

Cast Iron

Take ABAC experience to more extreme environments and work conditions with our durable & robust cast iron selection.

68



ABAC 0 27 LT - Oil-Free

The ABAC 0 27 LT - Oil-Free piston air compressor has been designed for professionals, however it is an excellent solution even for advanced amateurs thanks to its reliability, stability and robustness.

It has an innovative design thanks to the special belt guard design for improved cooling.

Model	Part Number	Configuration	l/min	Engine	Oil	Pump	L	HP	kW	Rpm	Voltz	Bar	Start type	dB(A)	LxWxH (mm)	KG	Dryer
PRO A29B-0 27 CM2	4116000266	TM	255	Electric	Oil Free	A29B-0	27	2	1,5	1075	230/1/50	10	DOL	92,3	810 x 390 x 710	43	No
PRO A29B-0 27 CT2	4116000267	TM	255	Electric	Oil Free	A29B-0	27	2	1,5	1075	400/3/50	10	DOL	92,3	810 x 390 x 710	43	No



ABAC 0 50 LT - Oil-Free

The ABAC 0 50 LT - Oil-Free is a piston air compressor designed for professionals and advanced amateurs. Its oil free configuration, in addition to reducing management costs, will allow the maintenance of a clean workstation.

Model	Part Number	Configuration	l/min	Engine	Oil	Pump	L	HP	kW	Rpm	Voltz	Bar	Start type	dB(A)	LxWxH (mm)	KG	Dryer
PRO A29B-0 50 CM2	4116000268	TM	255	Electric	Oil Free	A29B-0	50	2	1,5	1075	230/1/50	10	DOL	92,3	870 x 370 x 780	49	No
PRO A29B-0 50 CM3	4116000274	TM	320	Electric	Oil Free	A29B-0	50	3	2,2	1300	230/1/50	10	DOL	94,4	940 x 410 x 800	58	No
PRO A29B-0 50 CT2	4116000269	TM	255	Electric	Oil Free	A29B-0	50	2	1,5	1075	400/3/50	10	DOL	92,3	870 x 370 x 780	49	No
PRO A29B-0 50 CT3	4116000275	TM	320	Electric	Oil Free	A29B-0	50	3	2,2	1300	400/3/50	10	DOL	95,6	940 x 410 x 800	58	No



ABAC 0 100 LT - Oil-Free

The ABAC 0 100 LT - Oil-Free range comes with large wheels for stable operations and a double outlet. With its special belt guard design improves the air cooling.

Model	Part Number	Configuration	l/min	Engine	Oil	Pump	L	HP	kW	Rpm	Voltz	Bar	Start type	dB(A)	LxWxH (mm)	KG	Dryer
PRO A29B-0 100 CM2	4116000270	TM	255	Electric	Oil Free	A29B-0	100	2	1,5	1075	230/1/50	10	DOL	92,3	1010 x 415 x 900	56	No
PRO A29B-0 100 CM3	4116000276	TM	320	Electric	Oil Free	A29B-0	100	3	2,2	1300	230/1/50	10	DOL	94,4	1010 x 415 x 900	56	No
PRO A29B-0 100 CT2	4116000271	TM	255	Electric	Oil Free	A29B-0	100	2	1,5	1075	400/3/50	10	DOL	92,3	1010 x 415 x 900	56	No
PRO A29B-0 100 CT3	4116000277	TM	320	Electric	Oil Free	A29B-0	100	3	2,2	1300	400/3/50	10	DOL	95,6	1010 x 415 x 900	56	No
PRO A39B-0 100 CM3	4116000284	TM	393	Electric	Oil Free	A39B-0	100	3	2,2	1050	230/1/50	10	DOL	96	1180 x 460 x 930	72	No



ABAC 0 100 LT - Oil-Free

The ABAC 0 100 LT - Oil-Free range comes with large wheels for stable operations and a double outlet. With its special belt guard design improves the air cooling.

Model	Part Number	Configuration	l/min	Engine	Oil	Pump	L	HP	kW	Rpm	Voltz	Bar	Start type	dB(A)	LxWxH (mm)	KG	Dryer
PRO A39B-0 100 CT3	4116000285	TM	393	Electric	Oil Free	A39B-0	100	3	2,2	1050	400/3/50	10	DOL	96	1180 x 460 x 930	72	No

ABAC 0 150 LT - Oil-Free



Thanks to the cast iron cylinder and the pivoting locking wheel, the ABAC 0 150 LT - Oil-Free is a user friendly and reliable piston air compressor.

Model	Part Number	Configuration	l/min	Engine	Oil	Pump	L	HP	kW	Rpm	Voltz	Bar	Start type	dB(A)	LxWxH (mm)	KG	Dryer
PRO A29B-0 150 CM2	4116000272	TM	255	Electric	Oil Free	A29B-0	150	2	1,5	1075	230/1/50	10	DOL	92,3	1375 x 420 x 950	87	No
PRO A29B-0 150 CM3	4116000278	TM	320	Electric	Oil Free	A29B-0	150	3	2,2	1300	230/1/50	10	DOL	94,4	1375 x 420 x 950	87	No
PRO A29B-0 150 CT2	4116000273	TM	255	Electric	Oil Free	A29B-0	150	2	1,5	1075	400/3/50	10	DOL	92,3	1375 x 420 x 950	87	No
PRO A29B-0 150 CT3	4116000279	TM	320	Electric	Oil Free	A29B-0	150	3	2,2	1300	400/3/50	10	DOL	95,6	1375 x 420 x 950	87	No
PRO A39B-0 150 CM3	4116000286	TM	393	Electric	Oil Free	A39B-0	150	3	2,2	1050	230/1/50	10	DOL	94,4	1375 x 420 x 950	87	No
PRO A39B-0 150 CT3	4116000287	TM	393	Electric	Oil Free	A39B-0	150	3	2,2	1050	400/3/50	10	DOL	95,6	1375 x 420 x 950	87	No

ABAC 0 200 LT - Oil-Free



With its proven and reliable technology, the ABAC 0 200 LT - Oil-Free piston air compressor is an excellent solution for professionals and also advanced amateurs thanks to the characteristics of reliability, stability and robustness.

Model	Part Number	Configuration	l/min	Engine	Oil	Pump	L	HP	kW	Rpm	Voltz	Bar	Start type	dB(A)	LxWxH (mm)	KG	Dryer
PRO A29B-0 200 CM3	4116000280	TM	320	Electric	Oil Free	A29B-0	200	3	2,2	1300	230/1/50	10	DOL	94,4	1500 x 470 x 1110	91	No
PRO A29B-0 200 CT3	4116000281	TM	320	Electric	Oil Free	A29B-0	200	3	2,2	1300	400/3/50	10	DOL	95,6	1500 x 470 x 1110	91	No
PRO A39B-0 200 CM3	4116000288	TM	393	Electric	Oil Free	A39B-0	200	3	2,2	1050	230/1/50	10	DOL	94,4	1500 x 470 x 1110	91	No
PRO A39B-0 200 CT3	4116000289	TM	393	Electric	Oil Free	A39B-0	200	3	2,2	1050	400/3/50	10	DOL	95,6	1500 x 470 x 1110	91	No



ABAC 0 200 LT - Oil-Free

With its proven and reliable technology, the ABAC 0 200 LT - Oil-Free piston air compressor is an excellent solution for professionals and also advanced amateurs thanks to the characteristics of reliability, stability and robustness.

Model	Part Number	Configuration	l/min	Engine	Oil	Pump	L	HP	KW	Rpm	Voltz	Bar	Start type	dB(A)	LxWxH (mm)	KG	Dryer
PRO A39B-0 200 CT4	4116000292	TM	486	Electric	Oil Free	A39B-0	200	4	3	1300	400/3/50	10	DOL	95,6	1530 x 595 x 1160	138	No



ABAC 0 270 LT - Oil-Free

The ABAC 0 270 LT - Oil-Free piston air compressor is easy to transport thanks to its mobile configuration. It has been designed both for professionals and advanced amateurs thanks to its reliability, stability and robustness.

Model	Part Number	Configuration	l/min	Engine	Oil	Pump	L	HP	KW	Rpm	Voltz	Bar	Start type	dB(A)	LxWxH (mm)	KG	Dryer
PRO A39B-0 270 CM3	4116000290	TM	393	Electric	Oil Free	A39B-0	270	3	2,2	1050	230/1/50	10	DOL	94,4	1530 x 595 x 1160	138	No
PRO A39B-0 270 CT3	4116000291	TM	393	Electric	Oil Free	A39B-0	270	3	2,2	1050	400/3/50	10	DOL	95,6	1530 x 595 x 1160	138	No
PRO A39B-0 270 CT4	4116000293	TM	486	Electric	Oil Free	A39B-0	270	4	3	1300	400/3/50	10	DOL	95,6	1530 x 595 x 1160	138	No



B26 50 LT - Base Line

B26 BASELINE is for hobby or light domestic use. The larger air receiver provides the capacity to run small air tools, but still with the advantage of portability.

Model	Part Number	Configuration	l/min	Engine	Oil	Pump	L	HP	kW	Rpm	Voltz	Bar	Start type	dB(A)	LxWxH (mm)	KG	Dryer
B26/50CM2 230/50CE BASELINE	1121450003	TM	210	Electric	ALTAIR PRO	B26	50	2	1,5	1400	230/1/50	10	DOL	93	1010 x 360 x 730	50	No



B26B 90 LT - Base Line

B26 BASELINE has all the advantages of the belt driven range, but with the benefit of an even larger air receiver, still portable, but with the extra capacity for more applications.

Model	Part Number	Configuration	l/min	Engine	Oil	Pump	L	HP	kW	Rpm	Voltz	Bar	Start type	dB(A)	LxWxH (mm)	KG	Dryer
B26/90CM2 230/50CE BASELINE	1121450004	TM	210	Electric	ALTAIR PRO	B26B	90	2	1,5	1400	230/1/50	10	DOL	93	1100 x 400 x 830	62	No
B26B/90CM3 230/50CE BASELINE	1121450005	TM	240	Electric	ALTAIR PRO	B26B	90	3	2,2	1600	230/1/50	10	DOL	92	1100 x 400 x 830	64	No



B26B 150 LT - Base Line

B26 BASELINE with a 150 litre receiver, but is still portable, and will fit in to most small workshops or garages. The 3 HP gives good output, and the extra storage capacity provides extra flexibility for tool usage.

Model	Part Number	Configuration	l/min	Engine	Oil	Pump	L	HP	kW	Rpm	Voltz	Bar	Start type	dB(A)	LxWxH (mm)	KG	Dryer
B26B/150 CM3 V230 BASELINE	1121450006	TM	240	Electric	ALTAIR PRO	B26B	150	3	2,2	1600	230/1/50	10	DOL	92	1360 x 540 x 1060	90	No



B26B 200 LT - Base Line

The largest receiver in the Baseline range, this machine provides the benefits of the extra storage capacity, yet still portable, and able to run on a 13 amp plug. Greater storage provides more air tool and spray gun faculty.

Model	Part Number	Configuration	l/min	Engine	Oil	Pump	L	HP	kW	Rpm	Voltz	Bar	Start type	dB(A)	LxWxH (mm)	KG	Dryer
B26B/200 CM3 V230 BASELINE	1121450007	TM	240	Electric	ALTAIR PRO	B26	200	3	2,2	1600	230/1/50	10	DOL	92	1460 x 640 x 1140	102	No



A29 27 LT - Line

The ABAC A29 27 LT - Line is a great belt driven technology for simple but reliable operation. Your workshop deserves professional equipment. This range is suitable for short to more demanding air tool applications yet it's compact size and portability make it a great addition for anyone looking for a compact but powerful unit.

Model	Part Number	Configuration	l/min	Engine	Oil	Pump	L	HP	kW	Rpm	Voltz	Bar	Start type	dB(A)	LxWxH (mm)	KG	Dryer
A29 27 CM2.	4116024261	TM	255	Electric	ALTAIR PRO	A29	27	2	1,5	1075	230/1/50	10	DOL	89,1	810 x 390 x 710	43	No



A29 50 LT - Line

This machine has a 50 litre receiver for a mixture of portability and usability. It has the same belt driven pump unit, with cast iron cylinders, and comes with the double outlet regulator, and sturdy wheels.

Model	Part Number	Configuration	l/min	Engine	Oil	Pump	L	HP	kW	Rpm	Voltz	Bar	Start type	dB(A)	LxWxH (mm)	KG	Dryer
A29 50 CM2 60 ME	4116024802	TM	255	Electric	ALTAIR PRO	A29	50	2	1,5	1075	230/1/60	10	DOL	89,1	870 x 370 x 780	49	No
A29 50 CM2 ISPM	4116024760	TM	255	Electric	ALTAIR PRO	A29	50	2	1,5	1075	230/1/50	10	DOL	89,1	870 x 370 x 780	49	No
A29 50 CM2.E1	4116024262	TM	255	Electric	ALTAIR PRO	A29	50	2	1,5	1075	230/1/50	10	DOL	89,1	870 x 370 x 780	49	No
A29 50 CT2 220/60 ISPM	4116024493	TM	255	Electric	ALTAIR PRO	A29	50	2	1,5	1075	220/3/60	10	DOL	89,1	870 x 370 x 780	49	No
A29/50 CM 2 V115-230/60HZ	4116024129	TM	255	Electric	ALTAIR PRO	A29	50	2	1,5	1075	115-230/1/60	10	DOL	89,1	870 x 370 x 780	49	No



A29 90 LT - Line

This machine has the larger 90 litre receiver, but is still portable with sturdy wheels and handle. The larger air receiver gives more flexibility for air tool usage.

Model	Part Number	Configuration	l/min	Engine	Oil	Pump	L	HP	kW	Rpm	Voltz	Bar	Start type	dB(A)	LxWxH (mm)	KG	Dryer
A29 90 CM2.E1	4116024335	TM	255	Electric	ALTAIR PRO	A29	90	2	1,5	1075	230/1/50	10	DOL	89,1	1010 x 415 x 900	52	No



A29 100 LT - Line

With a standard aftercooler and pivoting locking wheel, the A29 100 LT - Line it has been designed for professionals and advanced amateurs. Its configuration, in addition to reducing management costs, will allow simple maintenance operations to be carried out quickly and easily.

Model	Part Number	Configuration	l/min	Engine	Oil	Pump	L	HP	kW	Rpm	Voltz	Bar	Start type	dB(A)	LxWxH (mm)	KG	Dryer
A29 100 CM2 60HZ ME	4116024803	TM	255	Electric	ALTAIR PRO	A29	100	2	1,5	1075	230/1/60	10	DOL	89,1	1010 x 415 x 900	56	No
A29 100 CM2 ISPM E1	4116024761	TM	255	Electric	ALTAIR PRO	A29	100	2	1,5	1075	230/1/50	10	DOL	89,1	1010 x 415 x 900	56	No
A29 100 CM2 V115/230-60	4116024120	TM	320	Electric	ALTAIR PRO	A29	100	3	2,2	1300	115-230/1/60	10	DOL	89,1	1010 x 415 x 900	56	No
A29 100 CM2.E1	4116024562	TM	255	Electric	ALTAIR PRO	A29	100	2	1,5	1075	230/1/50	10	DOL	89,1	1010 x 415 x 900	56	No



A29 150 LT - Line

This machine has a 150 litre receiver, and is floor mounted on sturdy feet. The size of the receiver gives even more flexibility for air tool usage, but is small and compact, and would fit any workshop or garage.

Model	Part Number	Configuration	l/min	Engine	Oil	Pump	L	HP	kW	Rpm	Voltz	Bar	Start type	dB(A)	LxWxH (mm)	KG	Dryer
A29 150 CM2 60 ME	4116024804	TM	255	Electric	ALTAIR PRO	A29	150	2	1,5	1075	230/1/60	10	DOL	89,1	1375 x 420 x 950	87	No
A29 150 CM2 ISPM	4116024762	TM	255	Electric	ALTAIR PRO	A29	150	2	1,5	1075	230/1/50	10	DOL	89,1	1375 x 420 x 950	87	No
A29 150 CM2.E1	4116024254	TM	255	Electric	ALTAIR PRO	A29	150	2	1,5	1075	230/1/50	10	DOL	89,1	1375 x 420 x 950	87	No



A29B 50 LT - Line

The ABAC A29B 50 LT - Line range is ideal for medium sized garages and workshops. They come with a regulator and gauge so they're simple to control accurately.

Model	Part Number	Configuration	l/min	Engine	Oil	Pump	L	HP	kW	Rpm	Voltz	Bar	Start type	dB(A)	LxWxH (mm)	KG	Dryer
A29B 50 CM2 AUSTRALIA	4116024701	TM	255	Electric	ALTAIR PRO	A29B	50	2	1,5	1075	230/1/50	10	DOL	89,1	870 x 370 x 780	49	No
A29B 50 CM2 NZ	4116024861	TM	255	Electric	ALTAIR PRO	A29B	50	2	1,5	1075	230/1/50	10	DOL	89,1	870 x 370 x 780	49	No
A29B 50 CM3 AUSTRALIA	4116024702	TM	320	Electric	ALTAIR PRO	A29B	50	3	2,2	1300	230/1/50	10	DOL	89,1	940 x 410 x 800	58	No
A29B 50 CM3 NZ	4116024863	TM	320	Electric	ALTAIR PRO	A29B	50	3	2,2	1300	230/1/50	10	DOL	89,1	940 x 410 x 800	58	No



A29B 50 LT - Line

The ABAC A29B 50 LT - Line range is ideal for medium sized garages and workshops. They come with a regulator and gauge so they're simple to control accurately.

Model	Part Number	Configuration	l/min	Engine	Oil	Pump	L	HP	kW	Rpm	Voltz	Bar	Start type	dB(A)	LxWxH (mm)	KG	Dryer
A29B 50 CM3.	4116024257	TM	320	Electric	ALTAIR PRO	A29B	50	3	2,2	1300	230/1/50	10	DOL	89,1	940 x 410 x 800	58	No
A29B 50 CT3	4116024531	TM	320	Electric	ALTAIR PRO	A29B	50	3	2,2	1300	400/3/50	10	DOL	92,5	940 x 410 x 800	58	No



A29B 90 LT - Line

If you need a portable air compressor with a large receiver, the ABAC A29B 90 LT - Line is a popular choice. This model has a 90 litre receiver and runs on mains electrics. You can store enough compressed air so your team can even use it for light duty spraying.

Model	Part Number	Configuration	l/min	Engine	Oil	Pump	L	HP	kW	Rpm	Voltz	Bar	Start type	dB(A)	LxWxH (mm)	KG	Dryer
A29B 90 CM3	4116024363	TM	320	Electric	ALTAIR PRO	A29B	90	3	2,2	1300	230/1/50	10	DOL	89,1	1010 x 415 x 900	65	No
A29B 90 CM3 AUSTRALIA	4116024703	TM	320	Electric	ALTAIR PRO	A29B	90	3	2,2	1300	230/1/50	10	DOL	89,1	1010 x 415 x 900	65	No
A29B 90 CM3 NZ	4116024864	TM	320	Electric	ALTAIR PRO	A29B	90	3	2,2	1300	230/1/50	10	DOL	89,1	1010 x 415 x 900	65	No
A29B 90 CT3 .	4116024518	TM	320	Electric	ALTAIR PRO	A29B	90	3	2,2	1300	400/3/50	10	DOL	92,5	1010 x 415 x 900	65	No
A29B 90 FM3	4116024525	TM	320	Electric	ALTAIR PRO	A29B	90	3	2,2	1300	230/1/50	10	DOL	89,1	1010 x 415 x 900	65	No
A29B 90 FM3 ISPM	4116025457	TM	320	Electric	ALTAIR PRO	A29B	90	3	2,2	1300	230/1/50	10	DOL	89,1	1010 x 415 x 900	65	No
A29B 90 FT3	4116024526	TM	320	Electric	ALTAIR PRO	A29B	90	3	2,2	1300	400/3/50	10	DOL	92,5	1010 x 415 x 900	65	No



A29B 100 LT - Line

The A29B 100 LT - Line is a belt driven compressor with great performance thanks to the standard aftercooler and a slow speed pump that reduces operating temperature.

Model	Part Number	Configuration	l/min	Engine	Oil	Pump	L	HP	kW	Rpm	Voltz	Bar	Start type	dB(A)	LxWxH (mm)	KG	Dryer
A29B/100 CM 3 V230/60 ABAC ME	4116025239	TM	320	Electric	ALTAIR PRO	A29B	100	3	2,2	1300	230/1/60	10	DOL	89,1	1010 x 415 x 900	56	No
A29B 100 CM3	4116024564	TM	320	Electric	ALTAIR PRO	A29B	100	3	2,2	1300	230/1/50	10	DOL	89,1	1010 x 415 x 900	56	No



A29B 100 LT - Line

The A29B 100 LT - Line is a belt driven compressor with great performance thanks to the standard aftercooler and a slow speed pump that reduces operating temperature.

Model	Part Number	Configuration	l/min	Engine	Oil	Pump	L	HP	kW	Rpm	Voltz	Bar	Start type	dB(A)	LxWxH (mm)	KG	Dryer
A29B 100 CM3 ISPM	4116024763	TM	320	Electric	ALTAIR PRO	A29B	100	3	2,2	1300	230/1/50	10	DOL	89,1	1010 x 415 x 900	56	No
A29B 100 CM3 MEC90	4116024272	TM	320	Electric	ALTAIR PRO	A29B	100	3	2,2	1300	230/1/50	10	DOL	89,1	1010 x 415 x 900	56	No
A29B 100 CT3	4116024565	TM	320	Electric	ALTAIR PRO	A29B	100	3	2,2	1300	400/3/50	10	DOL	92,5	1010 x 415 x 900	56	No



A29B 150 LT - Line

The belt-driven ABAC A29B 150 LT - Line is great value for money. This range has a 150 litre receiver and runs on three phase electrics. The machine is compact in size and has a good output from its three horsepower motor.

Model	Part Number	Configuration	l/min	Engine	Oil	Pump	L	HP	kW	Rpm	Voltz	Bar	Start type	dB(A)	LxWxH (mm)	KG	Dryer
A29B 150 CM3	4116024137	TM	320	Electric	ALTAIR PRO	A29B	150	3	2,2	1300	230/1/50	10	DOL	89,1	1375 x 420 x 950	87	No
A29B 150 CM3 ISPM	4116024764	TM	320	Electric	ALTAIR PRO	A29B	150	3	2,2	1300	230/1/50	10	DOL	89,1	1375 x 420 x 950	87	No
A29B 150 CM3 MEC90	4116024274	TM	320	Electric	ALTAIR PRO	A29B	150	3	2,2	1300	230/1/50	10	DOL	89,1	1375 x 420 x 950	87	No
A29B 150 CT3	4116024138	TM	320	Electric	ALTAIR PRO	A29B	150	3	2,2	1300	400/3/50	10	DOL	92,5	1375 x 420 x 950	87	No
A29B 150 FM3	4116024532	TM	320	Electric	ALTAIR PRO	A29B	150	3	2,2	1300	230/1/50	10	DOL	89,1	1375 x 420 x 950	87	No
A29B 150 FT3	4116024533	TM	320	Electric	ALTAIR PRO	A29B	150	3	2,2	1300	400/3/50	10	DOL	92,5	1375 x 420 x 950	87	No
A29B/150 CM 3 V230/60 S/A	4116024136	TM	320	Electric	ALTAIR PRO	A29B	150	3	2,2	1300	230/1/60	10	DOL	89,1	1375 x 420 x 950	87	No



A29B 200 LT - Line

The A29B 200 LT - Line range is ideal for medium sized garages and workshops. They come with a regulator and gauge so they're simple to control accurately.

This model has the largest receiver in this range, at 200 litres. This lets you store the maximum possible quantity of compressed air so your team can run larger air tools for longer.

Model	Part Number	Configuration	l/min	Engine	Oil	Pump	L	HP	kW	Rpm	Voltz	Bar	Start type	dB(A)	LxWxH (mm)	KG	Dryer
A29B 200 CM3	4116024534	TM	320	Electric	ALTAIR PRO	A29B	200	3	2,2	1300	230/1/50	10	DOL	89,1	1500 x 470 x 1110	91	No
A29B 200 CM3 60HZ ME	4116024805	TM	320	Electric	ALTAIR PRO	A29B	200	3	2,2	1300	230/1/60	10	DOL	89,1	1500 x 470 x 1110	91	No
A29B 200 CM3 ISPM	4116024765	TM	320	Electric	ALTAIR PRO	A29B	200	3	2,2	1300	230/1/50	10	DOL	89,1	1500 x 470 x 1110	91	No
A29B 200 CM3 MEC90	4116024276	TM	320	Electric	ALTAIR PRO	A29B	200	3	2,2	1300	230/1/50	10	DOL	89,1	1500 x 470 x 1110	91	No
A29B 200 CT3 .	4116024535	TM	320	Electric	ALTAIR PRO	A29B	200	3	2,2	1300	400/3/50	10	DOL	92,5	1500 x 470 x 1110	91	No
A29B 200 CT3 ISPM	4116024766	TM	320	Electric	ALTAIR PRO	A29B	200	3	2,2	1300	400/3/50	10	DOL	92,5	1500 x 470 x 1110	91	No
A29B 200 CT3 MEC90	4116024277	TM	320	Electric	ALTAIR PRO	A29B	200	3	2,2	1300	400/3/50	10	DOL	92,5	1500 x 470 x 1110	91	No
A29B 200 FM3	4116024544	TM	320	Electric	ALTAIR PRO	A29B	200	3	2,2	1300	230/1/50	10	DOL	89,1	1500 x 450 x 1110	95	No
A29B 200 FM3 ISPM	4116025458	TM	320	Electric	ALTAIR PRO	A29B	200	3	2,2	1300	230/1/50	10	DOL	89,1	1500 x 450 x 1110	95	No
A29B 200 FT3 .	4116024545	TM	320	Electric	ALTAIR PRO	A29B	200	3	2,2	1300	400/3/50	10	DOL	92,5	1500 x 450 x 1110	95	No
A29B 200CM3 230/60S/A	4116024140	TM	320	Electric	ALTAIR PRO	A29B	200	3	2,2	1300	230/1/60	10	DOL	89,1	1500 x 470 x 1110	91	No



A39 50 LT - Line

The ABAC A39 50 LT - Line piston air compressor has been designed for professionals, however it is configured as an excellent solution even for advanced amateurs thanks to its reliability, stability and robustness.

Model	Part Number	Configuration	l/min	Engine	Oil	Pump	L	HP	kW	Rpm	Voltz	Bar	Start type	dB(A)	LxWxH (mm)	KG	Dryer
A39 50 CM3 NZ	4116024862	TM	393	Electric	ALTAIR PRO	A39	50	3	2,2	1050	230/1/50	10	DOL	89,1	940 x 410 x 800	58	No



A39 90 LT - Line

Thanks to the oil injection, the ABAC A39 90 LT - Line piston air compressor guarantees the completion of the required operations as it does not require excessive efforts in addition to those due to routine maintenance.

Model	Part Number	Configuration	l/min	Engine	Oil	Pump	L	HP	KW	Rpm	Voltz	Bar	Start type	dB(A)	LxWxH (mm)	KG	Dryer
A39 90 CM3 E1	4116024519	TM	393	Electric	ALTAIR PRO	A39	90	3	2,2	1050	230/1/50	10	DOL	89,1	1180 x 460 x 930	67	No
A39 90 CT3	4116024520	TM	393	Electric	ALTAIR PRO	A39	90	3	2,2	1050	400/3/50	10	DOL	89,1	1180 x 460 x 930	67	No



A39 100 LT - Line

The ABAC A39 100 LT - Line piston air compressor has been designed for professionals, however it is configured as an excellent solution even for advanced amateurs thanks to its reliability, stability and robustness.

The oil injection guarantees the completion of the required operations as it does not require excessive efforts in addition to those due to routine maintenance.

Model	Part Number	Configuration	l/min	Engine	Oil	Pump	L	HP	KW	Rpm	Voltz	Bar	Start type	dB(A)	LxWxH (mm)	KG	Dryer
A39 100 CM3 .	4116024566	TM	393	Electric	ALTAIR PRO	A39	100	3	2,2	1050	230/1/50	10	DOL	89,1	1180 x 460 x 930	72	No
A39 100 CM3 ISPM	4116024767	TM	393	Electric	ALTAIR PRO	A39	100	3	2,2	1050	230/1/50	10	DOL	89,1	1180 x 460 x 930	72	No
A39 100 CT3 .	4116024567	TM	393	Electric	ALTAIR PRO	A39	100	3	2,2	1050	400/3/50	10	DOL	89,1	1180 x 460 x 930	72	No



A39 150 LT - Line

The A39 150 LT - Line is a reliable and easy to use piston air compressor, designed for professional and advanced amateurs.

Model	Part Number	Configuration	l/min	Engine	Oil	Pump	L	HP	KW	Rpm	Voltz	Bar	Start type	dB(A)	LxWxH (mm)	KG	Dryer
A39 150 CM3 E1	4116024149	TM	393	Electric	ALTAIR PRO	A39	150	3	2,2	1050	230/1/50	10	DOL	89,1	1375 x 420 x 950	87	No
A39 150 CT3	4116024150	TM	393	Electric	ALTAIR PRO	A39	150	3	2,2	1050	400/3/50	10	DOL	89,1	1375 x 420 x 950	87	No



A39 200 LT - Line

With its strong handle and the pivoting locking wheel, the ABAC A39 200 LT - Line it has been designed both for professionals and advanced amateurs, thanks its reliability, stability and robustness.

Model	Part Number	Configuration	l/min	Engine	Oil	Pump	L	HP	kW	Rpm	Voltz	Bar	Start type	dB(A)	LxWxH (mm)	KG	Dryer
A39 200 CM3 E1	4116024151	TM	393	Electric	ALTAIR PRO	A39	200	3	2,2	1050	230/1/50	10	DOL	89,1	1500 x 470 x 1110	91	No
A39 200 CM3 ISPM	4116024768	TM	393	Electric	ALTAIR PRO	A39	200	3	2,2	1050	230/1/50	10	DOL	89,1	1500 x 470 x 1110	91	No
A39 200 CT3	4116024152	TM	393	Electric	ALTAIR PRO	A39	200	3	2,2	1050	400/3/50	10	DOL	89,1	1500 x 470 x 1110	91	No
A39 200 CT3 ISPM	4116024769	TM	393	Electric	ALTAIR PRO	A39	200	3	2,2	1050	400/3/50	10	DOL	89,1	1500 x 470 x 1110	91	No
A39 200 FM3 230/60 S/A	4116024154	TM	393	Electric	ALTAIR PRO	A39	200	3	2,2	1050	230/1/60	10	DOL	89,1	1500 x 450 x 1110	95	No
A39 200 FT3 220/60 S/A	4116024155	TM	393	Electric	ALTAIR PRO	A39	200	3	2,2	1050	220/3/60	10	DOL	89,1	1500 x 450 x 1110	95	No

A39 270 LT - Line



The A39 270 LT - Line is a reliable and user-friendly piston air compressor with a unique innovative belt guard design to improve cooling and full handle for extra solidity.

Model	Part Number	Configuration	l/min	Engine	Oil	Pump	L	HP	kW	Rpm	Voltz	Bar	Start type	dB(A)	LxWxH (mm)	KG	Dryer
A39 270 CM3 230/60 S/A	4116024156	TM	393	Electric	ALTAIR PRO	A39	270	3	2,2	1050	230/1/60	10	DOL	89,1	1530 x 595 x 1160	138	No
A39 270 CM3 E1	4116024548	TM	393	Electric	ALTAIR PRO	A39	270	3	2,2	1050	230/1/50	10	DOL	89,1	1530 x 595 x 1160	138	No
A39 270 CM3 ISPM	4116024770	TM	393	Electric	ALTAIR PRO	A39	270	3	2,2	1050	230/1/50	10	DOL	89,1	1530 x 595 x 1160	138	No
A39 270 CT3 .	4116024549	TM	393	Electric	ALTAIR PRO	A39	270	3	2,2	1050	400/3/50	10	DOL	89,1	1530 x 595 x 1160	138	No
A39 270 FM3 230/60 S/A	4116024160	TM	393	Electric	ALTAIR PRO	A39	270	3	2,2	1050	230/1/60	10	DOL	89,1	1530 x 595 x 1160	138	No
A39 270 FT3 220/60 S/A	4116024159	TM	393	Electric	ALTAIR PRO	A39	270	3	2,2	1050	220/3/60	10	DOL	89,1	1530 x 595 x 1160	138	No



A39B 270 LT - Line

The A39B 270 LT - Line is a reliable and user-friendly piston air compressor with a unique innovative belt guard design to improve cooling and full handle for extra solidity.

Model	Part Number	Configuration	l/min	Engine	Oil	Pump	L	HP	KW	Rpm	Voltz	Bar	Start type	dB(A)	LxWxH (mm)	KG	Dryer
A39B 270 CT4 ISPM	4116024508	TM	486	Electric	ALTAIR PRO	A39B	270	4	3	1300	400/3/50	10	DOL	94,3	1530 x 595 x 1160	138	No



PRO A29B 27 LT - Pro Line

The ABAC PRO A29B 27 LT - Pro Line is a great value belt drive compressor, which is both heavy duty and compact. It is ideal for powering all commonly used air tools and it gives you a perfect combination of features.

Model	Part Number	Configuration	l/min	Engine	Oil	Pump	L	HP	kW	Rpm	Voltz	Bar	Start type	dB(A)	LxWxH (mm)	KG	Dryer
PRO A29B 27 CM2	4116024264	TM	255	Electric	ALTAIR PRO	A29B	27	2	1,5	1075	230/1/50	10	DOL	89,1	810 x 390 x 710	43	No
PRO A29B 27 CT2	4116024265	TM	255	Electric	ALTAIR PRO	A29B	27	2	1,5	1075	400/3/50	10	DOL	89,1	810 x 390 x 710	43	No



PRO A29B 50 LT - Pro Line

If you need a portable air compressor for your workshop, the belt-driven ABAC PRO A29B 50 LT - Pro Line is great value for money. This is a belt drive compressor that you can use on commonly used air tools. It gives you a perfect combination of features. It is heavy duty and compact, with wheels and a comfortable handle so it's easy to move around.

Model	Part Number	Configuration	l/min	Engine	Oil	Pump	L	HP	kW	Rpm	Voltz	Bar	Start type	dB(A)	LxWxH (mm)	KG	Dryer
PRO A29B 50 CM2.E1	4116024266	TM	255	Electric	ALTAIR PRO	A29B	50	2	1,5	1075	230/1/50	10	DOL	89,1	870 x 370 x 780	49	No
PRO A29B 50 CM3 MEC90	4116024268	TM	320	Electric	ALTAIR PRO	A29B	50	3	2,2	1300	230/1/50	10	DOL	89,1	940 x 410 x 800	49	No
PRO A29B 50 CT2.	4116024267	TM	255	Electric	ALTAIR PRO	A29B	50	2	1,5	1075	400/3/50	10	DOL	89,1	870 x 370 x 780	49	No



PRO A29B 90 LT - Pro Line

The ABAC PRO A29B 90 LT - Pro Line is ideal for use in small to medium sized garages and workshops. It comes with a regulator and gauge so it's simple to control accurately. The A29B system includes an aftercooler which cools the compressed air. This improves the durability of your equipment because moisture condenses out when the air temperature drops and this means the air will be drier when it runs through your air lines and air tools.

Model	Part Number	Configuration	l/min	Engine	Oil	Pump	L	HP	kW	Rpm	Voltz	Bar	Start type	dB(A)	LxWxH (mm)	KG	Dryer
PRO A29B 90 CM2.E1	4116024521	TM	255	Electric	ALTAIR PRO	A29B	90	2	1,5	1075	230/1/50	10	DOL	89,1	1010 x 415 x 900	56	No
PRO A29B 90 CT2	4116024522	TM	255	Electric	ALTAIR PRO	A29B	90	2	1,5	1075	400/3/50	10	DOL	89,1	1010 x 415 x 900	56	No
PRO A29B 90 FM2	4116024527	TM	255	Electric	ALTAIR PRO	A29B	90	2	1,5	1075	230/1/50	10	DOL	89,1	1010 x 415 x 900	56	No



PRO A29B 90 LT - Pro Line

The ABAC PRO A29B 90 LT - Pro Line is ideal for use in small to medium sized garages and workshops. It comes with a regulator and gauge so it's simple to control accurately. The A29B system includes an aftercooler which cools the compressed air. This improves the durability of your equipment because moisture condenses out when the air temperature drops and this means the air will be drier when it runs through your air lines and air tools.

Model	Part Number	Configuration	l/min	Engine	Oil	Pump	L	HP	kW	Rpm	Voltz	Bar	Start type	dB(A)	LxWxH (mm)	KG	Dryer
PRO A29B 90 FT2	4116024528	TM	255	Electric	ALTAIR PRO	A29B	90	2	1,5	1075	400/3/50	10	DOL	89,1	1010 x 415 x 900	56	No



PRO A29B 100 LT - Pro Line

With a standard aftercooler and slow speed pump that reduces operating temperature, the PRO A29B 100 LT - Pro Line is a user-friendly piston air compressor with great performance.

Model	Part Number	Configuration	l/min	Engine	Oil	Pump	L	HP	kW	Rpm	Voltz	Bar	Start type	dB(A)	LxWxH (mm)	KG	Dryer
PRO A29B 100 CM2.E1	4116024568	TM	255	Electric	ALTAIR PRO	A29B	100	2	1,5	1075	230/1/50	10	DOL	89,1	1010 x 415 x 900	56	No
PRO A29B 100 CT2	4116024569	TM	255	Electric	ALTAIR PRO	A29B	100	2	1,5	1075	400/3/50	10	DOL	89,1	1010 x 415 x 900	56	No



PRO A29B 150 LT - Pro Line

The ABAC PRO A29B 150 LT - Pro Line has a 150 litre tank to store compressed air and this lets you to run higher demand air tools. It gives you a perfect combination of features.

Model	Part Number	Configuration	l/min	Engine	Oil	Pump	L	HP	kW	Rpm	Voltz	Bar	Start type	dB(A)	LxWxH (mm)	KG	Dryer
PRO A29B 150 CM2 .	4116024536	TM	255	Electric	ALTAIR PRO	A29B	150	2	1,5	1075	230/1/50	10	DOL	89,1	1375 x 420 x 950	87	No
PRO A29B 150 CT2	4116024537	TM	255	Electric	ALTAIR PRO	A29B	150	2	1,5	1075	400/3/50	10	DOL	89,1	1375 x 420 x 950	87	No
PRO A29B 150 FM2	4116024546	TM	255	Electric	ALTAIR PRO	A29B	150	2	1,5	1075	230/1/50	10	DOL	89,1	1375 x 420 x 950	87	No
PRO A29B 150 FT2	4116024547	TM	255	Electric	ALTAIR PRO	A29B	150	2	1,5	1075	400/3/50	10	DOL	89,1	1375 x 420 x 950	87	No



A39B 90 LT - Pro Line

A great value belt drive compressor, which is both heavy duty and compact and ideal for powering all commonly used air tools. The A39B 90 LT, 3 HP stationary unit is three phase.

Model	Part Number	Configuration	l/min	Engine	Oil	Pump	L	HP	kW	Rpm	Voltz	Bar	Start type	dB(A)	LxWxH (mm)	KG	Dryer
PRO A39B 90 CM3 NZ	4116024865	TM	393	Electric	ALTAIR PRO	A39B	90	3	2,2	1050	230/1/50	10	DOL	89,1	1180 x 460 x 930	72	No
PRO A39B 90 CM3.E1	4116024523	TM	393	Electric	ALTAIR PRO	A39B	90	3	2,2	1050	230/1/50	10	DOL	89,1	1180 x 460 x 930	72	No
PRO A39B 90 CM4	4116025475	TM	486	Electric	ALTAIR PRO	A39B	90	4	3	1300	230/1/50	10	DOL	94,3	1180 x 460 x 930	72	No
PRO A39B 90 CT3 .	4116024524	TM	393	Electric	ALTAIR PRO	A39B	90	3	2,2	1050	400/3/50	10	DOL	89,1	1180 x 460 x 930	72	No
PRO A39B 90 CT4	4116024614	TM	486	Electric	ALTAIR PRO	A39B	90	4	3	1300	400/3/50	10	DOL	94,3	1180 x 460 x 930	72	No
PRO A39B 90 FM3 E1	4116024529	TM	393	Electric	ALTAIR PRO	A39B	90	3	2,2	1050	230/1/50	10	DOL	89,1	1180 x 460 x 930	72	No
PRO A39B 90 FT3	4116024530	TM	393	Electric	ALTAIR PRO	A39B	90	3	2,2	1050	400/3/50	10	DOL	89,1	1180 x 460 x 930	72	No



A39B 100 LT - Pro Line

With a standard aftercooler and slow speed pump that reduces operating temperature, the A39B 100 LT - Pro Line is a user-friendly piston air compressor with great performance.

Model	Part Number	Configuration	l/min	Engine	Oil	Pump	L	HP	kW	Rpm	Voltz	Bar	Start type	dB(A)	LxWxH (mm)	KG	Dryer
PRO A39B 100 CM3	4116024278	TM	393	Electric	ALTAIR PRO	A39B	100	3	2,2	1050	230/1/50	10	DOL	96	1180 x 460 x 930	72	No
PRO A39B 100 CM3 ISPM	4116024771	TM	393	Electric	ALTAIR PRO	A39B	100	3	2,2	1050	230/1/50	10	DOL	96	1180 x 460 x 930	72	No
PRO A39B 100 CT3	4116024279	TM	393	Electric	ALTAIR PRO	A39B	100	3	2,2	1050	400/3/50	10	DOL	96	1180 x 460 x 930	72	No



A39B 150 LT - Pro Line

With a standard aftercooler and slow speed pump that reduces operating temperature, the A39B 150 LT - Pro Line is a user-friendly piston air compressor with great performance.

Model	Part Number	Configuration	l/min	Engine	Oil	Pump	L	HP	kW	Rpm	Voltz	Bar	Start type	dB(A)	LxWxH (mm)	KG	Dryer
PRO A39B 150 CM3 ISPM	4116024773	TM	393	Electric	ALTAIR PRO	A39B	150	3	2,2	1050	230/1/50	10	DOL	89,1	1375 x 420 x 950	87	No
PRO A39B 150 CM3.E1	4116024280	TM	393	Electric	ALTAIR PRO	A39B	150	3	2,2	1050	230/1/50	10	DOL	89,1	1375 x 420 x 950	87	No
PRO A39B 150 CT3.	4116024281	TM	393	Electric	ALTAIR PRO	A39B	150	3	2,2	1050	400/3/50	10	DOL	89,1	1375 x 420 x 950	87	No
PRO A39B 150 FM3	4116024538	TM	393	Electric	ALTAIR PRO	A39B	150	3	2,2	1050	230/1/50	10	DOL	89,1	1375 x 420 x 950	87	No
PRO A39B 150 FT3	4116024539	TM	393	Electric	ALTAIR PRO	A39B	150	3	2,2	1050	400/3/50	10	DOL	89,1	1375 x 420 x 950	87	No
PRO A39B 150 VM3	4116024163	TM	393	Electric	ALTAIR PRO	A39B	150	3	2,2	1050	230/1/50	10	DOL	89,1	850 x 970 x 1950	160	No
PRO A39B 150 VT3	4116024162	TM	393	Electric	ALTAIR PRO	A39B	150	3	2,2	1050	400/3/50	10	DOL	89,1	850 x 970 x 1950	160	No



A39B 200 LT - Pro Line

A39B 200lt PRO LINE is a 3 HP static compressor mounted on a 200 litre receiver. It is the perfect choice for small workshops were three phase is available.

Model	Part Number	Configuration	l/min	Engine	Oil	Pump	L	HP	kW	Rpm	Voltz	Bar	Start type	dB(A)	LxWxH (mm)	KG	Dryer
PRO A39B 200 CM3 220/60 S/A	4116024174	TM	393	Electric	ALTAIR PRO	A39B	200	3	2,2	1050	220/3/60	10	DOL	89,1	1500 x 470 x 1110	120	No
PRO A39B 200 CM3.E1	4116024282	TM	393	Electric	ALTAIR PRO	A39B	200	3	2,2	1050	230/1/50	10	DOL	89,1	1500 x 470 x 1110	115	No
PRO A39B 200 CM4	4116025474	TM	486	Electric	ALTAIR PRO	A39B	200	4	3	1300	230/1/50	10	DOL	94,3	1500 x 470 x 1110	100	No
PRO A39B 200 CT3 .	4116024283	TM	393	Electric	ALTAIR PRO	A39B	200	3	2,2	1050	400/3/50	10	DOL	89,1	1500 x 470 x 1110	91	No
PRO A39B 200 CT4	4116024166	TM	486	Electric	ALTAIR PRO	A39B	200	4	3	1300	400/3/50	10	DOL	94,3	1500 x 470 x 1110	91	No
PRO A39B 200 FM3	4116024540	TM	393	Electric	ALTAIR PRO	A39B	200	3	2,2	1050	230/1/50	10	DOL	89,1	1500 x 450 x 1110	91	No
PRO A39B 200 FT3	4116024541	TM	393	Electric	ALTAIR PRO	A39B	200	3	2,2	1050	400/3/50	10	DOL	89,1	1500 x 450 x 1110	91	No
PRO A39B 200 FT4	4116024167	TM	486	Electric	ALTAIR PRO	A39B	200	4	3	1300	400/3/50	10	DOL	94,3	1500 x 450 x 1110	91	No

A39B 270 LT - Pro Line



A39B 270lt PRO LINE is a 3 HP static compressor mounted on a 270 litre receiver, suitable for a workshop where three phase is available. It is capable of running standard spray gun, tyre inflator, impact/ratchet wrenches or a low consumption shot blast cabinet. This unit is the perfect choice for small workshops.

Model	Part Number	Configuration	l/min	Engine	Oil	Pump	L	HP	kW	Rpm	Voltz	Bar	Start type	dB(A)	LxWxH (mm)	KG	Dryer
PRO A39B 270 CM3 230 60	4116025291	TM	393	Electric	ALTAIR PRO	A39B	270	3	2,2	1050	230/1/60	10	DOL	89,1	1530 x 595 x 1160	138	No
PRO A39B 270 CM3 ISPM	4116024772	TM	393	Electric	ALTAIR PRO	A39B	270	3	2,2	1050	230/1/50	10	DOL	89,1	1530 x 595 x 1160	138	No
PRO A39B 270 CM3.E1	4116024285	TM	393	Electric	ALTAIR PRO	A39B	270	3	2,2	1050	230/1/50	10	DOL	89,1	1530 x 595 x 1160	138	No
PRO A39B 270 CT3	4116024286	TM	393	Electric	ALTAIR PRO	A39B	270	3	2,2	1050	400/3/50	10	DOL	89,1	1530 x 595 x 1160	138	No
PRO A39B 270 CT4 ISPM	4116024774	TM	486	Electric	ALTAIR PRO	A39B	270	4	3	1300	400/3/50	10	DOL	94,3	1530 x 595 x 1160	138	No
PRO A39B 270 CT4.	4116024287	TM	486	Electric	ALTAIR PRO	A39B	270	4	3	1300	400/3/50	10	DOL	94,3	1530 x 595 x 1160	138	No
PRO A39B 270 FM3 .	4116024542	TM	393	Electric	ALTAIR PRO	A39B	270	3	2,2	1050	230/1/50	10	DOL	89,1	1532 x 456 x 1005	118	No
PRO A39B 270 FT3 .	4116024543	TM	393	Electric	ALTAIR PRO	A39B	270	3	2,2	1050	400/3/50	10	DOL	89,1	1530 x 595 x 1160	138	No
PRO A39B 270 FT4	4116024170	TM	486	Electric	ALTAIR PRO	A39B	270	4	3	1300	400/3/50	10	DOL	94,3	1530 x 595 x 1160	138	No



CA1 270 LT - Cast Iron

Piston compressors with fully cast iron blocks: a reliable and robust range, built with top quality components. The pumps are running at a low speed, to guarantee lower noise levels, lower operating temperatures and extended lifetimes, but they still guarantee a great performance, and they are perfectly suitable for the more demanding and intensive applications.

Model	Part Number	Configuration	l/min	Engine	Oil	Pump	L	HP	kW	Rpm	Voltz	Bar	Start type	dB(A)	LxWxH (mm)	KG	Dryer
PRO CA1 270 FT5,5	4116025181	TM	530	Electric	ALTAIR	CA1	270	5,5	4,1	688	400/3/50	11	DOL	91,1	1500 x 530 x 1210	214	No
PRO CA1 270 FT7,5	4116025182	TM	699	Electric	ALTAIR	CA1	270	7,5	5,6	908	400/3/50	11	DOL	93	1500 x 530 x 1210	239	No



CA1 500 LT - Cast Iron

Piston compressors with fully cast iron blocks: a reliable and robust range, built with top quality components. The pumps are running at a low speed, to guarantee lower noise levels, lower operating temperatures and extended lifetimes, but they guarantee a great performance, and perfectly suitable for the more demanding and intensive applications.

Model	Part Number	Configuration	l/min	Engine	Oil	Pump	L	HP	kW	Rpm	Voltz	Bar	Start type	dB(A)	LxWxH (mm)	KG	Dryer
PRO CA1 500 FT5,5	4116025186	TM	530	Electric	ALTAIR	CA1	500	5,5	4,1	688	400/3/50	11	DOL	91,1	1920 x 600 x 1340	303	No
PRO CA1 500 FT7,5	4116025183	TM	699	Electric	ALTAIR	CA1	500	7,5	5,6	908	400/3/50	11	DOL	93	1920 x 600 x 1340	328	No
PRO T CA1 500 FT7,5	4116025184	TM	1399	Electric	ALTAIR	CA1	500	7,5 +7,5	11	908	400/3/50	11	Y/D	98	1920 x 600 x 1340	488	No

Piston Compressors Belt Drive 2 Stage



Piston Compressors Belt Drive

2 Stage

A 2 Stage air compressor gives you a reliable supply of compressed air and reduces the stress on the system.

Pro Line

Ideal fit for medium and large workshops for those that need heavier duty and more frequent air. Wide selection and availability with full-feature, high-flow, high pressure and tandem options.

72

Cast Iron

Enjoy the impressive strength of cast iron material, with high cooling performance and the advantage of long service intervals.

88



A49B 0 LT - Pro Line

The ABAC A49B 0 LT - Pro Line has a small and compact design with a well known and proven technology.

Model	Part Number	Configuration	l/min	Engine	Oil	Pump	L	HP	kW	Rpm	Voltz	Bar	Start type	dB(A)	LxWxH (mm)	KG	Dryer
PRO A49B BF4	4116000256	BM	553	Electric	ALTAIR PRO	A49B	0	4	3	1300	400/3/50	11	DOL	94,7	738 x 430 x 563	54	No
PRO A49B BF5,5	4116000257	BM	595	Electric	ALTAIR PRO	A49B	0	5,5	4,1	1400	400/3/50	11	DOL	96,6	738 x 430 x 563	60	No



A49B 100 LT - Pro Line

The ABAC A49B 100 LT - Pro Line has been designed for professionals. Its exceptional characteristics of reliability, stability and sturdiness make it a product capable of satisfying the most varied needs of use.

Model	Part Number	Configuration	l/min	Engine	Oil	Pump	L	HP	kW	Rpm	Voltz	Bar	Start type	dB(A)	LxWxH (mm)	KG	Dryer
PRO A49B 100 CM3	4116000250	TM	444	Electric	ALTAIR PRO	A49B	100	3	2,2	1050	230/1/50	11	DOL	92	1006 x 486 x 927	70	No
PRO A49B 100 CT3	4116000232	TM	444	Electric	ALTAIR PRO	A49B	100	3	2,2	1050	400/3/50	11	DOL	93	1006 x 486 x 927	70	No



A49B 150 LT - Pro Line

The A49B 150 LT - Pro Line has been designed for professionals. Its exceptional characteristics of reliability, stability and sturdiness make it a product capable of satisfying the most varied needs of use.

Model	Part Number	Configuration	l/min	Engine	Oil	Pump	L	HP	kW	Rpm	Voltz	Bar	Start type	dB(A)	LxWxH (mm)	KG	Dryer
PRO A49B 150 CM3	4116000251	TM	444	Electric	ALTAIR PRO	A49B	150	3	2,2	1050	230/1/50	11	DOL	90,8	1305 x 501 x 1006	84	No
PRO A49B 150 CT3	4116000233	TM	444	Electric	ALTAIR PRO	A49B	150	3	2,2	1050	400/3/50	11	DOL	91,5	1305 x 501 x 1006	84	No

A49B 200 LT - Pro Line



The oil lubricated configuration of the A49B 200 LT - Pro Line, helps to reduce management costs and allow simple maintenance operations to be carried out quickly and easily.

Model	Part Number	Configuration	l/min	Engine	Oil	Pump	L	HP	kW	Rpm	Voltz	Bar	Start type	dB(A)	LxWxH (mm)	KG	Dryer
PRO A49B 200 CM3	4116000252	TM	444	Electric	ALTAIR PRO	A49B	200	3	2,2	1050	230/1/50	11	DOL	90,8	1437 x 573 x 1058	130	No
PRO A49B 200 CT3	4116000234	TM	444	Electric	ALTAIR PRO	A49B	200	3	2,2	1050	400/3/50	11	DOL	91,5	1437 x 573 x 1058	115	No
PRO A49B 200 CT4	4116000235	TM	553	Electric	ALTAIR PRO	A49B	200	4	3	1300	400/3/50	11	DOL	94,7	1437 x 573 x 1047	100	No
PRO A49B 200 CT5,5	4116000241	TM	595	Electric	ALTAIR PRO	A49B	200	5,5	4,1	1400	400/3/50	11	DOL	96,6	1437 x 573 x 1058	125	No
PRO A49B 200 FT4	4116000236	TM	553	Electric	ALTAIR PRO	A49B	200	4	3	1300	400/3/50	11	DOL	94,7	1532 x 456 x 1005	130	No
PRO A49B 200 FT5,5	4116000242	TM	595	Electric	ALTAIR PRO	A49B	200	5,5	4,1	1400	400/3/50	11	DOL	96,6	1532 x 456 x 1005	122	No
PRO A49B 200 VT4	4116000239	TM	553	Electric	ALTAIR PRO	A49B	200	4	3	1300	400/3/50	11	DOL	94,7	737 x 638 x 1679	110	No
PRO A49B 200 VT4 230/3/50	4116000309	TM	553	Electric	ALTAIR PRO	A49B	200	4	3	1300	230/3/50	11	DOL	94,7	737 x 638 x 1679	110	No
PRO A49B 200 VT5,5	4116000247	TM	595	Electric	ALTAIR PRO	A49B	200	5,5	4,1	1400	400/3/50	11	DOL	96,6	737 x 637 x 1679	117	No
PRO A49B 200 VT5,5 230/3/50	4116000308	TM	595	Electric	ALTAIR PRO	A49B	200	5,5	4,1	1400	230/3/50	11	DOL	96,6	737 x 637 x 1679	117	No

A49B 270 LT - Pro Line



The ABAC A49B 270 LT - Pro Line has been designed with strong heavy-duty components.

Its exceptional characteristics of reliability and stability make it a product capable of satisfying the most varied needs of use.

Model	Part Number	Configuration	l/min	Engine	Oil	Pump	L	HP	kW	Rpm	Voltz	Bar	Start type	dB(A)	LxWxH (mm)	KG	Dryer
PRO A49B 270 CM3	4116000297	TM	444	Electric	ALTAIR PRO	A49B	270	3	2,2	1050	230/1/50	11	DOL	90,8	1532 x 607 x 1128	120	No
PRO A49B 270 CM4	4116000254	TM	553	Electric	ALTAIR PRO	A49B	270	4	3	1300	230/1/50	11	DOL	91,5	1532 x 607 x 1128	120	No
PRO A49B 270 CT3	4116000298	TM	444	Electric	ALTAIR PRO	A49B	270	3	2,2	1050	400/3/50	11	DOL	91,5	1530 x 595 x 1160	138	No
PRO A49B 270 CT4	4116000237	TM	553	Electric	ALTAIR PRO	A49B	270	4	3	1300	400/3/50	11	DOL	94,7	1532 x 607 x 1128	138	No
PRO A49B 270 CT5,5	4116000243	TM	595	Electric	ALTAIR PRO	A49B	270	5,5	4,1	1400	400/3/50	11	DOL	96,6	1532 x 607 x 1132	124	No
PRO A49B 270 FM3	4116000253	TM	444	Electric	ALTAIR PRO	A49B	270	3	2,2	1050	230/1/50	11	DOL	90,8	1532 x 456 x 1005	118	No
PRO A49B 270 FT3	4116000249	TM	444	Electric	ALTAIR PRO	A49B	270	3	2,2	1050	400/3/50	11	DOL	91,5	1532 x 456 x 1005	118	No
PRO A49B 270 FT4	4116000238	TM	553	Electric	ALTAIR PRO	A49B	270	4	3	1300	400/3/50	11	DOL	94,7	1532 x 456 x 1005	120	No
PRO A49B 270 FT5,5	4116000244	TM	595	Electric	ALTAIR PRO	A49B	270	5,5	4,1	1400	400/3/50	11	DOL	96,6	1532 x 456 x 1005	124	No
PRO A49B 270 VT4	4116000240	TM	553	Electric	ALTAIR PRO	A49B	270	4	3	1300	400/3/50	11	DOL	94,7	737 x 600 x 1712	130	No
PRO A49B 270 VT5,5	4116000248	TM	595	Electric	ALTAIR PRO	A49B	270	5,5	4,1	1400	400/3/50	11	DOL	96,6	737 x 600 x 1712	138	No



A49B 500 LT - Pro Line

The ABAC A49B 500 LT - Pro Line piston air compressor has been designed for professionals. Its exceptional characteristics of reliability, stability and robustness make it a product capable of satisfying the most varied needs of use.

This compressor is ideal for frequent use.

Model	Part Number	Configuration	l/min	Engine	Oil	Pump	L	HP	kW	Rpm	Voltz	Bar	Start type	dB(A)	LxWxH (mm)	KG	Dryer
PRO A49B 500 CT5,5	4116000245	TM	595	Electric	ALTAIR PRO	A49B	500	5,5	4,1	1400	400/3/50	11	DOL	96,6	1951 x 680 x 1269	191	No
PRO A49B 500 FT5,5	4116000246	TM	595	Electric	ALTAIR PRO	A49B	500	5,5	4,1	1400	400/3/50	11	DOL	96,6	1950 x 530 x 1145	191	No



B5900B 90 LT - Pro Line

The B5900B 90 LT - Pro Line is a two stage belt drive compressor equipped with a 90 liters tank. Thanks to the oil injection it is possible to complete the required operations without excessive effort in addition to those due to routine maintenance.

Model	Part Number	Configuration	l/min	Engine	Oil	Pump	L	HP	kW	Rpm	Voltz	Bar	Start type	dB(A)	LxWxH (mm)	KG	Dryer
PRO B5900B 90 CT4 15B	4116025595	TM	653	Electric	ALTAIR PRO	B5900B	90	5,5	4,1	1400	400/3/50	15	DOL	95,4	2030 x 670 x 1400	97	No



B5900B 200 LT - Pro Line

This two stage belt drive compressor is a 5.5 HP static compressor mounted on a 200 litre receiver, suitable for a workshop where three phase is available. This compressor is the perfect choice for medium workshops.

Model	Part Number	Configuration	l/min	Engine	Oil	Pump	L	HP	kW	Rpm	Voltz	Bar	Start type	dB(A)	LxWxH (mm)	KG	Dryer
PRO B5900B 200 CT5.5	4116019696	TM	653	Electric	ALTAIR PRO	B5900B	200	5,5	4,1	1400	400/3/50	10	DOL	95,4	1580 x 580 x 1150	164	No
PRO B5900B 200 FT5.5	4116019700	TM	653	Electric	ALTAIR PRO	B5900B	200	5,5	4,1	1400	400/3/50	10	DOL	95,4	1580 x 580 x 1150	161	No
PRO B5900B 200 VT5.5	4116024563	TM	653	Electric	ALTAIR PRO	B5900B	200	5,5	4,1	1400	400/3/50	11	DOL	95,4	850 x 970 x 2050	205	No
PRO B6000 270 FT7.5 UK	4116020193	TM	653	Electric	ALTAIR PRO	B5900B	200	5,5	4,1	1400	400/3/50	10	DOL	95,4	1580 x 580 x 1150	161	No



B5900B 270 LT - Pro Line

The ABAC B5900B 270 LT - Pro Line is a piston air compressor designed for professional. With its strong handle with rubber grip it is a reliable and robustness product.

Model	Part Number	Configuration	l/min	Engine	Oil	Pump	L	HP	kW	Rpm	Voltz	Bar	Start type	dB(A)	LxWxH (mm)	KG	Dryer
PRO B5900B 270 CT5.5	4116019770	TM	653	Electric	ALTAIR PRO	B5900B	270	5,5	4,1	1400	400/3/50	10	DOL	95,4	1575 x 680 x 1150	170	No
PRO B5900B 270 FT5.5	4116019781	TM	653	Electric	ALTAIR PRO	B5900B	270	5,5	4,1	1400	400/3/50	10	DOL	95,4	1575 x 680 x 1150	167	No
PRO B5900B 270 FT5.5 220/60S/A	4116019778	TM	653	Electric	ALTAIR PRO	B5900B	270	5,5	4,1	1400	220/3/60	10	DOL	77	1575 x 680 x 1150	167	No
PRO B5900B 270 VT5.5	4116017006	TM	653	Electric	ALTAIR PRO	B5900B	270	5,5	4,1	1400	400/3/50	11	DOL	95,4	850 x 970 x 2100	210	No
PRO B5900B 270 VT5.5 V230	4116023694	TM	653	Electric	ALTAIR PRO	B5900B	270	5,5	4,1	1400	230/3/50	11	DOL	95,4	850 x 970 x 2100	210	No

B5900B 500 LT - Pro Line



The B5900B 500 LT - Pro Line piston air compressor guarantees extra comfort thanks to the lower speed allowing less noise and increasing lifetime of the product.

Model	Part Number	Configuration	l/min	Engine	Oil	Pump	L	HP	kW	Rpm	Voltz	Bar	Start type	dB(A)	LxWxH (mm)	KG	Dryer
PRO B5900B 500 CT5,5 V.380/60	4116023898	TM	653	Electric	ALTAIR PRO	B5900B	500	5,5	4,1	1400	380/3/60	10	DOL	95,4	2030 x 670 x 1400	222	No
PRO B5900B 500 CT5.5	4116019806	TM	653	Electric	ALTAIR PRO	B5900B	500	5,5	4,1	1400	400/3/50	10	DOL	95,4	2030 x 670 x 1400	222	No
PRO B5900B 500 FT5.5	4116019812	TM	653	Electric	ALTAIR PRO	B5900B	500	5,5	4,1	1400	400/3/50	10	DOL	95,4	2030 x 670 x 1400	219	No

B5900B 90 LT - Pro Line



The B5900B 90 LT - Pro Line is a two stage belt drive compressor equipped with a 90 liters tank. Thanks to the oil injection it is possible to complete the required operations without excessive effort in addition to those due to routine maintenance.

Model	Part Number	Configuration	l/min	Engine	Oil	Pump	L	HP	kW	Rpm	Voltz	Bar	Start type	dB(A)	LxWxH (mm)	KG	Dryer
B 5900B/90 CT5 5 DISG.15B ABAC	4116019685	TM	653	Electric	ALTAIR PRO	B5900B	90	5,5	4,1	1400	400/3/50	15	DOL	95,4	1100 x 500 x 950	97	No



B5900 100 LT - Pro Line

Designed for professionals, the B5900 100 LT - Pro Line is a reliable, stable and robust product, able to satisfy the most demanding needs.

Model	Part Number	Configuration	l/min	Engine	Oil	Pump	L	HP	kW	Rpm	Voltz	Bar	Start type	dB(A)	LxWxH (mm)	KG	Dryer
B 5900B/100 CT 5 5 V400 ITALIA	4116019676	TM	653	Electric	ALTAIR PRO	B5900	100	5,5	4,1	1400	400/3/50	10	DOL	95,4	1100 x 500 x 950	113	No



B5900 200 LT - Pro Line

The B5900 200 LT - Pro Line piston compressor has been designed for professionals and it is ideal for frequent use.

Model	Part Number	Configuration	l/min	Engine	Oil	Pump	L	HP	kW	Rpm	Voltz	Bar	Start type	dB(A)	LxWxH (mm)	KG	Dryer
B 5900B/200 CT 5 5 V400 CE	4116019723	TM	653	Electric	ALTAIR PRO	B5900	200	5,5	4,1	1400	400/3/50	10	DOL	95,4	1580 x 580 x 1150	132	No
B5900B 200 CT5.5 230/3/50	4116022573	TM	653	Electric	ALTAIR PRO	B5900	200	5,5	4,1	1400	230/3/50	10	DOL	95,4	1580 x 580 x 1150	143	No



B5900 270 LT - Pro Line

The B5900 270 LT - Pro Line is a two stage belt drive compressor equipped with a 270 liters tank and it is a reliable option thanks to its strong heavy-duty components.

Model	Part Number	Configuration	l/min	Engine	Oil	Pump	L	HP	kW	Rpm	Voltz	Bar	Start type	dB(A)	LxWxH (mm)	KG	Dryer
B 5900B/270 CT 5 5 V400 ABAC	4116019924	TM	653	Electric	ALTAIR PRO	B5900	270	5,5	4,1	1400	400/3/50	10	DOL	95,4	1575 x 680 x 1150	147	No
B 5900B/270 CT 5 5 V400 CE	4116019761	TM	570	Electric	ALTAIR PRO	B5900	270	5,5	4,1	1200	400/3/50	10	DOL	77	1575 x 680 x 1150	142,5	No
B5900B 270 CT5.5 230/3/50	4116023558	TM	570	Electric	ALTAIR PRO	B5900	270	5,5	4,1	1200	230/3/50	10	DOL	95,4	1575 x 680 x 1150	142,5	No
B5900B 270 CT5.5 ISPM	4116023091	TM	653	Electric	ALTAIR PRO	B5900	270	5,5	4,1	1400	400/3/50	10	DOL	95,4	1575 x 680 x 1150	142,5	No

B5900 500 LT - Pro Line



With a strong handle with rubber grip and pivoting locking wheel, the B5900 500 LT - Pro Line piston air compressor is a good option for who needs a safe and maneuverable product.

Model	Part Number	Configuration	l/min	Engine	Oil	Pump	L	HP	kW	Rpm	Voltz	Bar	Start type	dB(A)	LxWxH (mm)	KG	Dryer
B5900B 500 CT5.5 ISPM	4116019807	TM	653	Electric	ALTAIR PRO	B5900	500	5,5	4,1	1400	400/3/50	10	DOL	95,4	2030 x 670 x 1400	194	No
B5900B/500 CT5.5 V220/60 ME	4116019827	TM	525	Electric	ALTAIR PRO	B5900	500	5,5	4,1	1100	220/3/60	10	DOL	77	2030 x 670 x 1400	194	No

B5900B 500 LT - Pro Line



The B5900B 500 LT - Pro Line piston air compressor guarantees extra comfort thanks to the lower speed allowing less noise and increasing lifetime of the product.

Model	Part Number	Configuration	l/min	Engine	Oil	Pump	L	HP	kW	Rpm	Voltz	Bar	Start type	dB(A)	LxWxH (mm)	KG	Dryer
B5900B 500 FT5.5 220/60 S/A	4116022355	TM	525	Electric	ALTAIR PRO	B5900B	500	5,5	4,1	1100	220/3/60	11	DOL	95,4	2030 x 670 x 1400	191	No

B6000 270 LT - Pro Line



With strong heavy-duty components and a double stage high air volume pump, the B6000 270 LT - Pro Line is a reliable solution for professionals who need a reliable and robust product.

Model	Part Number	Configuration	l/min	Engine	Oil	Pump	L	HP	kW	Rpm	Voltz	Bar	Start type	dB(A)	LxWxH (mm)	KG	Dryer
PRO B6000 270 CT5.5	4116020179	TM	660	Electric	ALTAIR PRO	B6000	270	5,5	4,1	1100	400/3/50	10	DOL	95,4	1520 x 600 x 1250	171	No
PRO B6000 270 CT7.5	4116020182	TM	827	Electric	ALTAIR PRO	B6000	270	7,5	5,6	1400	400/3/50	10	DOL	82	1520 x 600 x 1250	180	No
PRO B6000 270 CT7.5 220/60 S/A	4116020177	TM	827	Electric	ALTAIR PRO	B6000	270	7,5	5,6	1400	220/3/60	10	DOL	82	1520 x 600 x 1250	180	No
PRO B6000 270 FT7,5 460/3/60	4116023893	TMD	827	Electric	ALTAIR PRO	B6000	270	7,5	5,6	1400	460/3/60	10	DOL	82	1520 x 600 x 1250	207	No
PRO B6000 270 FT7.5	4116020190	TMD	827	Electric	ALTAIR PRO	B6000	270	7,5	5,6	1400	400/3/50	10	DOL	82	1520 x 600 x 1250	207	No
PRO B6000 270 FT7.5 220/60 S/A	4116020186	TMD	827	Electric	ALTAIR PRO	B6000	270	7,5	5,6	1400	220/3/60	11	DOL	82	1520 x 600 x 1250	207	No
PRO B6000 270 FT7.5 ISPM	4116025459	TMD	827	Electric	ALTAIR PRO	B6000	270	7,5	5,6	1400	400/3/50	10	DOL	82	1520 x 600 x 1250	207	No
PRO B6000 270 VT7.5	4116017001	TMD	827	Electric	ALTAIR PRO	B6000	270	7,5	5,6	1400	400/3/50	11	DOL	82	850 x 970 x 2100	242	No



B6000 270 LT - Pro Line

With strong heavy-duty components and a double stage high air volume pump, the B6000 270 LT - Pro Line is a reliable solution for professionals who need a reliable and robust product.

Model	Part Number	Configuration	l/min	Engine	Oil	Pump	L	HP	kW	Rpm	Voltz	Bar	Start type	dB(A)	LxWxH (mm)	KG	Dryer
PRO B6000 270 VT7.5 15B	4116021231	TMD	827	Electric	ALTAIR PRO	B6000	270	7.5	5,6	1400	400/3/50	15	DOL	82	850 x 970 x 2100	242	No

B6000 500 LT - Pro Line



The B6000 500 LT - Pro Line is an easy to move piston air compressor with large pivot wheels with breaks and ensures extra comfort thanks to the lower speed that reduces noise.

Model	Part Number	Configuration	l/min	Engine	Oil	Pump	L	HP	kW	Rpm	Voltz	Bar	Start type	dB(A)	LxWxH (mm)	KG	Dryer
PRO B6000 500 CT5.5	4116020225	TM	660	Electric	ALTAIR PRO	B6000	500	5,5	4,1	1100	400/3/50	10	DOL	95,4	2030 x 670 x 1400	232	No
PRO B6000 500 CT7.5	4116020226	TM	827	Electric	ALTAIR PRO	B6000	500	7,5	5,6	1400	400/3/50	10	DOL	82	2030 x 670 x 1400	263	No
PRO B6000 500 CT7.5 220/60 ME	4116023865	TM	827	Electric	ALTAIR PRO	B6000	500	7,5	5,6	1400	220/3/60	10	DOL	82	2030 x 670 x 1400	263	No
PRO B6000 500 FT5.5	4116020242	TM	660	Electric	ALTAIR PRO	B6000	500	5,5	4,1	1100	400/3/50	11	DOL	95,4	2030 x 670 x 1400	229	No
PRO B6000 500 FT7.5	4116020243	TMD	827	Electric	ALTAIR PRO	B6000	500	7,5	5,6	1400	400/3/50	11	DOL	82	2030 x 670 x 1400	260	No
PRO B6000 500 FT7.5 15B YD	4116020249	TMD	827	Electric	ALTAIR PRO	B6000	500	7,5	5,6	1400	400/3/50	15	Y/D	82	2030 x 670 x 1400	290	No
PRO B6000 500 FT7.5 220/60 S/A	4116020240	TMD	827	Electric	ALTAIR PRO	B6000	500	7,5	5,6	1400	220/3/60	11	DOL	82	2030 x 670 x 1400	290	No
PRO B6000 500 FT7.5 LOW	4116023913	TMD	827	Electric	ALTAIR PRO	B6000	500	7,5	5,6	1400	400/3/50	11	DOL	82	2030 x 670 x 1400	290	No

B6000 0 LT - Pro Line



If you are looking for a small but powerful compressor that is tough enough for frequent use, our B6000 0 LT-Pro Line range is ideal for you.

These compressors are popular with OEMs because their small size makes them relatively easy to incorporate into your machinery, alongside a suitable receiver. They are also an excellent choice for your businesses if you are short of space.

Model	Part Number	Configuration	l/min	Engine	Oil	Pump	L	HP	kW	Rpm	Voltz	Bar	Start type	dB(A)	LxWxH (mm)	KG	Dryer
B6000 BS7.5 ISPM	4116000231	BM	827	Electric	ALTAIR PRO	B6000	0	7,5	5,6	1400	400/3/50	10	DOL	82	1100 x 590 x 800	120	No
B6000 BS7.5 T ISPM	4116000150	BM	827	Electric	ALTAIR PRO	B6000	0	7,5	5,6	1400	400/3/50	10	DOL	82	1100 x 590 x 800	120	No

B6000 200 LT - Pro Line



The B6000 200 LT - Pro Line has been designed for professional who need it for frequent use. With an oil lubricated configuration, in addition to reducing management costs, it allows to complete simple maintenance operations easily and quickly.

Model	Part Number	Configuration	l/min	Engine	Oil	Pump	L	HP	kW	Rpm	Voltz	Bar	Start type	dB(A)	LxWxH (mm)	KG	Dryer
B 6000/200 CT 7 5 V400	4116023667	TM	827	Electric	ALTAIR PRO	B6000	200	7,5	5,6	1400	400/3/50	10	DOL	82	1500 x 580 x 1290	174,5	No

B6000 270 LT - Pro Line



With strong heavy-duty components and a double stage high air volume pump, the B6000 270 LT - Pro Line is a reliable solution for professionals who need a reliable and robust product.

Model	Part Number	Configuration	l/min	Engine	Oil	Pump	L	HP	kW	Rpm	Voltz	Bar	Start type	dB(A)	LxWxH (mm)	KG	Dryer
B 6000/270 CT 5 5 400 CE ABAC	4116020421	TM	660	Electric	ALTAIR PRO	B6000	270	5,5	4,1	1100	400/3/50	10	DOL	95,4	1520 x 600 x 1250	150	No
B 6000/270 CT 7 5 V400 ABAC	4116020429	TM	827	Electric	ALTAIR PRO	B6000	270	7,5	5,6	1400	400/3/50	10	DOL	82	1520 x 600 x 1250	159	No
B 6000/270 CT 7 5 V400 CE ABAC	4116020435	TM	827	Electric	ALTAIR PRO	B6000	270	7,5	5,6	1400	400/3/50	10	DOL	82	1520 x 600 x 1250	159	No
B 6000/270 FT 7 5 V230/50	4116020504	TMD	827	Electric	ALTAIR PRO	B6000	270	7,5	5,6	1400	230/3/50	10	DOL	82	1520 x 600 x 1250	159	No
B 6000/270 FT 7 5 V400 CE	4116020484	TMD	827	Electric	ALTAIR PRO	B6000	270	7,5	5,6	1400	400/3/50	10	DOL	82	1520 x 600 x 1250	159	No

B6000 500 LT - Pro Line



The B6000 500 LT - Pro Line is an easy to move piston air compressor with large pivot wheels with breaks and ensures extra comfort thanks to the lower speed that reduces noise.

Model	Part Number	Configuration	l/min	Engine	Oil	Pump	L	HP	kW	Rpm	Voltz	Bar	Start type	dB(A)	LxWxH (mm)	KG	Dryer
B 6000/500 CT 7 5 V400 CE ABAC	4116020281	TM	827	Electric	ALTAIR PRO	B6000	500	7,5	5,6	1400	400/3/50	10	DOL	82	2030 x 670 x 1400	235	No
B 6000/500 FT7 5 V400 15B ABAC	4116020352	TMD	827	Electric	ALTAIR PRO	B6000	500	7,5	5,6	1400	400/3/50	15	DOL	82	2030 x 670 x 1400	232	No
B6000 500 CT7 5 ISPM	4116020227	TM	827	Electric	ALTAIR PRO	B6000	500	7,5	5,6	1400	400/3/50	10	DOL	82	2030 x 670 x 1400	235	No
B6000 500 CT7.5 380/60 CE	4116020294	TM	827	Electric	ALTAIR PRO	B6000	500	7,5	5,6	1400	220/3/60	11	DOL	82	2030 x 670 x 1400	235	No
B6000 500 FT7.5 400 ISPM	4116022402	TMD	827	Electric	ALTAIR PRO	B6000	500	7,5	5,6	1400	400/3/50	10	DOL	82	2030 x 670 x 1400	201	No



B6000 500 LT - Pro Line

The B6000 500 LT - Pro Line is an easy to move piston air compressor with large pivot wheels with breaks and ensures extra comfort thanks to the lower speed that reduces noise.

Model	Part Number	Configuration	l/min	Engine	Oil	Pump	L	HP	kW	Rpm	Voltz	Bar	Start type	dB(A)	LxWxH (mm)	KG	Dryer
B6000/500 CT5.5 V220/60 ME	4116020254	TM	660	Electric	ALTAIR PRO	B6000	500	5,5	4,1	1100	220/3/60	10	DOL	95,4	2030 x 670 x 1400	204	No
B6000/500 CT7,5 V400 CE ABAC	4116023977	TM	827	Electric	ALTAIR PRO	B6000	500	7,5	5,6	1400	400/3/50	11	DOL	82	2030 x 670 x 1400	235	No
B6000/500 CT7.5 V220/60 ME	4116020265	TM	827	Electric	ALTAIR PRO	B6000	500	7,5	5,6	1400	220/3/60	10	DOL	82	2030 x 670 x 1400	235	No



B7000 270 LT - Pro Line

If you need an air compressor for an industrial environment or large workshop, the ABAC B7000 270 LT - Pro Line range is an excellent starting point. When you choose a two stage belt drive compressor, you get a tough piece of equipment with a high duty cycle. This will give you a high enough capacity of compressed air for most large workshops and many industrial settings. The system is robust enough to cope with occasional periods of longer usage.

Model	Part Number	Configuration	l/min	Engine	Oil	Pump	L	HP	kW	Rpm	Voltz	Bar	Start type	dB(A)	LxWxH (mm)	KG	Dryer
PRO B7000 270 CT10	4116020782	TM	1210	Electric	ALTAIR PRO	B7000	270	10	7,5	1300	400/3/50	11	DOL	82	1520 x 600 x 1250	199	No
PRO B7000 270 CT7.5	4116020778	TM	1023	Electric	ALTAIR PRO	B7000	270	7,5	5,6	1100	400/3/50	11	DOL	82	1520 x 600 x 1250	194	No
PRO B7000 270 FT10	4116020790	TMD	1210	Electric	ALTAIR PRO	B7000	270	10	7,5	1300	400/3/50	11	DOL	82	1520 x 600 x 1250	196	No
PRO B7000 270 FT10 YD 2"	4116020794	TMD	1210	Electric	ALTAIR PRO	B7000	270	10	7,5	1300	400/3/50	11	Y/D	82	1520 x 600 x 1250	196	No
PRO B7000 270 FT7.5	4116020789	TMD	1023	Electric	ALTAIR PRO	B7000	270	7,5	5,6	1100	400/3/50	11	DOL	82	1520 x 600 x 1250	191	No
PRO B7000 270 VT10	4116017002	TMD	1210	Electric	ALTAIR PRO	B7000	270	10	7,5	1300	400/3/50	11	DOL	82	850 x 970 x 2100	261	No



B7000 500 LT - Pro Line

Do you need a high pressure air compressor for an industrial environment or large workshop? If you do, the ABAC B7000 500 LT - Pro Line range of compressors it's what you need. We fit all our high pressure air compressors with air receivers which are thick enough to cope with higher working pressures.

Model	Part Number	Configuration	l/min	Engine	Oil	Pump	L	HP	kW	Rpm	Voltz	Bar	Start type	dB(A)	LxWxH (mm)	KG	Dryer
PRO B7000 500 CT10	4116020835	TM	1210	Electric	ALTAIR PRO	B7000	500	10	7,5	1300	400/3/50	11	DOL	82	2030 x 670 x 1400	282	No
PRO B7000 500 CT10 220/3/50	4116023870	TM	1210	Electric	ALTAIR PRO	B7000	500	10	7,5	1300	220/3/50	11	DOL	82	2030 x 670 x 1400	282	No



B7000 500 LT - Pro Line

Do you need a high pressure air compressor for an industrial environment or large workshop? If you do, the ABAC B7000 500 LT - Pro Line range of compressors it's what you need. We fit all our high pressure air compressors with air receivers which are thick enough to cope with higher working pressures.

Model	Part Number	Configuration	l/min	Engine	Oil	Pump	L	HP	kW	Rpm	Voltz	Bar	Start type	dB(A)	LxWxH (mm)	KG	Dryer
PRO B7000 500 CT7.5	4116020834	TM	1023	Electric	ALTAIR PRO	B7000	500	75	5,6	1100	400/3/50	11	DOL	82	2030 x 670 x 1400	277	No
PRO B7000 500 FT10	4116020855	TMD	1210	Electric	ALTAIR PRO	B7000	500	10	7,5	1300	400/3/50	11	DOL	82	2030 x 670 x 1400	279	No
PRO B7000 500 FT10 15B	4116020864	TMD	1210	Electric	ALTAIR PRO	B7000	500	10	7,5	1300	400-700/3/50	15	DOL	82	2030 x 670 x 1400	305	No
PRO B7000 500 FT10 15B YD	4116020860	TMD	930	Electric	ALTAIR PRO	B7000	500	10	7,5	1300	400/3/50	15	Y/D	82	2030 x 670 x 1400	305	No
PRO B7000 500 FT10 15B YD 60ME	4116023738	TMD	1210	Electric	ALTAIR PRO	B7000	500	10	7,5	1300	400/3/50	15	Y/D	82	2030 x 670 x 1400	305	No
PRO B7000 500 FT10 220/60 S/A	4116020851	TMD	1130	Electric	ALTAIR PRO	B7000	500	10	7,5	1300	220/3/60	11	DOL	82	2030 x 670 x 1400	279	No
PRO B7000 500 FT7.5	4116020852	TMD	1023	Electric	ALTAIR PRO	B7000	500	75	5,6	1100	400/3/50	11	DOL	82	2030 x 670 x 1400	277	No

B7000 900 LT - Pro Line



With a big air receiver for bigger air volume, the B7000 900 LT - Pro Line piston air compressor ensures great performance and reliability.

Model	Part Number	Configuration	l/min	Engine	Oil	Pump	L	HP	kW	Rpm	Voltz	Bar	Start type	dB(A)	LxWxH (mm)	KG	Dryer
PRO B7000 900 FT10	4116020796	TMD	1210	Electric	ALTAIR PRO	B7000	900	10	7,5	1300	400/3/50	11	DOL	82	2070 x 800 x 1570	335	No

B7000 0 LT - Pro Line



If you need an air compressor for an industrial environment or large workshop, the ABAC B7000 0 LT - Pro Line range is an excellent starting point. When you choose a two stage belt drive compressor, you get a tough piece of equipment with a high duty cycle. This will give you a high enough capacity of compressed air for most large workshops and many industrial settings.

Model	Part Number	Configuration	l/min	Engine	Oil	Pump	L	HP	kW	Rpm	Voltz	Bar	Start type	dB(A)	LxWxH (mm)	KG	Dryer
B7000 BF10 400/700 15B YD	4116000170	BM	1210	Electric	ALTAIR PRO	B7000	0	10	7,5	1300	400-700/3/50	15	Y/D	82	1100 x 590 x 800	119	No
B7000 BF7.5 230/400 60HZ	4116000010	BM	1023	Electric	ALTAIR PRO	B7000	0	7,5	5,6	1100	400-700/3/50	10	DOL	82	1100 x 590 x 800	114	No
B7000 BS10 400/700 ISPM	4116000151	BM	1210	Electric	ALTAIR PRO	B7000	0	10	7,5	1300	400-700/3/50	10	DOL	82	1100 x 590 x 800	135	No



B7000 270 LT - Pro Line

If you need an air compressor for an industrial environment or large workshop, the ABAC B7000 270 LT - Pro Line range is an excellent starting point. When you choose a two stage belt drive compressor, you get a tough piece of equipment with a high duty cycle. This will give you a high enough capacity of compressed air for most large workshops and many industrial settings. The system is robust enough to cope with occasional periods of longer usage.

Model	Part Number	Configuration	l/min	Engine	Oil	Pump	L	HP	kW	Rpm	Voltz	Bar	Start type	dB(A)	LxWxH (mm)	KG	Dryer
B 7000/270 CT 7 5 V400 ABAC	4116021016	TM	2046	Electric	ALTAIR PRO	B7000	270	7,5 + 7,5	11	1100	400/3/50	10	Y/D	82	1670 x 555 x 1155	199	No
B 7000/270 FT 10 V400 S/T	4116021031	TMD	1210	Electric	ALTAIR PRO	B7000	270	10	7,5	1300	400/3/50	10	DOL	82	1520 x 600 x 1250	175	No
B 7000/270 FT10 V230/400 ST	4116023699	TMD	1210	Electric	ALTAIR PRO	B7000	270	10	7,5	1300	400/3/50	10	DOL	82	1520 x 600 x 1250	175	No



B7000 500 LT - Pro Line

Do you need a high pressure air compressor for an industrial environment or large workshop? If you do, the ABAC B7000 500 LT - Pro Line range of compressors it's what you need. We fit all our high pressure air compressors with air receivers which are thick enough to cope with higher working pressures.

Model	Part Number	Configuration	l/min	Engine	Oil	Pump	L	HP	kW	Rpm	Voltz	Bar	Start type	dB(A)	LxWxH (mm)	KG	Dryer
B 7000/500 CT 10 V400 CE ABAC	4116020872	TM	1210	Electric	ALTAIR PRO	B7000	500	10	7,5	1300	400/3/50	10	DOL	82	2030 x 670 x 1400	254	No
B 7000/500 FT 10 V230/50	4116020976	TMD	1210	Electric	ALTAIR PRO	B7000	500	10	7,5	1300	230/3/50	10	DOL	82	2030 x 670 x 1400	251	No
B 7000/500 FT 10 V400 CE	4116020843	TMD	1210	Electric	ALTAIR PRO	B7000	500	10	7,5	1300	400/3/50	10	DOL	82	2030 x 670 x 1400	251	No
B 7000/500 FT 10 V400 CE	4116020943	TMD	1210	Electric	ALTAIR PRO	B7000	500	10	7,5	1300	400/3/50	10	DOL	82	2030 x 670 x 1400	251	No
B7000 500 FT10 ISPM	4116020856	TMD	1210	Electric	ALTAIR PRO	B7000	500	10	7,5	1300	400/3/50	10	DOL	82	2030 x 670 x 1400	251	No
B7000 500 FT10 230/3/50 YD 15B	4116023682	TMD	1210	Electric	ALTAIR PRO	B7000	500	10	7,5	1300	230/3/50	15	Y/D	82	2030 x 670 x 1400	295	No
B7000/500 CT10 V220/60 ME	4116020875	TM	1130	Electric	ALTAIR PRO	B7000	500	10	7,5	1300	220/3/60	10	DOL	82	2030 x 670 x 1400	254	No
B7000/500 CT7.5 V220/60 ME	4116022277	TM	1023	Electric	ALTAIR PRO	B7000	500	7,5	5,6	1100	220/3/60	10	DOL	82	2030 x 670 x 1400	251	No



B7900 270 LT - Pro Line

The B7900 270 LT - Pro Line belt driven piston air compressor ensures comfort and it is a space saving solution.

Model	Part Number	Configuration	l/min	Engine	Oil	Pump	L	HP	kW	Rpm	Voltz	Bar	Start type	dB(A)	LxWxH (mm)	KG	Dryer
PRO B7900-270 FT10 YD	4116023868	TMD	784	Electric	ALTAIR	B7900	270	10	7.5	622	400/3/50	10	Y/D	71	1050 x 700 x 1950	243	No



B7900 500 LT - Pro Line

With a strong pump running at lower speed, the B7900 500 LT - Pro Line ensures extra comfort to the operations and a long lifetime of the product.

Model	Part Number	Configuration	l/min	Engine	Oil	Pump	L	HP	kW	Rpm	Voltz	Bar	Start type	dB(A)	LxWxH (mm)	KG	Dryer
B 7900S/500 FT 15 V400 CE ABAC	4116020151	TM	784	Electric	ALTAIR	B7900	500	15	11.2	622	400/3/50	10	Y/D	82	2030 x 680 x 1400	297	No
PRO B7900 500 FT10	4116023545	TMD	784	Electric	ALTAIR	B7900	500	10	7.5	622	400/3/50	11	DOL	82	2030 x 680 x 1400	295	No
PRO B7900 500 FT10 YD	4116020063	TMD	784	Electric	ALTAIR	B7900	500	10	7.5	622	400/3/50	10	Y/D	82	2030 x 680 x 1400	295	No
PRO B7900 500 FT15 220/60 S/A	4116020021	TM	784	Electric	ALTAIR	B7900	500	15	11.2	622	220/3/60	11	Y/D	82	2030 x 680 x 1400	295	No



B5900B 500 LT - Tandem

Our PRO tandem units are fitted with two double stage pump units delivering high outputs. As everything gets larger and heavier we have mounted these units on heavy duty air receivers and given them a large 500 litre storage volume to ensure correct operation. Metal guards and star delta starter assembly complete this heavy duty compressor designed for more demanding operations.

Model	Part Number	Configuration	l/min	Engine	Oil	Pump	L	HP	kW	Rpm	Voltz	Bar	Start type	dB(A)	LxWxH (mm)	KG	Dryer
PRO B5900 500 T5.5	4116019884	TM	1306	Electric	ALTAIR PRO	B5900B	500	5.5+5.5	8	1400	400/3/50	10	Y/D	95,4	2030 x 670 x 1400	323	No



B5900 500 LT - Tandem

With strong components, the B5900 500 LT - Tandem is a durable piston air compressor with proven and reliable technology that ensure performance and flexibility.

Model	Part Number	Configuration	l/min	Engine	Oil	Pump	L	HP	kW	Rpm	Voltz	Bar	Start type	dB(A)	LxWxH (mm)	KG	Dryer
B 5900B/500 T 5 5 V400 CE ABAC	4116019908	TM	1140	Electric	ALTAIR PRO	B5900	500	5,5 + 5,5	8	1200	400/3/50	10	Y/D	77	2020 x 1000 x 1600	306	No
B5900B/500 T5.5 V220/60 ME	4116019886	TM	1306	Electric	ALTAIR PRO	B5900	500	5,5 + 5,5	8	1400	220/3/60	10	Y/D	77	2020 x 1000 x 1600	306	No

B6000 500 LT - Tandem



Our PRO tandem units are fitted with our two double stage pump units delivering high outputs. As everything gets larger and heavier we have mounted these units on heavy duty air receivers and given them a large 500 litre storage volume to ensure correct operation. Metal guards and star delta starter assembly complete this heavy duty compressor designed for more demanding operations.

Model	Part Number	Configuration	l/min	Engine	Oil	Pump	L	HP	kW	Rpm	Voltz	Bar	Start type	dB(A)	LxWxH (mm)	KG	Dryer
PRO B6000 500 T5.5	4116020371	TM	1320	Electric	ALTAIR PRO	B6000	500	5,5 + 5,5	8	1100	400/3/50	11	Y/D	82	2030 x 670 x 1400	325	No
PRO B6000 500 T7.5	4116020375	TM	1654	Electric	ALTAIR PRO	B6000	500	7,5 + 7,5	11	1400	400/3/50	11	Y/D	82	2030 x 670 x 1400	387	No
B 6000/500 T 7 5 V400 CE	4116020368	TM	1654	Electric	ALTAIR PRO	B6000	500	7,5 + 7,5	11	1400	400/3/50	10	Y/D	82	1894 x 600 x 1280	290	No
B 6000/500 T 7 5 V400 CE ABAC	4116020408	TM	1654	Electric	ALTAIR PRO	B6000	500	7,5 + 7,5	11	1400	400/3/50	10	Y/D	82	1894 x 600 x 1280	290	No
B6000/500 T7.5 220/60 ME	4116020381	TM	1654	Electric	ALTAIR PRO	B6000	500	7,5 + 7,5	11	1400	220/3/60	10	Y/D	82	1894 x 600 x 1280	290	No

B7000 500 LT - Tandem



The B7000 500 LT - Tandem comes with two pump units for more flexibility and a proven and reliable technology that ensures great performance.

Model	Part Number	Configuration	l/min	Engine	Oil	Pump	L	HP	kW	Rpm	Voltz	Bar	Start type	dB(A)	LxWxH (mm)	KG	Dryer
PRO B7000 500 T7.5	4116020987	TM	2046	Electric	ALTAIR PRO	B7000	500	7,5 + 7,5	11	1100	400/3/50	11	Y/D	82	2030 x 670 x 1400	425	No
B 7000/500 T HP10 V220/60 ABAC	4116022324	TM	2260	Electric	ALTAIR PRO	B7000	500	10 + 10	15	900	220/3/60	10	Y/D	82	2030 x 680 x 1400	295	No

B7000 900 LT - Tandem



If you need an air compressor for an industrial environment or large workshop, the ABAC B7000 900 LT - Tandem range is an excellent starting point. When you choose a two stage belt drive compressor, you get a tough piece of equipment with a high duty cycle. This will give you a high enough capacity of compressed air for most large workshops and many industrial settings.

Model	Part Number	Configuration	l/min	Engine	Oil	Pump	L	HP	kW	Rpm	Voltz	Bar	Start type	dB(A)	LxWxH (mm)	KG	Dryer
PRO B7000 900 T10	4116020810	TM	2420	Electric	ALTAIR PRO	B7000	900	10 + 10	15	1400	400/3/50	11	Y/D	82	2070 x 800 x 1570	538	No
PRO B7000 900 T10 460/60/3	4116025485	TM	2260	Electric	ALTAIR PRO	B7000	900	10 + 10	15	900	460/3/60	11	Y/D	82	2070 x 800 x 1570	536	No
PRO B7000 900 T10 ISPM	4116020812	TM	2420	Electric	ALTAIR PRO	B7000	900	10 + 10	15	1400	400/3/50	10	Y/D	82	2070 x 800 x 1570	538	No
B 7000/900 T 10 V400 CE	4116020821	TM	2420	Electric	ALTAIR PRO	B7000	900	10 + 10	15	1400	400/3/50	10	Y/D	82	2070 x 800 x 1570	536	No
B 7000/900 T 10 V400 CE ABAC	4116020816	TM	2420	Electric	ALTAIR PRO	B7000	900	10 + 10	15	1400	400/3/50	10	Y/D	82	2070 x 800 x 1570	536	No

B7000 1000 LT - Tandem



The B7000 1000 LT - Tandem air compressor is an excellent air compressor for industrial environment and large workshop.

Model	Part Number	Configuration	l/min	Engine	Oil	Pump	L	HP	kW	Rpm	Voltz	Bar	Start type	dB(A)	LxWxH (mm)	KG	Dryer
B7000 1000 T10	4116021014	TM	2420	Electric	ALTAIR PRO	B7000	1000	10 + 10	15	1400	400/3/50	11	Y/D	82	2700 x 1650 x 805	497	No
B7000/1000 T10 220/60 ME	4116020819	TMD	2260	Electric	ALTAIR PRO	B7000	1000	10 + 10	15	900	220/3/60	10	Y/D	82	2700 x 1650 x 805	497	No

B6000 1000 LT - Tandem



The B6000 1000 LT - Tandem air compressor units are ideal for those users who are looking for high volume output from a compact footprint.

Model	Part Number	Configuration	l/min	Engine	Oil	Pump	L	HP	kW	Rpm	Voltz	Bar	Start type	dB(A)	LxWxH (mm)	KG	Dryer
B 6000/1000 T 7 5 V400 CE ABAC	4116020417	TM	1654	Electric	ALTAIR PRO	B6000	1000	7.5 + 7.5	11	1400	400/3/50	10	Y/D	82	2700 x 1650 x 805	459	No



B5900B 270 LT - Full Feature

This two stage belt drive compressor is a 5.5 HP static compressor mounted on a 270 litre receiver, suitable for a workshop where three phase is available. This compressor is the perfect choice for medium workshops. With the addition of a refrigerant air dryer it becomes a complete air station producing dry compressed air providing better quality air for air tools and paint spraying.

Model	Part Number	Configuration	l/min	Engine	Oil	Pump	L	HP	kW	Rpm	Voltz	Bar	Start type	dB(A)	LxWxH (mm)	KG	Dryer
B5900B 270 FT5.5 FFO	4116000159	TMD	653	Electric	ALTAIR PRO	B5900B	270	5,5	4,1	1400	400/3/50	11	DOL	95,4	1575 x 680 x 1150	197	Yes
B5900B 270 FT5.5 FFO YD	4116000171	TMD	653	Electric	ALTAIR PRO	B5900B	270	5,5	4,1	1400	400/3/50	11	Y/D	95,4	1575 x 680 x 1150	197	Yes



B6000 270 LT - Full Feature

B6000 270 LT - Full Feature is a two stage belt drive compressor, suitable for a workshop where three phase is available. This compressor is the perfect choice for medium workshops. With the addition of a refrigerant air dryer it becomes a complete air station producing dry compressed air providing better quality air for air tools and paint spraying.

Model	Part Number	Configuration	l/min	Engine	Oil	Pump	L	HP	kW	Rpm	Voltz	Bar	Start type	dB(A)	LxWxH (mm)	KG	Dryer
B6000 270 FT7.5 FFO	4116000166	TMD	827	Electric	ALTAIR PRO	B6000	270	7,5	5,6	1400	400/3/50	11	DOL	82	1520 x 600 x 1250	207	Yes
B6000 270 FT7.5 FFO YD	4116000173	TMD	827	Electric	ALTAIR PRO	B6000	270	7,5	5,6	1400	400/3/50	11	Y/D	82	1520 x 600 x 1250	207	Yes



B7000 270 LT - Full Feature

This two stage belt drive compressor is a 10 HP static compressor mounted on a 270 litre receiver, suitable for a workshop where three phase is available. This compressor is the perfect choice for medium workshops. With the addition of a refrigerant air dryer it becomes a complete air station producing dry compressed air providing better quality air for air tools and paint spraying.

Model	Part Number	Configuration	l/min	Engine	Oil	Pump	L	HP	kW	Rpm	Voltz	Bar	Start type	dB(A)	LxWxH (mm)	KG	Dryer
B7000 270 FT10 FFO	4116000168	TMD	1210	Electric	ALTAIR PRO	B7000	270	10	7,5	1300	400/3/50	11	DOL	82	1490 x 500 x 1175	231	Yes
B7000 270 FT10 FFO YD	4116000175	TMD	1210	Electric	ALTAIR PRO	B7000	270	10	7,5	1300	400/3/50	11	Y/D	82	1490 x 500 x 1175	231	Yes



B5900B 500 LT - Full Feature

The B5900B 500 LT - Full Feature is a 5.5 HP two stage belt drive static compressor mounted on a 500 litre receiver, suitable for a workshop where three phase is available. This compressor is the perfect choice for medium workshops. With the addition of a refrigerant air dryer it becomes a complete air station producing dry compressed air providing better quality air for air tools and paint spraying.

Model	Part Number	Configuration	l/min	Engine	Oil	Pump	L	HP	kW	Rpm	Voltz	Bar	Start type	dB(A)	LxWxH (mm)	KG	Dryer
B5900B 500 FT5.5 FFO	4116000165	TMD	653	Electric	ALTAIR PRO	B5900B	500	5,5	4,1	1400	400/3/50	11	DOL	95,4	2030 x 670 x 1400	249	Yes
B5900B 500 FT5.5 FFO YD	4116000172	TMD	653	Electric	ALTAIR PRO	B5900B	500	5,5	4,1	1400	400/3/50	11	Y/D	95,4	2030 x 670 x 1400	249	Yes



B6000 500 LT - Full Feature

This two stage belt drive compressor is a 7.5 HP static compressor mounted on a 500 litre receiver, suitable for a workshop where three phase is available. This compressor is the perfect choice for medium workshops. With the addition of a refrigerant air dryer it becomes a complete air station producing dry compressed air providing better quality air for air tools and paint spraying.

Model	Part Number	Configuration	l/min	Engine	Oil	Pump	L	HP	kW	Rpm	Voltz	Bar	Start type	dB(A)	LxWxH (mm)	KG	Dryer
B6000 500 FT7.5 FFO	4116000167	TMD	827	Electric	ALTAIR PRO	B6000	500	7,5	5,6	1400	400/3/50	11	DOL	82	2030 x 670 x 1400	290	Yes
B6000 500 FT7.5 FFO YD	4116000174	TMD	827	Electric	ALTAIR PRO	B6000	500	7,5	5,6	1400	400/3/50	11	Y/D	82	2030 x 670 x 1400	290	Yes



B7000 500 LT - Full Feature

The two stage belt drive compressor B7000 500 LT - Full Feature, is a 10 HP static compressor mounted on a 500 litre receiver, suitable for a workshop where three phase is available. This compressor is the perfect choice for medium workshops. With the addition of a refrigerant air dryer it becomes a complete air station producing dry compressed air providing better quality air for air tools and paint spraying.

Model	Part Number	Configuration	l/min	Engine	Oil	Pump	L	HP	kW	Rpm	Voltz	Bar	Start type	dB(A)	LxWxH (mm)	KG	Dryer
B7000 500 FT10 FFO	4116000169	TMD	1210	Electric	ALTAIR PRO	B7000	500	10	7,5	1300	400/3/50	11	DOL	82	2030 x 670 x 1400	314	Yes
B7000 500 FT10 FFO YD	4116000176	TMD	1210	Electric	ALTAIR PRO	B7000	500	10	7,5	1300	400/3/50	11	Y/D	82	2030 x 670 x 1400	314	Yes



CA2 270 LT - Cast Iron

The CA2 270 LT - Cast Iron comes with robust and high quality components that ensure reliability and comfort of usage.

Model	Part Number	Configuration	l/min	Engine	Oil	Pump	L	HP	kW	Rpm	Voltz	Bar	Start type	dB(A)	LxWxH (mm)	KG	Dryer
PRO CA2 270 FT10 YD	4116025246	TM	1056	Electric	ALTAIR	CA2	270	10	75	685	400/3/50	11	Y/D	94	1500 x 530 x 1210	269	No



CA2 500 LT - Cast Iron

Piston compressors with fully cast iron blocks: a reliable and robust range, built with top quality components. The pumps are running at a low speed, to guarantee lower noise levels, lower operating temperatures and extended lifetimes, but they still guarantee a great performance, and they are perfectly suitable for the more demanding and intensive applications.

Model	Part Number	Configuration	l/min	Engine	Oil	Pump	L	HP	kW	Rpm	Voltz	Bar	Start type	dB(A)	LxWxH (mm)	KG	Dryer
PRO CA2 500 FT10 .	4116025185	TM	1056	Electric	ALTAIR	CA2	500	10	75	685	400/3/50	11	DOL	94	1920 x 600 x 1340	358	No
PRO CA2 500 FT10 YD	4116025190	TM	1056	Electric	ALTAIR	CA2	500	10	75	685	400/3/50	11	Y/D	94	1920 x 600 x 1340	368	No

Piston Compressors Silent



500 LT - 5.5 HP
LN SILENT 

Lt.500

 **ABAC**
AIR COMPRESSORS
www.abacaircompressors.com



BOOST YOUR AIR

00010001



Piston Compressors Silent

Lower the noise. Choose well-being, while keeping the performance always on top.

Silent

Hear the sound of silence! A combination of precision machining, effective lubrication and external noise insulation to reduce some of the sound that might be produced. Ideal to use for your needs in enclosed spaces.

92



A29B 90 LT - Silent

Our silenced A29B range comes with an acoustic hood over the pump unit to provide noise reduction. With a lift and tilt mechanism ensuring good service access. This portable unit has a 90 litre air receiver with large wheels and locking castors.

Model	Part Number	Configuration	l/min	Engine	Oil	Pump	L	HP	kW	Rpm	Voltz	Bar	Start type	dB(A)	LxWxH (mm)	KG	Dryer
S A29B 90 CM2 E1	4116007346	TM	255	Electric	ALTAIR PRO	A29B	90	2	1,5	1075	230/1/50	10	DOL	69	1010 x 415 x 900	59	No
S A29B 90 CT2	4116007347	TM	255	Electric	ALTAIR PRO	A29B	90	2	1,5	1075	400/3/50	10	DOL	69	1010 x 415 x 900	59	No
S A29B 90 FM2	4116007358	TM	255	Electric	ALTAIR PRO	A29B	90	2	1,5	1075	230/1/50	10	DOL	69	1010 x 415 x 900	59	No
S A29B 90 FT2	4116007359	TM	255	Electric	ALTAIR PRO	A29B	90	2	1,5	1075	400/3/50	10	DOL	69	1010 x 415 x 900	59	No



A39B 90 LT - Silent

The A39B 90 LT - Silent is an easy to move piston air compressor that comes with an acoustic hood over the pump unit to provide noise reduction.

Model	Part Number	Configuration	l/min	Engine	Oil	Pump	L	HP	kW	Rpm	Voltz	Bar	Start type	dB(A)	LxWxH (mm)	KG	Dryer
S A39B 90 CM3	4116007392	TM	393	Electric	ALTAIR PRO	A39B	90	3	2,2	1050	230/1/50	10	DOL	74	1010 x 415 x 980	59	No

A29B 150 LT - Silent



The A29B 150 LT - Silent is a 2HP belt drive compressor that you can use on commonly used air tools. It gives you a perfect combination of features and it is ideal to use in small to medium sized garages and workshops.

Model	Part Number	Configuration	l/min	Engine	Oil	Pump	L	HP	kW	Rpm	Voltz	Bar	Start type	dB(A)	LxWxH (mm)	KG	Dryer
S A29B 150 CM2	4116007348	TM	255	Electric	ALTAIR PRO	A29B	150	2	1,5	1075	230/1/50	10	DOL	69	1375 x 420 x 950	87	No
S A29B 150 CT2	4116007349	TM	255	Electric	ALTAIR PRO	A29B	150	2	1,5	1075	400/3/50	10	DOL	69	1375 x 420 x 950	87	No
S A29B 150 FM2	4116007360	TM	255	Electric	ALTAIR PRO	A29B	150	2	1,5	1075	230/1/50	10	DOL	69	1375 x 420 x 950	90	No
S A29B 150 FT2	4116007361	TM	255	Electric	ALTAIR PRO	A29B	150	2	1,5	1075	400/3/50	10	DOL	69	1375 x 420 x 950	87	No

A39B 150 LT - Silent



Our silenced A39B 150 LT - Silent range comes with an acoustic hood over the pump unit to provide noise reduction. When you need to access the pump to service it, you simply use the lift and tilt mechanism.

Model	Part Number	Configuration	l/min	Engine	Oil	Pump	L	HP	kW	Rpm	Voltz	Bar	Start type	dB(A)	LxWxH (mm)	KG	Dryer
S A39B 150 CM3	4116007350	TM	393	Electric	ALTAIR PRO	A39B	150	3	2,2	1050	230/1/50	10	DOL	71	1375 x 420 x 1030	90	No
S A39B 150 CT3	4116007351	TM	393	Electric	ALTAIR PRO	A39B	150	3	2,2	1050	400/3/50	10	DOL	71	1375 x 420 x 1030	90	No
S A39B 150 FM3 UK	4116007362	TM	393	Electric	ALTAIR PRO	A39B	150	3	2,2	1050	230/1/50	10	DOL	71	1375 x 420 x 950	87	No
S A39B 150 FT3	4116007363	TM	393	Electric	ALTAIR PRO	A39B	150	3	2,2	1050	400/3/50	10	DOL	71	1375 x 420 x 950	87	No
S A39B 150 VM3	4116007377	TM	393	Electric	ALTAIR PRO	A39B	150	3	2,2	1050	400/3/50	10	DOL	71	850 x 970 x 1950	120	No
S A39B 150 VT3	4116007378	TM	393	Electric	ALTAIR PRO	A39B	150	3	2,2	1050	230/1/50	10	DOL	71	850 x 970 x 1950	120	No

A39B 200 LT - Silent



Our silenced A39B range comes with an acoustic hood over the pump unit to provide noise reduction. This is a 3 HP belt drive compressor that you can use on commonly used air tools. It gives you a perfect combination of features.

Model	Part Number	Configuration	l/min	Engine	Oil	Pump	L	HP	kW	Rpm	Voltz	Bar	Start type	dB(A)	LxWxH (mm)	KG	Dryer
S A39B 200 CM3	4116007352	TM	393	Electric	ALTAIR PRO	A39B	200	3	2,2	1050	230/1/50	10	DOL	71	1500 x 470 x 1190	94	No
S A39B 200 CT3	4116007353	TM	393	Electric	ALTAIR PRO	A39B	200	3	2,2	1050	400/3/50	10	DOL	71	1500 x 470 x 1190	94	No
S A39B 200 CT4	4116007356	TM	486	Electric	ALTAIR PRO	A39B	200	4	3	1300	400/3/50	10	DOL	74	1500 x 470 x 1190	94	No
S A39B 200 FM3 UK	4116007364	TM	393	Electric	ALTAIR PRO	A39B	200	3	2,2	1050	230/1/50	10	DOL	71	1500 x 470 x 1110	91	No
S A39B 200 FT3	4116007365	TM	393	Electric	ALTAIR PRO	A39B	200	3	2,2	1050	400/3/50	10	DOL	71	1500 x 470 x 1110	91	No
S A39B 200 FT4	4116007368	TM	486	Electric	ALTAIR PRO	A39B	200	4	3	1300	400/3/50	10	DOL	74	1500 x 470 x 1110	91	No



A39B 270 LT - Silent

With a double stage high air volume pump, the A39B 270 LT - Silent is a reliable product that ensures great performance.

Model	Part Number	Configuration	l/min	Engine	Oil	Pump	L	HP	kW	Rpm	Voltz	Bar	Start type	dB(A)	LxWxH (mm)	KG	Dryer
S A39B 270 CM3	4116007354	TM	393	Electric	ALTAIR PRO	A39B	270	3	2,2	1050	230/1/50	10	DOL	74	1530 x 595 x 1140	141	No
S A39B 270 CT3	4116007355	TM	393	Electric	ALTAIR PRO	A39B	270	3	2,2	1050	400/3/50	10	DOL	74	1530 x 595 x 1140	141	No
S A39B 270 CT4	4116007357	TM	486	Electric	ALTAIR PRO	A39B	270	4	3	1300	400/3/50	10	DOL	74	1530 x 595 x 1140	141	No
S A39B 270 FM3	4116007366	TM	393	Electric	ALTAIR PRO	A39B	270	3	2,2	1050	230/1/50	10	DOL	74	1530 x 595 x 1140	141	No
S A39B 270 FT3	4116007367	TM	393	Electric	ALTAIR PRO	A39B	270	3	2,2	1050	400/3/50	10	DOL	74	1530 x 595 x 1140	141	No
S A39B 270 FT4	4116007369	TM	486	Electric	ALTAIR PRO	A39B	270	4	3	1300	400/3/50	10	DOL	74	1530 x 595 x 1140	141	No



LN0 27 LT - Silent

The ABAC LN0 27 - Silent piston air compressor has been designed for demanding professionals, however it is an excellent solution even for advanced amateurs thanks to its efficiency, stability and reliability.

Thanks to the control panel with pressure regulator, pressure gauges and hour counter, it guarantees an ease to use interface.

Model	Part Number	Canopy Size	Configuration	l/min	Engine	Oil	Pump	L	HP	kW	Rpm	Voltz	Bar	Start type	dB(A)	LxWxH (mm)	KG	Dryer
LN0 A29 27 M2 DOL	4116026077	S0	BM	255	Electric	ALTAIR PRO	A29	27	2	1,5	1075	230/1/50	10	DOL	61	761 x 430 x 845	86	No
LN0 A29 27 T2 DOL	4116026328	S0	BM	255	Electric	ALTAIR PRO	A29	27	2	1,5	1075	400/3/50	10	DOL	61	761 x 430 x 845	86	No
LN0 A29B 27 M3 DOL	4116026329	S0	BM	320	Electric	ALTAIR PRO	A29B	27	3	2,2	1300	230/1/50	10	DOL	62	761 x 430 x 845	87	No
LN0 A29B 27 M3 DOL MEPS	4116026331	S0	BM	320	Electric	ALTAIR PRO	A29B	27	3	2,2	1300	230/1/50	10	DOL	62	761 x 430 x 845	87	No
LN0 A29B 27 T3 DOL	4116026330	S0	BM	320	Electric	ALTAIR PRO	A29B	27	3	2,2	1300	400/3/50	10	DOL	62	761 x 430 x 845	87	No

LN1 0 LT - Silent



With an efficient cooling system with large flywheel, the LN1 0 LT - Silent is a silent belt drive piston compressor that ensures lower noise level.

Model	Part Number	Canopy Size	Configuration	l/min	Engine	Oil	Pump	L	HP	kW	Rpm	Voltz	Bar	Start type	dB(A)	LxWxH (mm)	KG	Dryer
LN1 A39B 0 T4 DOL	4116026050	S1	BM	490	Electric	ALTAIR PRO	A39B	0	4	3	1300	400/3/50	10	DOL	68	750 x 580 x 761	170	No
LN1 A49B 0 T4 DOL	4116026049	S1	BM	553	Electric	ALTAIR PRO	A49B	0	4	3	1300	400/3/50	11	DOL	69	750 x 580 x 761	170	No
LN1 A49B 0 T5,5 DOL	4116026053	S1	BM	598	Electric	ALTAIR PRO	A49B	0	5,5	4,1	1400	400/3/50	11	DOL	69	750 x 580 x 761	170	No
LN1 B5900 0 T5,5 DOL	4116026059	S1	BM	570	Electric	ALTAIR PRO	B5900B	0	5,5	4,1	1200	400/3/50	11	DOL	67	750 x 580 x 761	170	No

LN1 100 LT - Silent



The LN1 100 LT - Silent is tailored for demanding professionals. However, features such as efficacy, stability and trustworthiness, make it a suitable option for advanced amateurs as well.

Model	Part Number	Canopy Size	Configuration	l/min	Engine	Oil	Pump	L	HP	kW	Rpm	Voltz	Bar	Start type	dB(A)	LxWxH (mm)	KG	Dryer
LN1 A39B 100 M3 DOL	4116026392	S1	TM	393	Electric	ALTAIR PRO	A39B	100	3	2,2	1050	230/1/50	10	DOL	65	1067 x 580 x 1060	180	No
LN1 A39B 100 T3 DOL	4116026393	S1	TM	393	Electric	ALTAIR PRO	A39B	100	3	2,2	1050	400/3/50	10	DOL	65	1067 x 580 x 1060	180	No

LN1 270 LT - Silent



The LN1 270 LT - Silent, is included in the Professional stationary silent category and tailored for demanding professionals. However, features such as efficacy, stability and trustworthiness, make it a suitable option for advanced amateurs as well. This range is perfect for intermittent or frequent use.

Model	Part Number	Canopy Size	Configuration	l/min	Engine	Oil	Pump	L	HP	kW	Rpm	Voltz	Bar	Start type	dB(A)	LxWxH (mm)	KG	Dryer
LN1 A39B 270 M3 DOL	4116026047	S1	TM	393	Electric	ALTAIR PRO	A39B	270	3	2,2	1050	230/1/50	10	DOL	65	1522 x 580 x 1242	248	No
LN1 A39B 270 T3 DOL	4116026048	S1	TM	393	Electric	ALTAIR PRO	A39B	270	3	2,2	1050	400/3/50	10	DOL	65	1522 x 580 x 1242	248	No
LN1 A39B 270 T4 DOL	4116026052	S1	TM	490	Electric	ALTAIR PRO	A39B	270	4	3	1300	400/3/50	10	DOL	69	1522 x 580 x 1242	248	No
LN1 A49B 270 T4 DOL	4116026051	S1	TM	553	Electric	ALTAIR PRO	A49B	270	4	3	1300	400/3/50	11	DOL	69	1522 x 580 x 1242	248	No
LN1 A49B 270 T5,5 DOL	4116026055	S1	TM	598	Electric	ALTAIR PRO	A49B	270	5,5	4,1	1400	400/3/50	11	DOL	69	1522 x 580 x 1242	248	No



LN1 270 LT - Silent

The LN1 270 LT - Silent, is included in the Professional stationary silent category and tailored for demanding professionals. However, features such as efficacy, stability and trustworthiness, make it a suitable option for advanced amateurs as well. This range is perfect for intermittent or frequent use.

Model	Part Number	Canopy Size	Configuration	l/min	Engine	Oil	Pump	L	HP	kW	Rpm	Voltz	Bar	Start type	dB(A)	LxWxH (mm)	KG	Dryer
LN1 B5900 270 T5,5 DOL	4116026060	S1	TM	570	Electric	ALTAIR PRO	B5900B	270	5,5	4,1	1200	400/3/50	11	DOL	67	1575 x 680 x 1150	248	No



LN1 500 LT - Silent

Included in the professional stationary silent category, the LN1 500 LT - Silent is tailored for professional and perfect for frequent use.

Model	Part Number	Canopy Size	l/min	Engine	Oil	Pump	L	HP	kW	Rpm	Voltz	Bar	Start type	dB(A)	LxWxH (mm)	KG	Dryer
LN1 A49B 500 T5,5 DOL	4116026057	S1	598	Electric	ALTAIR PRO	A49B	500	5,5	4,1	1400	400/3/50	11	DOL	69	1937 x 580 x 1348	274	No
LN1 B5900 500 T5,5 DOL	4116026061	S1	570	Electric	ALTAIR PRO	B5900B	500	5,5	4,1	1200	400/3/50	11	DOL	67	1937 x 580 x 1348	274	No



LN2 0 LT - Silent

The LN2 0 LT - Silent comes with a pressure gauge on the front panel making the compressor an easy to read and reliable solution.

Model	Part Number	Canopy Size	Configuration	l/min	Engine	Oil	Pump	L	HP	kW	Rpm	Voltz	Bar	Start type	dB(A)	LxWxH (mm)	KG	Dryer
LN2 A49B 0 T4 DOL	4116026000	S2	BM	553	Electric	ALTAIR PRO	A49B	0	4	3	1300	400/3/50	11	DOL	69	1000 x 738 x 955	170	No
LN2 B5900 0 T5,5 DOL	4116026002	S2	BM	570	Electric	ALTAIR PRO	B5900B	0	5,5	4,1	1200	400/3/50	11	DOL	67	1000 x 738 x 955	177	No
LN2 B5900 0 T5,5 DOL MEPS	4116026004	S2	BM	570	Electric	ALTAIR PRO	B5900B	0	5,5	4,1	1200	400/3/50	11	DOL	67	1000 x 738 x 955	177	No
LN2 B5900 0 T5,5 YD	4116026003	S2	BM	570	Electric	ALTAIR PRO	B5900B	0	5,5	4,1	1200	400/3/50	11	Y/D	67	1000 x 738 x 955	181	No
LN2 B6000 0 T7,5 DOL 10B	4116026013	S2	BM	660	Electric	ALTAIR PRO	B6000	0	7,5	5,6	1150	400/3/50	10	DOL	68	1000 x 738 x 955	240	No
LN2 B6000 0 T7,5 DOL MEPS	4116026014	S2	BM	660	Electric	ALTAIR PRO	B6000	0	7,5	5,6	1150	400/3/50	12	DOL	68	1000 x 738 x 955	240	No
LN2 B6000 0 T7,5 YD	4116026012	S2	BM	660	Electric	ALTAIR PRO	B6000	0	7,5	5,6	1150	400/3/50	11	Y/D	68	1000 x 738 x 955	240	No
LN2 B7000 0 T10 DOL	4116026019	S2	BM	1070	Electric	ALTAIR PRO	B7000	0	10	7,5	1150	400/3/50	11	DOL	68	1000 x 738 x 955	253	No



LN2 0 LT - Silent

The LN2 0 LT - Silent comes with a pressure gauge on the front panel making the compressor an easy to read and reliable solution.

Model	Part Number	Canopy Size	Configuration	l/min	Engine	Oil	Pump	L	HP	kW	Rpm	Voltz	Bar	Start type	dB(A)	LxWxH (mm)	KG	Dryer
LN2 B7000 0 T10 DOL 10B	4116026022	S2	BM	1070	Electric	ALTAIR PRO	B7000	0	10	7,5	1150	400/3/50	10	DOL	68	1000 x 738 x 955	253	No
LN2 B7000 0 T10 DOL MEPS	4116026021	S2	BM	1070	Electric	ALTAIR PRO	B7000	0	10	7,5	1150	400/3/50	15	DOL	68	1000 x 738 x 955	253	No
LN2 B7000 0 T10 YD	4116026020	S2	BM	1070	Electric	ALTAIR PRO	B7000	0	10	7,5	1150	400/3/50	11	Y/D	68	1000 x 738 x 955	253	No



LN2 270 LT - Silent

The LN2 270 LT - Silent range is included in the Professional stationary silent category and tailored for demanding professionals. However, features such as efficacy, stability and trustworthiness, make it a suitable option for advanced amateurs as well.

Model	Part Number	Canopy Size	Configuration	l/min	Engine	Oil	Pump	L	HP	kW	Rpm	Voltz	Bar	Start type	dB(A)	LxWxH (mm)	KG	Dryer
LN2 A49B 270 T4 DOL	4116026001	S2	TM	553	Electric	ALTAIR PRO	A49B	270	4	3	1300	400/3/50	11	DOL	69	1516 x 738 x 1513	238	No
LN2 B5900 270 T5,5 DOL	4116026005	S2	TM	570	Electric	ALTAIR PRO	B5900B	270	5,5	4,1	1200	400/3/50	11	DOL	67	1575 x 680 x 1150	153	No
LN2 B5900 270 T5,5 YD	4116026006	S2	TM	570	Electric	ALTAIR PRO	B5900B	270	5,5	4,1	1200	400/3/50	11	Y/D	67	1575 x 680 x 1150	252	No



LN2 500 LT - Silent

With an easy access to internal components, the LN2 500 LT - Silent piston compressor provides high performance with a lower noise level.

Model	Part Number	Canopy Size	Configuration	l/min	Engine	Oil	Pump	L	HP	kW	Rpm	Voltz	Bar	Start type	dB(A)	LxWxH (mm)	KG	Dryer
LN2 B5900 500 T5,5 DOL	4116026007	S2	TM	570	Electric	ALTAIR PRO	B5900B	500	5,5	4,1	1200	400/3/50	11	DOL	67	1943 x 738 x 1593	302	No
LN2 B5900 500 T5,5 DOL DRY	4116026009	S2	TMD	570	Electric	ALTAIR PRO	B5900B	500	5,5	4,1	1200	400/3/50	11	DOL	67	1943 x 738 x 1593	302	Yes
LN2 B5900 500 T5,5 YD	4116026008	S2	TM	570	Electric	ALTAIR PRO	B5900B	500	5,5	4,1	1200	400/3/50	11	Y/D	67	1943 x 738 x 1593	306	No
LN2 B5900 500 T5,5 YD DRY	4116026010	S2	TMD	570	Electric	ALTAIR PRO	B5900B	500	5,5	4,1	1200	400/3/50	11	Y/D	67	1943 x 738 x 1593	306	Yes
LN2 B6000 500 T7,5 DOL	4116026015	S2	TM	660	Electric	ALTAIR PRO	B6000	500	7,5	5,6	1150	400/3/50	11	DOL	68	1943 x 738 x 1593	404	No



LN2 500 LT - Silent

With an easy access to internal components, the LN2 500 LT - Silent piston compressor provides high performance with a lower noise level.

Model	Part Number	Canopy Size	Configuration	l/min	Engine	Oil	Pump	L	HP	kW	Rpm	Voltz	Bar	Start type	dB(A)	LxWxH (mm)	KG	Dryer
LN2 B6000 500 T7,5 DOL DRY	4116026017	S2	TMD	660	Electric	ALTAIR PRO	B6000	500	7,5	5,6	1150	400/3/50	11	DOL	68	1943 x 738 x 1593	404	Yes
LN2 B6000 500 T7,5 YD	4116026016	S2	TM	660	Electric	ALTAIR PRO	B6000	500	7,5	5,6	1150	400/3/50	11	Y/D	68	1943 x 738 x 1593	404	No
LN2 B6000 500 T7,5 YD DRY	4116026018	S2	TMD	660	Electric	ALTAIR PRO	B6000	500	7,5	5,6	1150	400/3/50	11	Y/D	68	1943 x 738 x 1593	404	Yes
LN2 B7000 500 T10 DOL	4116026023	S2	TM	1070	Electric	ALTAIR PRO	B7000	500	10	7,5	1150	400/3/50	11	DOL	68	1943 x 738 x 1593	448	No
LN2 B7000 500 T10 DOL DRY	4116026025	S2	TMD	1070	Electric	ALTAIR PRO	B7000	500	10	7,5	1150	400/3/50	11	DOL	68	1943 x 738 x 1593	448	Yes
LN2 B7000 500 T10 YD	4116026024	S2	TM	1070	Electric	ALTAIR PRO	B7000	500	10	7,5	1150	400/3/50	11	Y/D	68	1943 x 738 x 1593	448	No
LN2 B7000 500 T10 YD DRY	4116026026	S2	TMD	1070	Electric	ALTAIR PRO	B7000	500	10	7,5	1150	400/3/50	11	Y/D	68	1943 x 738 x 1593	448	Yes

Piston Compressors Engine Driven



Piston Compressors Engine Driven

Take the power of air everywhere, with plug-free, versatile, multi-purpose, petrol/diesel powered range of ABAC.

Petrol

ABAC has developed specific products for compressed air applications where there is no electricity supply. ABAC'S petrol oil lubricated air compressors are what make your job possible giving you versatility and high quality performances everywhere.

102

Diesel

No electricity ? No problem. Our diesel oil lubricated air compressors are versatile and have high quality performances, helping you get the job done everywhere.

106



EngineAIR 2.5 LT - Petrol

The EngineAIR 2.5 LT - benzina has been designed for demanding professionals. Ideal for frequent use it is also easy to move thanks to its portable configuration.

Model	Part Number	Configuration	l/min	Engine	Fuel	Pump	L	HP	kW	Rpm	Bar	dB(A)	LxWxH (mm)	KG	Dryer
engineAIR 5/2,5 10 Petrol	1121440133	TM	275	GP160	Petrol	SI5	2,5	4,8	3,576	3400	10	96	620 x 410 x 480	28	No



EngineAIR 4 LT - Petrol

Tailored for professionals, the EngineAIR 4 LT - benzina has exceptional characteristics of reliability, stability and robustness which make it a product suitable for different needs.

Model	Part Number	Configuration	l/min	Engine	Fuel	Pump	L	HP	kW	Rpm	Bar	dB(A)	LxWxH (mm)	KG	Dryer
engineAIR 5/4 10 Petrol	1121440134	TM	275	GP160	Petrol	SI5	4	4,8	3,576	3400	10	96	530 x 440 x 440	29	No



EngineAIR 20 LT - Petrol

The EngineAIR 20 LT - benzina has a lower noise level and a Mobile configuration that allows easy movement of the product.

Model	Part Number	Configuration	l/min	Engine	Fuel	Pump	L	HP	kW	Rpm	Bar	dB(A)	LxWxH (mm)	KG	Dryer
engineAIR 5/20 10 Petrol	1121440135	TM	275	GP160	Petrol	SI5	20	4,8	3,576	3400	10	96	610 x 460 x 850	40	No

EngineAIR 22 LT - Petrol



The EngineAIR 22 LT - benzina has been designed for professionals, however it is an excellent solution even for advanced amateurs thanks to its reliability, stability and robustness.

Model	Part Number	Configuration	l/min	Engine	Fuel	Pump	L	HP	kW	Rpm	Bar	dB(A)	LxWxH (mm)	KG	Dryer
engineAIR 4/22 10 Petrol	1121440136	TM	320	GP160	Petrol	A29B	22	4,8	3,576	1350	10	95	740 x 470 x 850	54	No

EngineAIR 11+11 LT - Petrol



Designed for professionals and advanced amateurs, the EngineAIR 11+11 LT - benzina comes with an oil lubricated configuration, that allows simple maintenance operations to be carried out quickly and easily.

Model	Part Number	Configuration	l/min	Engine	Fuel	Pump	L	HP	kW	Rpm	Bar	dB(A)	LxWxH (mm)	KG	Dryer
engineAIR 5/11+11 10 Petrol	1121440114	TM	411	GX160	Petrol	A39B	22	4,8	3,576	1070	10	96	1230 x 710 x 750	70	No
engineAIR 5/11+11R 10 Petrol	1121440115	TM	411	GP160	Petrol	A39B	22	4,8	3,576	1070	10	96	1230 x 710 x 800	78	No

EngineAIR 24 LT - Petrol



The EngineAIR 24 LT - benzina has a lower noise level and a Mobile configuration that allows easy movement of the product.

Model	Part Number	Configuration	l/min	Engine	Fuel	Pump	L	HP	kW	Rpm	Bar	dB(A)	LxWxH (mm)	KG	Dryer
engineAIR 5/24 10 Petrol	1121440137	TM	411	GP160	Petrol	A39B	24	4,8	3,576	1070	10	96	850 x 560 x 770	60	No



EngineAIR 17+17 LT - Petrol

Designed for professionals and advanced amateurs, the EngineAIR 17+17 LT - benzina comes with an oil injected configuration, that reduces maintenance costs and allows simple maintenance operations to be carried out quickly and easily.

Model	Part Number	Configuration	l/min	Engine	Fuel	Pump	L	HP	kW	Rpm	Bar	dB(A)	LxWxH (mm)	KG	Dryer
engineAIR 9/17+17 S 10 Petrol	1121440125	TM	552	GX270	Petrol	B5900B	34	8,4	6,258	1160	10	97	1480 x 760 x 850	107	No



EngineAIR 50 LT - Petrol

The EngineAIR 22 LT - benzina has been designed for professionals and it is an excellent solution thanks to its reliability, stability and robustness.

Model	Part Number	Configuration	l/min	Engine	Fuel	Pump	L	HP	kW	Rpm	Bar	dB(A)	LxWxH (mm)	KG	Dryer
engineAIR 9/50 10 Petrol	1121440117	TM	552	GX270	Petrol	B5900B	50	8,4	6,258	1160	10	97	1270 x 0910 x 910	100	No
engineAIR 9/50 14 Petrol	1121440124	TM	524	GX270	Petrol	B5900B	50	8,4	6,258	1100	14	97	1270 x 0910 x 910	100	No
engineAIR 5/50 10 Petrol	1121440110	TM	411	GP160	Petrol	A39B	50	4,8	3,576	1070	10	96	980 x 440 x 780	66	No



EngineAIR 100 LT - Petrol

The EngineAIR 100 LT - benzina has a lower noise level and a Mobile configuration that allows easy movement of the product.

Model	Part Number	Configuration	l/min	Engine	Fuel	Pump	L	HP	kW	Rpm	Bar	dB(A)	LxWxH (mm)	KG	Dryer
engineAIR 4/100 10 Petrol	1121440138	TM	320	GP160	Petrol	A29B	100	4,8	3,576	1350	10	95	1110 x 520 x 940	70	No
engineAIR 5/100 10 Petrol	1121440112	TM	411	GP160	Petrol	A39B	100	4,8	3,576	1070	10	96	1110 x 520 x 940	72	No



EngineAIR 200 LT - Petrol

Tailored for professionals and advanced amateurs, the EngineAIR 200 LT - benzina has exceptional characteristics of reliability, stability and robustness which make it a product suitable for different needs.

Model	Part Number	Configuration	l/min	Engine	Fuel	Pump	L	HP	kW	Rpm	Bar	dB(A)	LxWxH (mm)	KG	Dryer
engineAIR 5/200 10 Petrol	1121440113	TM	411	GP160	Petrol	A39B	200	4,8	3,576	1070	10	96	1510 x 1110 x 1010	98	No



EngineAIR 270 LT - Petrol

The EngineAIR 270 LT - benzina has been designed for professionals and it is an excellent solution thanks to its reliability, stability and robustness.

Model	Part Number	Configuration	l/min	Engine	Fuel	Pump	L	HP	kW	Rpm	Bar	dB(A)	LxWxH (mm)	KG	Dryer
engineAIR 9/270 Petrol	1121440121	TM	552	GX270	Petrol	B5900B	270	8,4	6,258	1160	10	97	1540 x 1150 x 1160	170	No
engineAIR 12/270 10 ES Petrol	1121440119	TM	676	GX390	Petrol	B6000B	270	11,7	8,7165	1185	10	97	1540 x 1230 x 1080	185	No
engineAIR 12/270 14 ES Petrol	1121440122	TM	633	GX390	Petrol	B6000B	270	11,7	8,7165	1110	14	97	1540 x 1100 x 1080	185	No
engineAIR 12/270 S ES Petrol	1121440123	TM	972	GX390	Petrol	B7000	270	11,7	8,7165	1045	14	98	1540 x 520 x 1080	195	No



BI EngineAIR 90 LT - Diesel

The BI EngineAIR 90 LT - Diesel is an easy to use compressor that provides high quality air and easy maintenance thanks to the external industrial filter for benzina engine.

Model	Part Number	Configuration	l/min	Engine	Fuel	Pump	L	HP	kW	Rpm	Bar	dB(A)	LxWxH (mm)	KG	Dryer
BI engineAIR 17/90 12 ES Diesel	1121440116	TM	765	LDW702	Diesel	AB998	90	17	12,665	900	12	96	1050 x 2150 x 1730	378	No



EngineAIR 270 LT - Diesel

With a Mobile configuration, the EngineAIR 270 LT - Diesel in an easy to move compressor and a good solution to reduce maintenance cost.

Model	Part Number	Configuration	l/min	Engine	Fuel	Pump	L	HP	kW	Rpm	Bar	dB(A)	LxWxH (mm)	KG	Dryer
engineAIR 7/270 Diesel	1121440128	TM	541	KD350	Diesel	B5900B	270	7,1	52,895	1135	10	97	1540 x 1220 x 1220	184	No
engineAir 10/270 14 ES Diesel	1121440129	TM	727	KD15-440	Diesel	B6000B	270	10,1	75,245	1275	14	98	1540 x 1150 x 1140	198	No
engineAIR 11/270 14 ES Diesel	1121440130	TM	1038	KD15-440	Diesel	B7000	270	10,1	75,245	1115	14	98	1540 x 520 x 1140	208	No



BI EngineAIR 270 LT - Diesel

With sturdy metal grid that protects all moving parts, the BI EngineAIR 270 LT - Diesel is a safety and user-friendly solution designed for professionals.

Model	Part Number	Configuration	l/min	Engine	Fuel	Pump	L	HP	kW	Rpm	Bar	dB(A)	LxWxH (mm)	KG	Dryer
BI engineAIR 11/270 14 ES Diesel	1121440132	TM	605	KD15-440	Diesel	B6000B	270	10,1	75,245	1060	14	98	1540 x 1200 x 1180	257	No



Professional and DIY Tools

Air. Anytime. Anywhere.





How to choose your tools

ABAC's range of air tools and accessories is tailored to professional needs with products designed to be user-friendly, ergonomic and durable.



Featuring pneumatic tools and accessories, this section complements the existing compressed air solution range offered by ABAC. With one of the largest compressor portfolios on the market, a full air treatment equipment portfolio and state-of-the-art distribution systems, ABAC provides perfect compressed air delivery and quality for every application.

Well-suited Very well-suited

Impact wrench

	 2809913100 1/2" mini PRO	 2809913101 1/2" Comp PRO	 2809913102 3/4" Comp PRO	 2809913103 1" Comp PRO	 2809913104 1" L Comp PRO
Application					
Car wheels	●	●			
Car axles		●			
Car engines	●				
Car body	●				
Light truck wheels			●		
Light truck axles			●	●	
Light truck engines		●			
Light truck body	●	●			
Truck wheels				●	●
Truck axles			●	●	
Truck engines		●	●		
Truck body		●			
Metal construction	●	●	●		
Wood construction		●	●	●	

Ratchet wrench

	 2809913150 1/4" PRO	 2809913151 1/2" PRO	 2809913152 1/2" Imp. PRO
Application			
Car interior	●		
Engine service		●	●
Vehicle brakes		●	●
Vehicle axles			●







Screws

	 2809913170 Straight PRO	 2809913171 1/2" pistol Comp PRO
Application		
Furniture manufacture	●	●
Assembly	●	●
Hanging/mounting	●	





Drill

	 2809913190 Drill 10mm Comp PRO
Application	
Automotive	●
Wood sector	●
Metal sector	●
Assembly industry	●

Sander and grinder

							
	2809913200 Die grinder PRO	2809913201 Angle die grinder PRO	2809913204 Die Grinder Long PRO	2809913202 Angle grinder 125 Comp PRO	2809913203 Long neck angle grinder PRO	2809913250 Belt Sander 330-10 PRO	2809913251 Orbital San- der 150 Comp PRO
Application							
Grinding in corners	●	●	●			●	
Deburring	●	●		●		●	
Weld grinding	●	●	●	●		●	
Metal cutting				●	●		
Furniture sanding							●
Car body sanding							●



Hammer

					
	2809913400 Chisel hammer 10mm PRO	2809913401 Chisel hammer 12mm PRO	2809913450 Needle scaler 12 PRO	2809913451 Needle scaler 19 PRO	2809913452 Needle scaler 28 PRO
Application					
Tile removal	●				
Chipping	●	●			
Plaster removal	●	●			●
Breaking through walls		●			
Creating cable ducts	●				
Stone processing				●	●
Weld slag removal			●	●	●
Rust removal			●	●	●
Colour particle removal			●	●	
Restoring reinforcing steel					●

Saw

	
	2809913700 Saw Comp PRO
Application	
Cutting steel	●
Cutting aluminium	●
Cutting plastic	●

Tyre inflator

		
	2809913620 Tyre inflator PRO CEE QL	2809913621 1/2" Tyre inflator PRO CEE TR
Application		
Inflating motorbike tyres	●	
Inflating car tyres	●	●
Inflating truck tyres	●	●
Inflating bus tyres		●
Inflating twin tyres		●

Air Tools

ABAC
RACING TEAM



Air Tools

ABAC offers a broad range of powerful, reliable pneumatic tools for a variety of applications, suited for many types of use from DIY to professional and light industrial use.

Professional

ABAC Professional tools are the ideal partner for intensive or complex jobs. Covering a broad range of applications and with impressive performance combined with user-friendly ergonomics, they are perfect for the premium finish required by the most demanding activities.

112

DIY & Hobby

Discover the range of high value and performance ABAC tools, optimised for DIY and hobby applications.

121



Impact Wrench 1/2" PRO mini

Compact impact wrench with high performance twin-hammer clutch for professional application at assembly industry and car workshops. Very compact body makes the tool very suitable for working in tight spaces. High performance twin-hammer clutch for quicker power build-up and high release torque. Excellent weight-performance ratio, generates up to 700 Nm torque with a weight of 1,1kg. Less work fatigue due to optimized centre of gravity and ergonomic handle design

Model	Part Number	l/min	l/sec	Rpm	Bar	LxWxH (mm)	KG	Air Fitting	Working Torque Nm	Maximum Breakaway Torque Nm	Square	Max. Vibration EN-ISO 28927-9
Impact wrench 1/2" PRO mini	2809913100	318	5,3	9000	6,3	121 x 63 x 170	1,1	1/4"	440	700	1/2"	5



Impact Wrench 1/2" Comp PRO

Powerful impact wrench for universal applications. Lightweight composite housing. High performance twin hammer system. Rubber handle grip.

Model	Part Number	l/min	l/sec	Rpm	Bar	LxWxH (mm)	KG	Air Fitting	Working Torque Nm	Maximum Breakaway Torque Nm	Square	Max. Vibration EN-ISO 28927-9
Impact wrench 1/2" Comp PRO	2809913101	552	9,2	7500	6,3	207 x 68 x 194	2,1	1/4"	1100	1750	1/2"	7,3



Impact Wrench 3/4" Comp PRO

Powerful impact wrench for light truck and van applications. Lightweight composite housing. High performance twin hammer system. Ergonomic housing design.

Model	Part Number	l/min	l/sec	Rpm	Bar	LxWxH (mm)	KG	Air Fitting	Working Torque Nm	Maximum Breakaway Torque Nm	Square	Max. Vibration EN-ISO 28927-9
Impact wrench 3/4" Comp PRO	2809913102	546	9,1	5500	6,3	214 x 83 x 266	3,7	1/4"	1629	2978	3/4"	4,8



Impact Wrench 1" Comp PRO

Powerful impact wrench for truck and bus applications. Lightweight composite housing. High performance twin hammer system. Ergonomic housing design.

Model	Part Number	l/min	l/sec	Rpm	Bar	LxWxH (mm)	KG	Air Fitting	Working Torque Nm	Maximum Breakaway Torque Nm	Square	Max. Vibration EN-ISO 28927-9
Impact wrench 1" Comp PRO	2809913103	546	9,1	5500	6,3	214 x 83 x 266	3,7	1/4"	1900	3150	1"	4,8

Impact Wrench 1" L Comp PRO



Heavy-duty impact wrench for light truck and van applications. Lightweight, compact composite housing. High performance twin hammer system. Ergonomic housing design.

Model	Part Number	l/min	l/sec	Rpm	Bar	LxWxH (mm)	KG	Air Fitting	Working Torque Nm	Maximum Breakaway Torque Nm	Square	Max. Vibration EN-ISO 28927-9
Impact wrench 1" L COMP PRO	2809913104	1440	24	5000	6,3	527 x 213 x 176	13,4	1/2"	2700	4356	1"	18,2

Ratchet Wrench 1/4" PRO



Compact size for narrow space vehicle cabin and engine applications. Compact design. Rubber handle grip. Rubber protection on ratchet head.

Model	Part Number	l/min	l/sec	Rpm	Bar	LxWxH (mm)	KG	Air Fitting	Working Torque Nm	Square	Max. Vibration EN-ISO 28927-9
Ratchet wrench 1/4" PRO	2809913150	300	5	200	6,3	177 x 41 x 49	0,5	1/4"	41	1/4"	1,8

Ratchet Wrench 1/2" PRO



Universal ratchet wrench for various applications. Adjustable power. Rubber handle grip. Protective rubber on ratchet head.

Model	Part Number	l/min	l/sec	Rpm	Bar	LxWxH (mm)	KG	Air Fitting	Working Torque Nm	Square	Max. Vibration EN-ISO 28927-9
Ratchet wrench 1/2" PRO	2809913151	360	6	150	6,3	256 x 48 x 56	1,2	1/4"	68	1/2"	2,6

Ratchet Wrench 1/2" Imp. PRO



Powerful ratchet wrench with impact system. Rubber handle grip. No kickback.

Model	Part Number	l/min	l/sec	Rpm	Bar	LxWxH (mm)	KG	Air Fitting	Working Torque Nm	Square	Max. Vibration EN-ISO 28927-9
Ratchet wrench 1/2" Imp. PRO	2809913152	360	6	600	6,3	279 x 46 x 57	1,46	1/4"	122	1/2"	12,2

Screw Driver straight PRO



Compact screwdriver for professional use in wood- and metalworking industries. Anti-slip, ergonomic handle. Extremely low noise due to exhaust air silencer. Stemless torque adjustment on the outer adjusting ring allows for flexible working. Suitable for hanging on balancers.

Model	Part Number	l/min	l/sec	Rpm	Bar	LxWxH (mm)	KG	Air Fitting	Working Torque Nm	Size	Max. Vibration EN-ISO 28927-9
Screw driver straight PRO	2809913170	480	8	1800	6,3	244 x 51 x 79	1,2	1/4"	8	1/4"	0,5



Screw Driver pistol Comp PRO

Lightweight screwdriver for professional use in the wood and metalworking industries. Super-lightweight and ergonomic composite housing. Very quiet thanks to built-in silencer. Switch from clockwise to anticlockwise operation with one hand to save time. Stemless torque adjustment on the outer adjusting ring allows for flexible working.

Model	Part Number	l/min	l/sec	Rpm	Bar	LxWxH (mm)	KG	Air Fitting	Working Torque Nm	Size	Max. Vibration EN-ISO 28927-9
Screw driver pistol Comp PRO	2809913171	480	8	1800	6,3	210 x 43 x 150	1,1	1/4"	8	1/4"	0,8



Drill Comp PRO

Powerful drill for professional use in wood and metalworking industries, and car workshops. Powerful thanks to the high-performance compressed air motor. Super-lightweight and ergonomic composite housing. Switch from clockwise to anticlockwise operation with one hand to save time. Very quiet thanks to built-in silencer.

Model	Part Number	l/min	l/sec	Rpm	Bar	LxWxH (mm)	KG	Air Fitting	Working Torque Nm	Size	Max. Vibration EN-ISO 28927-9
Drill 10mm Comp PRO	2809913190	480	8	2000	6,3	188 x 43 x 150	1	1/4"	10	10mm	2,1



Die Grinder PRO

Compact die grinder for professional use in car workshops and metalworking industry. Universal applications, including 3 & 6 mm collet chucks that are suitable for most common accessories. Quick work progress due to high speed. Comfortable operation thanks to the swivel air inlet that makes the tool very flexible, especially in hard-to-access areas. Reduced fatigue due to light weight.

Model	Part Number	l/min	l/sec	Rpm	Bar	LxWxH (mm)	KG	Air Fitting	Size	Max. Vibration EN-ISO 28927-9
Die grinder PRO	2809913200	240	4	25000	6,3	159 x 39 x 60	0,4	1/4"	3-6mm	1,24

Angle Die Grinder PRO



Angle die grinder for multiple applications in tight spaces. Compact design and lightweight. Ergonomic rubber handle with reduced vibration. Rotatable air connection for greater flexibility. Incl. 3 mm and 6 mm collet chuck.

Model	Part Number	l/min	l/sec	Watt	Rpm	Bar	LxWxH (mm)	KG	Air Fitting	Size	Max. Vibration EN-ISO 28927-9
Angle die grinder PRO	2809913201	240	4	220	20000	6,3	181 x 45 x 79	0,7	1/4"	3-6mm	1,24

Die Grinder Long PRO



Extended die grinder for multiple applications. Ergonomic rubber handle with reduced vibration. Rotatable air connection for greater flexibility. Incl. 3 mm and 6 mm collet chuck.

Model	Part Number	l/min	l/sec	Watt	Rpm	Bar	LxWxH (mm)	KG	Air Fitting	Max. Vibration EN-ISO 28927-9
Die Grinder Long PRO	2809913204	240	4	220	25000	6,3	256 x 60 x 39	0,7	1/4"	1,24

Angle grinder 125 Comp PRO



Powerful angle grinder for professional use in the metalworking industry. Extremely quick grinding disc change thanks to spindle stop. Rubber side grip can be installed for left and right-handed individuals. Protective hood can be adjusted without tools, for protection against sparks. For standard grinding wheels up to dia. 125 mm.

Model	Part Number	l/min	l/sec	Watt	Rpm	Bar	LxWxH (mm)	KG	Air Fitting	Size	Max. Vibration EN-ISO 28927-9
Angle grinder 125 Comp PRO	2809913202	660	11	220	12000	6,3	229 x 207 x 92	2	1/4"	125mm	6,5

Long neck angle grinder PRO



High performance cut-off tool for professional use in car workshops. Extremely quick grinding disc change, thanks to spindle stop. Long neck and low profile angle head offers good accessibility. Protective hood can be adjusted without tools, for protection against sparks. For cut-off wheels 100 x 1 x 16 mm.

Model	Part Number	l/min	l/sec	Watt	Rpm	Bar	LxWxH (mm)	KG	Air Fitting	Size	Max. Vibration EN-ISO 28927-9
Long neck angle grinder PRO	2809913203	840	14	660	14000	6,3	372 x 112 x 59	1,7	1/4"	125mm	3,8

Belt Sander 330-10 PRO



Compact belt sander for professional use in wood and metalworking industries and car workshops. Exhaust air guide towards the rear prevents swarf dispersion. Actuating lever with trigger safety device. Automatic belt tensioner for easy abrasive belt changing.

Model	Part Number	l/min	l/sec	Watt	Rpm	Bar	LxWxH (mm)	KG	Air Fitting	Size	Max. Vibration EN-ISO 28927-9
Belt Sander 330-10 PRO	2809913250	402	6,7	700	20000	6,3	330 x 84 x 104	0,85	1/4"	10x330	1,3

Orbital Sander 150 Comp PRO



Universal orbital sander with 5mm stroke. Fatigue-free grinding thanks to reduced vibrations. Unlimited view of the workpiece with narrow collar. Particularly low air consumption. Suitable for standard 150mm, 15-hole, 8-hole and 6-hole sanding paper.

Model	Part Number	l/min	l/sec	Rpm	Bar	LxWxH (mm)	KG	Air Fitting	Size	Max. Vibration EN-ISO 28927-9
Orbital Sander 150 Comp PRO	2809913251	420	7	12000	6,3	214 x 83 x 266	0,84	1/4"	150mm	3,73



Chisel hammer 10mm PRO

Robust chisel hammer with durable stroke mechanism for professional use in metalworking and construction trade sectors. Stepless adjustment of impact power to suit different materials. Extreme versatility from chiselling tiles and plaster, to slits and metal sheet curving. Reduced fatigue thanks to its compact, lightweight design.

Model	Part Number	l/min	l/sec	Rpm	Bar	LxWxH (mm)	KG	Air Fitting	Size	Max. Vibration EN-ISO 28927-9
Chisel hammer 10mm PRO	2809913400	642	10,7	4500	6,3	189 x 52 x 175	1,9	1/4"	10mm	12,31



Chisel hammer 12mm PRO

Highest impact energy for the toughest materials. Chisel cap made from hardened steel for longer service time and quick chisel change. Incl. pointed and flat chisel, 250 mm long.

Model	Part Number	l/min	l/sec	Rpm	Bar	LxWxH (mm)	KG	Air Fitting	Size	Max. Vibration EN-ISO 28927-9
Chisel hammer 12mm PRO	2809913401	648	10,8	3000	6,3	280 x 52 x 145	2,6	1/4"	12mm	23,01

Needle scaler 12 PRO



Light needle scaler for multiple scaling applications. Compact design for working in tight spaces. Easy-to-remove guide bush for rapid needle replacement, no tools required. Fatigue-free work thanks to low weight.

Model	Part Number	l/min	l/sec	Rpm	Bar	LxWxH (mm)	KG	Air Fitting	Size	Max. Vibration EN-ISO 28927-9
Needle scaler 12 PRO	2809913450	180	3	5000	6,3	320 x 40 x 62	1,3	1/4"	x12	9,84

Needle scaler 19 PRO



Universal needle scaler for scaling applications in construction & metalworking industries. Pistol grip for enhanced ergonomics. Adjustable needle guide to adapt to different applications. Rubber handle reduces vibrations.

Model	Part Number	l/min	l/sec	Rpm	Bar	LxWxH (mm)	KG	Air Fitting	Size	Max. Vibration EN-ISO 28927-9
Needle scaler 19 PRO	2809913451	180	3	3700	6,3	340 x 48 x 188	2,7	1/4"	x19	18,1

Needle scaler 28 PRO



Heavy duty needle scaler with durable stroke mechanism for professional use in the construction sector. Pistol grip for enhanced ergonomics. Adjustable needle guide to adapt to different applications. High impact power for hard materials.

Model	Part Number	l/min	l/sec	Rpm	Bar	LxWxH (mm)	KG	Air Fitting	Size	Max. Vibration EN-ISO 28927-9
Needle scaler 28 PRO	2809913452	288	4,8	3500	6,3	240 x 65 x 179	3,5	1/4"	x28	8,06

Saw Comp PRO



Compact air body saw with durable stroke mechanism. Effortless separation of body sheet metal and plastic parts. Low noise and vibrations thanks to robust plastic housing. Adjustable stop bracket offers easy handling and reduces saw blade wear.

Model	Part Number	l/min	l/sec	Rpm	Bar	LxWxH (mm)	KG	Air Fitting	Max. Vibration EN-ISO 28927-9
Saw Comp PRO	2809913700	240	4	9500	6,3	280 x 70 x 35	0,8	1/4"	3,7

Tire inflator PRO CEE QL



Robust tyre inflator for professional use. EC type approval. Fully rubber-coated body and manometer. Innovative "quick lock" valve adapter.

Model	Part Number	l/min	LxWxH (mm)	KG	Air Fitting	Max. work. pressure bar
Tire inflator PRO CEE QL	2809913620	0	245 x 95 x 125	0,94	1/4"	12

Tire inflator PRO CEE TR



Robust tyre inflator for professional use in truck workshops. EC type approval. Fully rubber-coated body and manometer. Double valve connector for trucks and buses.

Model	Part Number	l/min	LxWxH (mm)	KG	Air Fitting	Max. work. pressure bar
Tire inflator PRO CEE TR	2809913621	0	245 x 95 x 125	0,86	1/4"	12



Impact wrench Kit 1/2" G-101

Solid impact wrench for several DIY and semi professional applications such as tire changing on cars. Complete kit with accessories in plastic case. 4 different torque setting. Easy to handle forward/reverse switch.

Model	Part Number	l/min	l/sec	Rpm	Bar	LxWxH (mm)	KG	Air Fitting	Working Torque Nm	Square	Max. Vibration EN-ISO 28927-9
Impact wrench Kit 1/2" G-101	2809913105	240	4	7000	6,3	180 x 63 x 190	2,2	1/4"	345	1/2"	8,2



Impact wrench Kit 1/2" G-102

Robust impact wrench for several semi professional applications such as tire changing on cars and vans. Powerful twin-hammer impact system. Complete kit with accessories in plastic case. 6 different torque setting. Easy to handle forward/reverse switch.

Model	Part Number	l/min	l/sec	Rpm	Bar	LxWxH (mm)	KG	Air Fitting	Working Torque Nm	Square	Max. Vibration EN-ISO 28927-9
Impact wrench Kit 1/2" G-102	2809913106	143	2,4	7500	6,3	185 x 185 x 70	2,64	1/4"	500	1/2"	10,96



Ratchet wrench kit 1/2" G-150

Solid ratchet wrench for several semi professional screwing applications such as car repair. Complete kit with accessories in plastic case. Rubber handle cover isolates, reduces vibrations and provides more grip. Easy to handle forward/reverse switch on the ratchet head.

Model	Part Number	l/min	l/sec	Rpm	Bar	LxWxH (mm)	KG	Air Fitting	Working Torque Nm	Square	Max. Vibration EN-ISO 28927-9
Ratchet wrench kit 1/2" G-150	2809913153	77	1,3	160	6,3	238 x 41 x 55	1,2	1/4"	68	1/2"	0,8



Drill kit G-190

Reversible drill for several DIY and semi professional applications such drilling and screwing in different materials. Complete kit with accessories in plastic case. Rubber handle cover isolates, reduces vibrations and provides more grip. Keyless chuck.

Model	Part Number	l/min	l/sec	Rpm	Bar	LxWxH (mm)	KG	Air Fitting	Size	Max. Vibration EN-ISO 28927-9
Drill kit G-190	2809913191	106	1,8	1800	6,3	200 x 40 x 185	1,1	1/4"	10 mm	0,96



Die Grinder kit G-201

Compact Die grinder for several DIY and semi professional applications such as grinding and deburring. Complete kit with accessories in plastic case. Rubber handle cover isolates, reduces vibrations and provides more grip. Variable, can be used with 3 & 6mm shaft grinding stones.

Model	Part Number	l/min	l/sec	Rpm	Bar	LxWxH (mm)	KG	Air Fitting	Max. Vibration EN-ISO 28927-9
Die grinder kit G-201	2809913205	86	1,4	25000	6,3	172 x 40 x 30	0,5	1/4"	2,06



Angle grinder G-202

Compact angle grinder for several DIY and semi professional applications such as grinding, sanding and deburring. For use with 125mm grinding and cutting discs. Side handle for safe handling. Protection shield can be mounted in different positions to protect the user in best way.

Model	Part Number	l/min	l/sec	Rpm	Bar	LxWxH (mm)	KG	Air Fitting	Max. Vibration EN-ISO 28927-9
Angle grinder G-202	2809913206	138	2,3	10000	6,3	215 x 175 x 95	1,44	1/4"	4

Palm sander G-225



Compact orbital sander for several DIY and semi professional applications such as sanding fences, garden house or furniture. Quick work progres. Sanding pad with touch fastener for standard 125mm. Low dust formation. Rubber handle cover isolates, reduces vibrations and provides more grip.

Model	Part Number	l/min	l/sec	Rpm	Bar	LxWxH (mm)	KG	Air Fitting	Max. Vibration EN-ISO 28927-9
Palm sander G-225	2809913252	180	3	10500	6,3	202 x 125 x 111	0,92	1/4"	4,4

Orbital sander G-250



Compact orbital sander for several DIY and semi professional sanding applications, especial for large surfaces. Quick work progress due to the high revolution and 5mm stroke. Sanding pad with touch fastener for standard 150 mm without holes. Rubber handle cover isolates, reduces vibrations and provides more grip.

Model	Part Number	l/min	l/sec	Rpm	Bar	LxWxH (mm)	KG	Air Fitting
Orbital sander G-250	2809913253	120	2	10000	6,3	225 x 150 x 150	1,84	1/4"

Combi Nailer G-301



Combination nailer for several DIY and semi professional applications such as furniture production, flooring and modelling. Suitable for brad nails and staples. Adjustable impact depth. Safety use.

Model	Part Number	Bar	LxWxH (mm)	KG	Air Fitting	Staple/Nail (mm)	Staple width (mm)
Combi nailer G-301	2809913300	7-Apr	248 x 226 x 57	1,4	1/4"	15-32	5,7



Stapler G-302

Stapler for wide crown staples for several application such as fix foils at the ceil construction or leather and fabric at the furniture production. Suitable for staples with 12,8mm crown size. Compact and light weight design. Comfortable storing in a plastic box.

Model	Part Number	Bar	LxWxH (mm)	KG	Air Fitting	Staple/Nail (mm)	Staple width (mm)
Stapler G-302	2809913301	7-Apr	211 x 45 x 145	0,85	1/4"	16-Jun	12,8



Chisel Hammer G-425

Light weight chisel hammer for several DIY applications such as tiles and plaster removal. Complete kit with accessories in plastic case. Adaption of impact power. Rubber handle cover isolates, reduces the vibrations and provides more grip.

Model	Part Number	Rpm	Bar	LxWxH (mm)	KG	Air Fitting
Chisel hammer G-425	2809913402	4500	6,3	185 x 48 x 148	1,3	1/4"



Chisel Hammer G-475

Chisel hammer for several DIY and semi professional applications such as tiles and plaster removal. Complete kit with accessories in plastic case. Hexagonal chisel shaft. High impact power. Adaption of impact power. Rubber handle cover isolates, reduces the vibrations and provides more grip.

Model	Part Number	Rpm	Bar	LxWxH (mm)	KG	Air Fitting
Chisel hammer G-475	2809913403	4500	6,3	205 x 48 x 148	1,3	1/4"



Air Gun G-501

Standard air blowing gun for multiple application such as dedusting, drying and cleaning. Robust aluminium housing.

Model	Part Number	l/min	l/sec	Bar	LxWxH (mm)	KG	Air Fitting	Max. work. pressure bar	Nozzle Diameter mm
Air gun G-501	2809913500	125	2,1	0-8	125 x 18 x 170	0,2	1/4"	8	2



Air Gun G-502

Standard air blowing gun for DIY application such as dedusting and cleaning. Robust aluminium housing. Extension pipe.

Model	Part Number	l/min	l/sec	Bar	LxWxH (mm)	KG	Air Fitting	Max. work. pressure bar	Size	Nozzle Diameter mm
Air gun G-502	2809913501	125	2,1	0-8	210 x 18 x 170	0,28	1/4"	8	100 mm	2



Air Gun G-503

Light weight air blowing gun for multiple application such as dedusting, drying and cleaning. Light weight and isolating housing. Long nozzle.

Model	Part Number	l/min	l/sec	Bar	LxWxH (mm)	KG	Air Fitting	Max. work. pressure bar	Size	Nozzle Diameter mm
Air gun G-503	2809913502	125	2,1	0-8	127 x 20 x 260	0,15	1/4"	8	100 mm	3,8



Paint Spray Gun G-540F

Standard paint spray gun for DIY application such as painting fans, garden gate or furniture. Adjustable spray jet. Adjustable paint and air supply.

Model	Part Number	l/min	l/sec	Bar	LxWxH (mm)	KG	Air Fitting	Cup Capacity (l)	Max. work. pressure bar	Nozzle Diameter mm	Cup Size ml
Paint spray gun G-540F	2809913540	160	2,7	4-Feb	190 x 108 x 330	0,45	1/4"	0,5	4	1,5	600



Paint Spray Gun G-541A

Standard paint spray gun for DIY application such as painting fans, garden gate or furniture. 1l paint tank. Adjustable spray jet. Adjustable paint and air supply.

Model	Part Number	l/min	l/sec	Bar	LxWxH (mm)	KG	Air Fitting	Cup Capacity (l)	Max. work. pressure bar	Nozzle Diameter mm	Cup Size ml
Paint spray gun G-541A	2809913541	160	2,7	4-Feb	265 x 110 x 270	0,6	1/4"	1	4	1,5	1000



Paint Spray Gun G-542F

Mini paint spray gun for DIY application such as smart repair work or modelling. Adjustable spray jet. Adjustable paint and air supply.

Model	Part Number	l/min	l/sec	Bar	LxWxH (mm)	KG	Air Fitting	Cup Capacity (l)	Max. work. pressure bar	Nozzle Diameter mm	Cup Size ml
Paint spray gun G-542F	2809913543	57	1	3-Feb	125 x 90 x 230	0,2	1/4"	0,1	3	0,8	100



Paint Spray Gun G-550F

Semi-professional paint spray gun for application which requires a good finishing. Stainless steel nozzle. Smooth and wide spray jet. Adjustable parameter for different applications.

Model	Part Number	l/min	l/sec	Bar	LxWxH (mm)	KG	Air Fitting	Cup Capacity (l)	Max. work. pressure bar	Nozzle Diameter mm	Cup Size ml
Paint spray gun G-550F	2809913544	220	3,7	4-Feb	170 x 108 x 310	0,7	1/4"	0,6	4	1,5	600



Paint Spray Gun G-551A

Semi professional paint spray gun for application which requires a good finishing. 1l paint container. Stainless steel nozzle. Smooth and wide spray jet. Adjustable parameter for different applications.

Model	Part Number	l/min	l/sec	Bar	LxWxH (mm)	KG	Air Fitting	Cup Capacity (l)	Max. work. pressure bar	Nozzle Diameter mm	Cup Size ml
Paint spray gun G-551A	2809913545	220	3,7	3-Feb	190 x 275 x 110	0,7	1/4"	1	3	1,5	1000



Airbrush kit G-520

Standard paint spray gun for DIY application such as smart repair spraying and modelling. Adjustable paint flow. Air can adapter.

Model	Part Number	l/min	l/sec	Bar	LxWxH (mm)	KG	Air Fitting	Cup Capacity (l)	Max. work. pressure bar	Nozzle Diameter mm	Cup Size ml
Airbrush kit G-520	2809913542	15	0,25	0-2	180 x 52 x 110	0,3	1/4"	0,02	2	0,5	22

Washing Gun G-530



Spraying gun for different application such as cleaning, oiling, decreasing and garden application. Adjustable spray jet. 900ml aluminium tank.

Model	Part Number	l/min	l/sec	Bar	LxWxH (mm)	KG	Air Fitting	Cup Capacity (l)	Max. work. pressure bar	Size	Nozzle Diameter mm	Cup Size ml
Spray gun G-530	2809913570	130	2,2	8-Apr	160 x 105 x 400	0,6	1/4"	0,9	8	200 mm	4,5	900



Wax & Undercoat Spray Gun G-531

Spraying gun for car application such as anti noise treatment or body-cavity seal. Suitable for standard 1l cans with 40mm thread. Injection probe with four side spray orifice for use in tighten places of car body. Multi purpose spray gun.

Model	Part Number	l/min	l/sec	Bar	LxWxH (mm)	KG	Air Fitting	Max. work. pressure bar	Nozzle Diameter mm
Spray gun G-531	2809913571	130	2,2	5-Feb	170 x 60 x 280	0,5	1/4"	5	6

Watering Gun G-532



Watering gun for DIY application such as car or bike cleaning and garden application. Pressurized water flow. Adjustable spray jet. 13mm standard garden hose connection.

Model	Part Number	l/min	l/sec	Bar	LxWxH (mm)	KG	Air Fitting	Nozzle Diameter mm
Watering gun G-532	2809913572	120	2	4	280 x 30 x 200	0,5	1/4"	6



Plaster spray gun G-534

Plaster spray gun for renovation work. Universal use due to the different nozzle diameter (4, 6, 8 mm). Easy to handle.

Model	Part Number	l/min	l/sec	Bar	LxWxH (mm)	KG	Air Fitting	Cup Capacity (l)	Nozzle Diameter mm	Cup Size ml
Plaster spray gun G-534	2809913573	250	4,2	8	234 x 280 x 454	1,2	1/4"	4,5	4-8mm	4500



Sand blasting gun G-560A

Standard sand blasting gun for DIY application such as rust and paint removal. 6mm nozzle for use of standard abrasive agent with grid size 0,2-0,8mm. Light and compact design.

Model	Part Number	l/min	l/sec	Bar	LxWxH (mm)	KG	Air Fitting	Nozzle Diameter mm
Sand blasting gun G-560A	2809913580	160	2,7	8	145 x 118 x 265	1	1/4"	6



Sand blasting gun G-561H

Standard sand blasting gun for DIY application such as rust and paint removal. 6mm nozzle for use of standard abrasive agent with grid size 0,2-0,8mm. Suitable for big surfaces.

Model	Part Number	l/min	l/sec	Bar	LxWxH (mm)	KG	Air Fitting	Size
Sand blasting gun G-561H	2809913581	60	1	3	210 x 25 x 170	0,8	1/4"	310 ml

Cartridge gun G-570



Cartridge gun for standard 310ml plastic cartridges. Multiple use can be used for silicon and adhesives. Quick pressure release by pushing the venting valve. Fast and easy sealing without manual efforts.

Model	Part Number	LxWxH (mm)	KG	Air Fitting
Cartridge gun G-570	2809913600	302 x 163 x 61	0,8	1/4"

Tire inflator G-580



Standard tire inflator for DIY application such as inflating of car & bike tires, balls and dinghies. 3 pcs adapter kit. Manometer scale in bar and PS.

Model	Part Number	Bar	LxWxH (mm)	KG	Air Fitting	Max. work. pressure bar
Tire inflator G-580	2809913622	0-8	138 x 33 x 230	0,3	1/4"	8

Multi-use Kit 8-piece G-810AL



Tool Kit for several DIY applications such as:

Inflating of car & bike tires, balls and dinghies, Painting, Washing or sanitizing, Dust removal, Suitable for use with smaller compressors.

Model	Part Number	Air Fitting	Nozzle Diameter mm	Cup Size ml
kit 8pcs G-810AL	2809913650	1/4"	1,5	1000



Multi-use Kit 5-piece G-811TI

Tire inflator kit for several DIY applications such as inflating of car & bike tires, balls and dinghies. Suitable for use with smaller compressors.

Model	Part Number	Air Fitting
Kit 5pcs G-811TI	2809913651	1/4"



Multi-use Kit 5-piece G-812IG

Inflator kit for several DIY applications such as:

Inflating of car & bike tires, balls and dinghies. Inflator gun with rigid pipe especial suitable for use with adapter kits. Suitable for use with smaller compressors.

Model	Part Number	Air Fitting
kit 5pcs G-812IG	2809913652	1/4"



Multi-use Kit 6-piece G-813

Tool Kit for several DIY applications such as:

Inflating of car & bike tires, balls and dinghies. Dust removal. Suitable for use with smaller compressors.

Model	Part Number	Air Fitting
kit 6pcs G-813	2809913653	1/4"



Multi-use Kit 8-piece G-810P

Tool Kit for several DIY applications such as:

Inflating of car & bike tires, balls and dinghies. Painting. Washing or sanitizing. Dust removal. Suitable for use with smaller compressors.

Model	Part Number	Air Fitting	Nozzle Diameter mm	Cup Size ml	CE Declaration
kit 8pcs G-810P	2809913655	1/4"	2	600	
kit 8pcs G-810P (Homologated Inflating Gun)	2809913656	1/4"	2	600	CE inflator



Multi-use Kit 8-piece G-810AL-BL

Tool Kit for several DIY applications such as:

Inflating of car & bike tires, balls and dinghies. Painting. Washing or sanitizing. Dust removal. Suitable for use with smaller compressors.

Model	Part Number	Air Fitting	Nozzle Diameter mm	Cup Size ml
kit 8pcs G-810AL-BL	2809913657	1/4"	2	1000



Tool kit 49-piece G-850

49pcs Tool Kit including:

Impact wrench+ Sockets. Chisel hammer + Chisels. Ratchet wrench. Blow gun. And accessories.

Model	Part Number	Bar	Air Fitting	Working Torque Nm	Max. Vibration EN-ISO 28927-9
Tool kit 49pcs G-850	2809913658	6,3	1/4"	345	2,8



Tool kit 71-piece G-852

71pcs Tool Kit including:

Impact wrench+ Sockets. Chisel hammer + Chisels. Die Grinder + Grinding stones. Ratchet wrench. Blow Gun. And accessories.

Model	Part Number	Bar	Air Fitting	Working Torque Nm	Max. Vibration EN-ISO 28927-9
Tool kit 71pcs G-852	2809913660	6,3	1/4"	345	9,5



Greasing Gun G-911

Greasing gun for different maintenance application on cars and trucks, agriculture and on production lines. Universal use thanks to adaption to popular 6mm greasing nipple standard. 3 different ways of loading. Greasing gun can be used with standard 400ml grease cartridges or loaded manually or with filler pump. Fast and easy greasing without manual efforts.

Model	Part Number	Bar	LxWxH (mm)	KG	Air Fitting	Size
Greasing gun G-911	2809913701	6,3	410 x 60 x 155	1,6	1/4"	82 mm

Accessories



Accessories

To ensure a faultless delivery of air from the compressor to your final application, you can trust ABAC fittings and point-of-use accessories to do the job.

Professional

A large selection of high-performance fittings and accessories to suit many applications.

136

DIY & Hobby

To complete your ABAC workshop installation, we offer a range of spare parts and complementary products for our pneumatic tools.

139



Robust sockets with protection for tyre changing

Hardened steel. Protective plastic cover. Long design.

Model	Part Number	Size
1/2" SOCKETS NON-SCRATCH	2809919100	17, 19, 21mm



Magnetic tool holder

2 strong magnets. Space for 4pcs sockets, 1/2" impact wrench. Hook for torque wrench.

Model	Part Number
WALL BRACKET F. 1/2"IMP WRENCH	2809919101

Spare Sanding Belts

Sanding belt 330x10 mm. 5 pieces per pack.



Model	Part Number	Type
SANDING BELTS 330-10/5PC G80	2809919250	80 Grit
SANDING BELTS 330-10/5PC G120	2809919251	120 Grit

Spare Sanding Pad



Sanding Pad suitable for 15-hole, 8-hole and 6-hole sanding paper.

Model	Part Number	Size
SANDING PAD 150MM	2809919252	150mm

Spare Chisels



Spare Chisels for Chisel hammer 12 mm PRO.

Model	Part Number
Pointed Chisel 250-14-11,7	2809919400
Flat Chisel 250-20-11,7	2809919401

Spare Needle Kit



Hardened steel. 3 mm diameter.

Model	Part Number	Type
Needle kit 12/3mm	2809919450	12 needle
Needle kit 19/3mm	2809919451	19 needle
Needle kit 28/3mm	2809919452	28 needle



Spare Saw Blades

Bi-metal version. 5 pieces per pack.

Model	Part Number	Size
SAW BLADES 0,3-0,8MM 5PC	2809919700	0,3-0,8mm
SAW BLADES 0,8-1,2MM 5PC	2809919701	0,8-1,2mm

Hose Reel



Automatic hose reel for comfortable use of pneumatic tools. Safe working area, no trip hazard caused by pneumatic hoses on the floor. Wide working radius, thanks to 180° rotatable housing. Comfortable use due to stop interval of 50 cm, the hose is not under tension and just the needed length can be pulled out.

Model	Part Number	Bar	LxWxH (mm)	KG	Air Fitting	Max. work. pressure bar	Size	Dimensions of inlet and outlet connections
Hose Reel G-6/10 10M Auto	2809913800	0-11	300 x 250 x 150	3,2	1/4"	11	6x10 mm x 10 m	EURO
Hose Reel G-8/12 9M Auto	2809913801	0-11	360 x 280 x 150	3,3	1/4"	11	8x12 mm x 9 m	EURO



Oil Injected Screw Air Compressors

Air. Anytime. Anywhere.

How to choose your screw compressor

Selecting the correct air compressor for your requirements is an important business consideration, ABAC is here to assist you in choosing the right one.

The first stage in the process is to identify the correct size of air compressor, which is determined by your intended application and usage. The compressor size is measured by the rate of air flow and the pressure delivered by the compressor, which needs to be adequate to perform the specific tasks involved.

The best way to find out the total amount of flow needed is to contact ABAC and request data sheets with the required information, or we can help you arrange an audit from an air sales professional.

The second stage of the selection process relates to choosing the correct type of compressor. It is also important to choose the technology which best suits your application.



Checklist

- What is the application?
- How much flow does my facility/workshop use?
- What pressure is needed within the facility?
- Do I need clean/dry air (use of dryer and filters)?
- How many hours per year does my compressor operate?
- Is there fluctuation in flow demand between shifts?
- Are there any plans for future expansion?

If your application requires constant compressed air supply, you should consider a rotary screw air compressor.

They can be used for any operations that require up to a 100% continuous duty cycle and are built for long lifetime of reliable operation.

There are various available, depending on your needs and budget. One of those options is the ability to integrate a dryer into the package, which is ideal for the applications that require clean and dry air. Smaller screw compressors can also be tank mounted allowing for additional storage capacity which, coupled with an integrated dryer, allows for plug and play installation. This makes it ideal if you have limited space at your facility and if you want to save on installation costs.

Depending on your budget, there is a screw compressor for everyone, ranging from basic design, usually available on smaller kW/HP ranges, all the way to Variable Speed (Frequency) Drive (VSD) units. Those are more expensive but typically make up for the initial cost with energy savings.

FIXED SPEED

- ▶ Ideal in applications when the compressed air demand is constant
- ▶ The machine will run at the same engine speed at all times, unless it is switched off
- ▶ They are most efficient in applications with consistent compressed air demands, not ones that might have peaks and troughs



FORMULA M Fix speed



SPEED

VARIABLE SPEED

- ▶ match the output to the demand that is needed and can sense how much flow is being used, while adjusting its speed accordingly.
- ▶ as the need for air increases, so does the speed of the motor, therefore supplying more flow / CFM
- ▶ if the demand decreases, the motor will automatically slow down and only use the required energy to provide appropriate flow
- ▶ especially handy, as it eliminates the waste of electricity, therefore saving money, when multiple demand fluctuation throughout the day



FORMULA MI Variable speed



SPEED

Oil-Injected Screw Compressors Fixed Speed



Oil-Injected Screw Compressors Fixed Speed

Fixed Speed (FS) air compressor operates at the same speed whenever it's running. By design, it always draws the amount of power needed to meet the maximum compressed air. Fixed Speed is ideal solution demand for compressed air that fluctuates little.

SPINN D2.2 kW

Spinn 2.2DDkW is a compact and silent compressor ideal for adverse places and provides the highest flow.

147

SPINN 2.2-7.5 kW

ABAC has developed a compact screw compressor with significantly lower noise levels, allowing you to install it close to the point of use. Easy to use, high performance levels and simple to maintain: the SPINN is ideal for a wide variety of configurations.

148

SPINN 5.5x-15 kW

ABAC Spinn is a small screw compressor with extremely low noise levels, comparable to your air conditioning system. Compact and easy to install, it can offer excellent savings on installation and piping costs.

153

SPINN 15x-22 kW

Responding to the needs of all industries, Spinn 15x-22 kW continues to innovate its range of compressed air solutions. With a particular focus on energy efficiency, whilst always improving performance and reliability, our latest generation of rotary screw compressors delivers a reduced total cost of ownership.

155

FORMULA FS 5.5-11 kW

FORMULA Fix Speed to fit your business needs. Many different versions, power sizes, voltages, pressure variants, efficiencies and market approvals are available for service, assembly, or any other industrial application.

157

FORMULA FS 15-22 kW

FORMULA Fix Speed to fit your business needs. Many different versions, power sizes, voltages, pressure variants, efficiencies and market approvals are available for service, assembly, or any other industrial application.

158

FORMULA FS 30-45 kW

FORMULA M Gear Driven Fix speed will grant top performances. Easy to use, reliable, efficient: FORMULA M is simply about that. Evolved to tackle the toughest industrial jobs, this air compressor results in cost savings and high performances.

159

FORMULA FS 30-45 13B kW

FORMULA M Gear Driven Fix speed will grant top performances. Easy to use, reliable, efficient: FORMULA M is simply about that. Evolved to tackle the toughest industrial jobs, this air compressor results in cost savings and high performances.

160

FORMULA FS 55-75 kW

FORMULA M 55-75 kW fixed-speed screw compressors provide an experience of exceptional performance and reliability. With advanced connectivity and intuitive controls, these compressors bring intelligence, ease of use, and valuable insights to your operations. By harnessing these features, you can effectively reduce operating costs and boost productivity, all while tailoring the compressor to your specific situation and needs.

161

GENESIS FS 5.5-11 kW

Genesis Fix Speed workstation is a unique integrated solution, efficiencies and market approvals are available for service, assembly, or any other industrial application.

162

GENESIS FS 15-22 kW

Genesis Fix Speed workstation is a unique integrated solution, efficiencies and market approvals are available for service, assembly, or any other industrial application.

163



SPINN D2.2 kW Tank Mounted

New technology with fully integrated aluminum block and direct driven transmission. Compact and silent compressor ideal for adverse places and provides the highest flow capacity.

Model	Part Number	Configuration	l/min	L	HP	kW	Voltz	Bar	dB(A)	LxWxH (mm)	KG
SPINN D2.2 90W 10 MEAA 230/50	4152044020	TM	272	90	3	2,2	230/1/50	10	59	1105 x 495 x 1085	112
SPINN D2.2 200W 10 MEAA 230/50	4152044021	TM	272	200	3	2,2	230/1/50	10	59	1430 x 616 x 1268	160
SPINN D2.2 200 10 MEAA 230/50	4152044022	TM	272	200	3	2,2	230/1/50	10	59	1430 x 450 x 1268	112
SPINN D2.2 90W 10 MEAA 400/50	4152044023	TM	272	90	3	2,2	400/3/50	10	59	1105 x 495 x 1085	110
SPINN D2.2 200W 10 MEAA 400/50	4152044024	TM	272	200	3	2,2	400/3/50	10	59	1430 x 616 x 1268	157
SPINN D2.2 200 10 MEAA 400/50	4152044025	TM	272	200	3	2,2	400/3/50	10	59	1430 x 450 x 1268	110



SPINN 2.2-7.5 kW Base Mounted

Base Mounted

Model	Part Number	Configuration	l/min	L	HP	kW	Voltz	Bar	dB(A)	LxWxH (mm)	KG
SPINN2,2 8 400/50K E CE	4152054944	BM	366	0	3	2,2	400/3/50	8	61	620 x 630 x 950	110
SPINN2,2 10 400/50K E CE	4152054945	BM	294	0	3	2,2	400/3/50	10	61	620 x 630 x 950	110
SPINN3 8 400/50K E CE	4152054954	BM	474	0	4	3	400/3/50	8	61	620 x 630 x 950	115
SPINN3 10 400/50K E CE	4152054955	BM	366	0	4	3	400/3/50	10	61	620 x 630 x 950	115
SPINN4 8 400/50K E CE	4152054964	BM	600	0	5,5	4	400/3/50	8	62	620 x 630 x 950	120
SPINN4 10 400/50K E CE	4152054965	BM	516	0	5,5	4	400/3/50	10	62	620 x 630 x 950	120
SPINN4 8 400/50 E CE	4152054974	BM	600	0	5,5	4	400/3/50	8	62	620 x 630 x 950	120
SPINN4 10 400/50 E CE	4152054975	BM	516	0	5,5	4	400/3/50	10	62	620 x 630 x 950	120
SPINN5,5 8 400/50 E CE	4152054984	BM	888	0	7,5	5,5	400/3/50	8	66	620 x 630 x 950	130
SPINN5,5 10 400/50 E CE	4152054985	BM	780	0	7,5	5,5	400/3/50	10	66	620 x 630 x 950	130
SPINN7,5 8 400/50 E CE	4152054994	BM	1062	0	10	7,5	400/3/50	8	68	620 x 665 x 950	140
SPINN7,5 10 400/50 E CE	4152054995	BM	984	0	10	7,5	400/3/50	10	68	620 x 665 x 950	140



SPINN 2.2-7.5 kW Base Mounted - Controller

Base Mounted

Model	Part Number	Configuration	l/min	L	HP	kW	Voltz	Bar	dB(A)	LxWxH (mm)	KG
SPINN2,2 8 400/50K C CE	4152051944	BM	366	0	3	2,2	400/3/50	8	61	620 x 630 x 950	110
SPINN2,2 10 400/50K C CE	4152051945	BM	294	0	3	2,2	400/3/50	10	61	620 x 630 x 950	110
SPINN3 8 400/50K C CE	4152051954	BM	474	0	4	3	400/3/50	8	61	620 x 630 x 950	115
SPINN3 10 400/50K C CE	4152051955	BM	366	0	4	3	400/3/50	10	61	620 x 630 x 950	115
SPINN4 8 400/50K C CE	4152051964	BM	600	0	5,5	4	400/3/50	8	62	620 x 630 x 950	120
SPINN4 10 400/50K C CE	4152051965	BM	516	0	5,5	4	400/3/50	10	62	620 x 630 x 950	120
SPINN4 8 400/50 C CE	4152051974	BM	600	0	5,5	4	400/3/50	8	62	620 x 630 x 950	120
SPINN4 10 400/50 C CE	4152051975	BM	516	0	5,5	4	400/3/50	10	62	620 x 630 x 950	120
SPINN5,5 8 400/50 C CE	4152051984	BM	888	0	7,5	5,5	400/3/50	8	66	620 x 630 x 950	130
SPINN5,5 10 400/50 C CE	4152051985	BM	780	0	7,5	5,5	400/3/50	10	66	620 x 630 x 950	130
SPINN7,5 8 400/50 C CE	4152051994	BM	1062	0	10	7,5	400/3/50	8	68	620 x 665 x 950	140
SPINN7,5 10 400/50 C CE	4152051995	BM	984	0	10	7,5	400/3/50	10	68	620 x 665 x 950	140



SPINN 2.2-7.5 kW Tank Mounted

Tank Mounted

Model	Part Number	Configuration	l/min	L	HP	kW	Voltz	Bar	dB(A)	LxWxH (mm)	KG
SPINN2,2 8 400/50K 200 E CE	4152054946	TM	366	200	3	2,2	400/3/50	8	61	1430 x 600 x 1260	165
SPINN2,2 10 400/50K 200 E CE	4152054947	TM	294	200	3	2,2	400/3/50	10	61	1430 x 600 x 1260	165
SPINN2,2 8 400/50K 270 E CE	4152054948	TM	366	270	3	2,2	400/3/50	8	61	1540 x 600 x 1350	180
SPINN2,2 10 400/50K 270 E CE	4152054949	TM	294	270	3	2,2	400/3/50	10	61	1540 x 600 x 1350	180
SPINN3 8 400/50K 200 E CE	4152054956	TM	474	200	4	3	400/3/50	8	61	1430 x 600 x 1260	170
SPINN3 10 400/50K 200 E CE	4152054957	TM	366	200	4	3	400/3/50	10	61	1430 x 600 x 1260	170
SPINN3 8 400/50K 270 E CE	4152054958	TM	474	270	4	3	400/3/50	8	61	1540 x 600 x 1350	185
SPINN3 10 400/50K 270 E CE	4152054959	TM	366	270	4	3	400/3/50	10	61	1540 x 600 x 1350	185
SPINN4 8 400/50K 200 E CE	4152054966	TM	600	200	5,5	4	400/3/50	8	62	1430 x 600 x 1260	175
SPINN4 10 400/50K 200 E CE	4152054967	TM	516	200	5,5	4	400/3/50	10	62	1430 x 600 x 1260	175
SPINN4 8 400/50K 270 E CE	4152054968	TM	600	270	5,5	4	400/3/50	8	62	1540 x 600 x 1350	190
SPINN4 10 400/50K 270 E CE	4152054969	TM	516	270	5,5	4	400/3/50	10	62	1540 x 600 x 1350	190
SPINN4 8 400/50 200 E CE	4152054976	TM	600	200	5,5	4	400/3/50	8	62	1430 x 600 x 1260	175
SPINN4 10 400/50 200 E CE	4152054977	TM	516	200	5,5	4	400/3/50	10	62	1430 x 600 x 1260	175
SPINN4 8 400/50 270 E CE	4152054978	TM	600	270	5,5	4	400/3/50	8	62	1540 x 600 x 1350	190
SPINN4 10 400/50 270 E CE	4152054979	TM	516	270	5,5	4	400/3/50	10	62	1540 x 600 x 1350	190
SPINN5,5 8 400/50 200 E CE	4152054986	TM	888	200	7,5	5,5	400/3/50	8	66	1430 x 600 x 1260	185
SPINN5,5 10 400/50 200 E CE	4152054987	TM	780	200	7,5	5,5	400/3/50	10	66	1430 x 600 x 1260	185
SPINN5,5 8 400/50 270 E CE	4152054988	TM	888	270	7,5	5,5	400/3/50	8	66	1540 x 600 x 1350	200
SPINN5,5 10 400/50 270 E CE	4152054989	TM	780	270	7,5	5,5	400/3/50	10	66	1540 x 600 x 1350	200
SPINN7,5 8 400/50 200 E CE	4152054996	TM	1062	200	10	7,5	400/3/50	8	68	1430 x 665 x 1260	195
SPINN7,5 10 400/50 200 E CE	4152054997	TM	984	200	10	7,5	400/3/50	10	68	1430 x 665 x 1260	195
SPINN7,5 8 400/50 270 E CE	4152054998	TM	1062	270	10	7,5	400/3/50	8	68	1540 x 665 x 1350	210
SPINN7,5 10 400/50 270 E CE	4152054999	TM	984	270	10	7,5	400/3/50	10	68	1540 x 665 x 1350	210



SPINN 2.2-7.5 kW Tank Mounted Dryer

Tank Mounted Dryer

Model	Part Number	Configuration	l/min	L	HP	kW	Voltz	Bar	dB(A)	LxWxH (mm)	KG	Dryer
SPINN2,2E 8 400/50K 200 E CE	4152054950	TMD	366	200	3	2,2	400/3/50	8	61	1430 x 600 x 1260	190	Yes
SPINN2,2E 10 400/50K 200 E CE	4152054951	TMD	294	200	3	2,2	400/3/50	10	61	1430 x 600 x 1260	190	Yes
SPINN2,2E 8 400/50K 270 E CE	4152054952	TMD	366	270	3	2,2	400/3/50	8	61	1540 x 600 x 1350	205	Yes
SPINN2,2E 10 400/50K 270 E CE	4152054953	TMD	294	270	3	2,2	400/3/50	10	61	1540 x 600 x 1350	205	Yes
SPINN3E 8 400/50K 200 E CE	4152054960	TMD	474	200	4	3	400/3/50	8	61	1430 x 600 x 1260	195	Yes
SPINN3E 10 400/50K 200 E CE	4152054961	TMD	366	200	4	3	400/3/50	10	61	1430 x 600 x 1260	195	Yes
SPINN3E 8 400/50K 270 E CE	4152054962	TMD	474	270	4	3	400/3/50	8	61	1540 x 600 x 1350	210	Yes
SPINN3E 10 400/50K 270 E CE	4152054963	TMD	366	270	4	3	400/3/50	10	61	1540 x 600 x 1350	210	Yes
SPINN4E 8 400/50K 200 E CE	4152054970	TMD	600	200	5,5	4	400/3/50	8	62	1430 x 600 x 1260	200	Yes
SPINN4E 10 400/50K 200 E CE	4152054971	TMD	516	200	5,5	4	400/3/50	10	62	1430 x 600 x 1260	200	Yes
SPINN4E 8 400/50K 270 E CE	4152054972	TMD	600	270	5,5	4	400/3/50	8	62	1540 x 600 x 1350	215	Yes
SPINN4E 10 400/50K 270 E CE	4152054973	TMD	516	270	5,5	4	400/3/50	10	62	1540 x 600 x 1350	215	Yes
SPINN4E 8 400/50 200 E CE	4152054980	TMD	600	200	5,5	4	400/3/50	8	62	1430 x 600 x 1260	200	Yes
SPINN4E 10 400/50 200 E CE	4152054981	TMD	516	200	5,5	4	400/3/50	10	62	1430 x 600 x 1260	200	Yes
SPINN4E 8 400/50 270 E CE	4152054982	TMD	600	270	5,5	4	400/3/50	8	62	1540 x 600 x 1350	215	Yes
SPINN4E 10 400/50 270 E CE	4152054983	TMD	516	270	5,5	4	400/3/50	10	62	1540 x 600 x 1350	215	Yes
SPINN5,5E 8 400/50 200 E CE	4152054990	TMD	888	200	7,5	5,5	400/3/50	8	66	1430 x 600 x 1260	210	Yes
SPINN5,5E 10 400/50 200 E CE	4152054991	TMD	780	200	7,5	5,5	400/3/50	10	66	1430 x 600 x 1260	210	Yes
SPINN5,5E 8 400/50 270 E CE	4152054992	TMD	888	270	7,5	5,5	400/3/50	8	66	1540 x 600 x 1350	225	Yes
SPINN5,5E 10 400/50 270 E CE	4152054993	TMD	780	270	7,5	5,5	400/3/50	10	66	1540 x 600 x 1350	225	Yes
SPINN7,5E 8 400/50 200 E CE	4152055000	TMD	1062	200	10	7,5	400/3/50	8	68	1430 x 665 x 1260	225	Yes
SPINN7,5E 10 400/50 200 E CE	4152055001	TMD	984	200	10	7,5	400/3/50	10	68	1430 x 665 x 1260	225	Yes
SPINN7,5E 8 400/50 270 E CE	4152055002	TMD	1062	270	10	7,5	400/3/50	8	68	1540 x 665 x 1350	240	Yes
SPINN7,5E 10 400/50 270 E CE	4152055003	TMD	984	270	10	7,5	400/3/50	10	68	1540 x 665 x 1350	240	Yes



SPINN 2.2-7.5 kW Tank Mounted - Controller

Tank Mounted

Model	Part Number	Configuration	l/min	L	HP	KW	Voltz	Bar	dB(A)	LxWxH (mm)	KG
SPINN2,2 8 400/50K 200 C CE	4152051946	TM	366	200	3	2,2	400/3/50	8	61	1430 x 600 x 1260	165
SPINN2,2 10 400/50K 200 C CE	4152051947	TM	294	200	3	2,2	400/3/50	10	61	1430 x 600 x 1260	165
SPINN2,2 8 400/50K 270 C CE	4152051948	TM	366	270	3	2,2	400/3/50	8	61	1540 x 600 x 1350	180
SPINN2,2 10 400/50K 270 C CE	4152051949	TM	294	270	3	2,2	400/3/50	10	61	1540 x 600 x 1350	180
SPINN3 8 400/50K 200 C CE	4152051956	TM	474	200	4	3	400/3/50	8	61	1430 x 600 x 1260	170
SPINN3 10 400/50K 200 C CE	4152051957	TM	366	200	4	3	400/3/50	10	61	1430 x 600 x 1260	170
SPINN3 8 400/50K 270 C CE	4152051958	TM	474	270	4	3	400/3/50	8	61	1540 x 600 x 1350	185
SPINN3 10 400/50K 270 C CE	4152051959	TM	366	270	4	3	400/3/50	10	61	1540 x 600 x 1350	185
SPINN4 8 400/50K 200 C CE	4152051966	TM	600	200	5,5	4	400/3/50	8	62	1430 x 600 x 1260	175
SPINN4 10 400/50K 200 C CE	4152051967	TM	516	200	5,5	4	400/3/50	10	62	1430 x 600 x 1260	175
SPINN4 8 400/50K 270 C CE	4152051968	TM	600	270	5,5	4	400/3/50	8	62	1540 x 600 x 1350	190
SPINN4 10 400/50K 270 C CE	4152051969	TM	516	270	5,5	4	400/3/50	10	62	1540 x 600 x 1350	190
SPINN4 8 400/50 200 C CE	4152051976	TM	600	200	5,5	4	400/3/50	8	62	1430 x 600 x 1260	175
SPINN4 10 400/50 200 C CE	4152051977	TM	516	200	5,5	4	400/3/50	10	62	1430 x 600 x 1260	175
SPINN4 8 400/50 270 C CE	4152051978	TM	600	270	5,5	4	400/3/50	8	62	1540 x 600 x 1350	190
SPINN4 10 400/50 270 C CE	4152051979	TM	516	270	5,5	4	400/3/50	10	62	1540 x 600 x 1350	190
SPINN5,5 8 400/50 200 C CE	4152051986	TM	888	200	7,5	5,5	400/3/50	8	66	1430 x 600 x 1260	185
SPINN5,5 10 400/50 200 C CE	4152051987	TM	780	200	7,5	5,5	400/3/50	10	66	1430 x 600 x 1260	185
SPINN5,5 8 400/50 270 C CE	4152051988	TM	888	270	7,5	5,5	400/3/50	8	66	1540 x 600 x 1350	200
SPINN5,5 10 400/50 270 C CE	4152051989	TM	780	270	7,5	5,5	400/3/50	10	66	1540 x 600 x 1350	200
SPINN7,5 8 400/50 200 C CE	4152051996	TM	1062	200	10	7,5	400/3/50	8	68	1430 x 665 x 1260	195
SPINN7,5 10 400/50 200 C CE	4152051997	TM	984	200	10	7,5	400/3/50	10	68	1430 x 665 x 1260	195
SPINN7,5 8 400/50 270 C CE	4152051998	TM	1062	270	10	7,5	400/3/50	8	68	1540 x 665 x 1350	210
SPINN7,5 10 400/50 270 C CE	4152051999	TM	984	270	10	7,5	400/3/50	10	68	1540 x 665 x 1350	210



SPINN 2.2-7.5 kW Tank Mounted Dryer - Controller

Tank Mounted Dryer

Model	Part Number	Configuration	l/min	L	HP	kW	Voltz	Bar	dB(A)	LxWxH (mm)	KG	Dryer
SPINN2,2E 8 400/50K 200 C CE	4152051950	TMD	366	200	3	2,2	400/3/50	8	61	1430 x 600 x 1260	190	Yes
SPINN2,2E 10 400/50K 200 C CE	4152051951	TMD	294	200	3	2,2	400/3/50	10	61	1430 x 600 x 1260	190	Yes
SPINN2,2E 8 400/50K 270 C CE	4152051952	TMD	366	270	3	2,2	400/3/50	8	61	1540 x 600 x 1350	205	Yes
SPINN2,2E 10 400/50K 270 C CE	4152051953	TMD	294	270	3	2,2	400/3/50	10	61	1540 x 600 x 1350	205	Yes
SPINN3E 8 400/50K 200 C CE	4152051960	TMD	474	200	4	3	400/3/50	8	61	1430 x 600 x 1260	195	Yes
SPINN3E 10 400/50K 200 C CE	4152051961	TMD	366	200	4	3	400/3/50	10	61	1430 x 600 x 1260	195	Yes
SPINN3E 8 400/50K 270 C CE	4152051962	TMD	474	270	4	3	400/3/50	8	61	1540 x 600 x 1350	210	Yes
SPINN3E 10 400/50K 270 C CE	4152051963	TMD	366	270	4	3	400/3/50	10	61	1540 x 600 x 1350	210	Yes
SPINN4E 8 400/50K 200 C CE	4152051970	TMD	600	200	5,5	4	400/3/50	8	62	1430 x 600 x 1260	200	Yes
SPINN4E 10 400/50K 200 C CE	4152051971	TMD	516	200	5,5	4	400/3/50	10	62	1430 x 600 x 1260	200	Yes
SPINN4E 8 400/50K 270 C CE	4152051972	TMD	600	270	5,5	4	400/3/50	8	62	1540 x 600 x 1350	215	Yes
SPINN4E 10 400/50K 270 C CE	4152051973	TMD	516	270	5,5	4	400/3/50	10	62	1540 x 600 x 1350	215	Yes
SPINN4E 8 400/50 200 C CE	4152051980	TMD	600	200	5,5	4	400/3/50	8	62	1430 x 600 x 1260	200	Yes
SPINN4E 10 400/50 200 C CE	4152051981	TMD	516	200	5,5	4	400/3/50	10	62	1430 x 600 x 1260	200	Yes
SPINN4E 8 400/50 270 C CE	4152051982	TMD	600	270	5,5	4	400/3/50	8	62	1540 x 600 x 1350	215	Yes
SPINN4E 10 400/50 270 C CE	4152051983	TMD	516	270	5,5	4	400/3/50	10	62	1540 x 600 x 1350	215	Yes
SPINN5,5E 8 400/50 200 C CE	4152051990	TMD	888	200	7,5	5,5	400/3/50	8	66	1430 x 600 x 1260	210	Yes
SPINN5,5E 10 400/50 200 C CE	4152051991	TMD	780	200	7,5	5,5	400/3/50	10	66	1430 x 600 x 1260	210	Yes
SPINN5,5E 8 400/50 270 C CE	4152051992	TMD	888	270	7,5	5,5	400/3/50	8	66	1540 x 600 x 1350	225	Yes
SPINN5,5E 10 400/50 270 C CE	4152051993	TMD	780	270	7,5	5,5	400/3/50	10	66	1540 x 600 x 1350	225	Yes
SPINN7,5E 8 400/50 200 C CE	4152052000	TMD	1062	200	10	7,5	400/3/50	8	68	1430 x 665 x 1260	225	Yes
SPINN7,5E 10 400/50 200 C CE	4152052001	TMD	984	200	10	7,5	400/3/50	10	68	1430 x 665 x 1260	225	Yes
SPINN7,5E 8 400/50 270 C CE	4152052002	TMD	1062	270	10	7,5	400/3/50	8	68	1540 x 665 x 1350	240	Yes
SPINN7,5E 10 400/50 270 C CE	4152052003	TMD	984	270	10	7,5	400/3/50	10	68	1540 x 665 x 1350	240	Yes



SPINN 5.5x-15 kW Base Mounted

Base Mounted

Model	Part Number	Configuration	l/min	L	HP	kW	Voltz	Bar	dB(A)	LxWxH (mm)	KG
SPINN 5.5X 8 400/50 FM CE	4152022537	BM	846	0	7,5	5,5	400/3/50	8	64	850 x 720 x 980	172
SPINN 5.5X 10 400/50 FM CE	4152022538	BM	696	0	7,5	5,5	400/3/50	10	64	850 x 720 x 980	172
SPINN 7.5X 8 400/50 FM CE	4152022539	BM	1140	0	10	7,5	400/3/50	8	65	850 x 720 x 980	175
SPINN 7.5X 10 400/50 FM CE	4152022540	BM	996	0	10	7,5	400/3/50	10	65	850 x 720 x 980	175
SPINN 7.5X 13 400/50 FM CE	4152022541	BM	780	0	10	7,5	400/3/50	13	65	850 x 720 x 980	175
SPINN 11 8 400/50 FM CE	4152022542	BM	1620	0	15	11	400/3/50	8	69	850 x 720 x 980	192
SPINN 11 10 400/50 FM CE	4152022543	BM	1416	0	15	11	400/3/50	10	69	850 x 720 x 980	192
SPINN 11 13 400/50 FM CE	4152022544	BM	1152	0	15	11	400/3/50	13	69	850 x 720 x 980	192
SPINN 15 8 400/50 FM CE	4152022545	BM	1860	0	20	15	400/3/50	8	71	850 x 720 x 980	209
SPINN 15 10 400/50 FM CE	4152022546	BM	1680	0	20	15	400/3/50	10	71	850 x 720 x 980	209
SPINN 15 13 400/50 FM CE	4152022547	BM	1332	0	20	15	400/3/50	13	71	850 x 720 x 980	209



SPINN 5.5x-15 kW Tank Mounted

Tank Mounted

Model	Part Number	Configuration	l/min	L	HP	kW	Voltz	Bar	dB(A)	LxWxH (mm)	KG
SPINN 5.5X 8 400/50 TM270 CE	4152022619	TM	846	270	7,5	5,5	400/3/50	8	64	1543 x 720 x 1337	219
SPINN 5.5X 10 400/50 TM270 CE	4152022620	TM	696	270	7,5	5,5	400/3/50	10	64	1543 x 720 x 1337	219
SPINN 5.5X 8 400/50 TM500 CE	4152022621	TM	846	500	7,5	5,5	400/3/50	8	64	1945 x 720 x 1468	272
SPINN 5.5X 10 400/50 TM500 CE	4152022622	TM	696	500	7,5	5,5	400/3/50	10	64	1945 x 720 x 1468	272
SPINN 7.5X 8 400/50 TM270 CE	4152022623	TM	1140	270	10	7,5	400/3/50	8	65	1543 x 720 x 1337	240
SPINN 7.5X 10 400/50 TM270 CE	4152022624	TM	996	270	10	7,5	400/3/50	10	65	1543 x 720 x 1337	240
SPINN 7.5X 8 400/50 TM500 CE	4152022625	TM	1140	500	10	7,5	400/3/50	8	65	1945 x 720 x 1468	295
SPINN 7.5X 10 400/50 TM500 CE	4152022626	TM	996	500	10	7,5	400/3/50	10	65	1945 x 720 x 1468	295
SPINN 7.5X 13 400/50 TM500 CE	4152022627	TM	780	500	10	7,5	400/3/50	13	65	1945 x 720 x 1468	325
SPINN 11 8 400/50 TM270 CE	4152022628	TM	1620	270	15	11	400/3/50	8	69	1543 x 720 x 1337	255
SPINN 11 10 400/50 TM270 CE	4152022629	TM	1416	270	15	11	400/3/50	10	69	1543 x 720 x 1337	255
SPINN 11 8 400/50 TM500 CE	4152022630	TM	1620	500	15	11	400/3/50	8	69	1945 x 720 x 1468	312
SPINN 11 10 400/50 TM500 CE	4152022631	TM	1416	500	15	11	400/3/50	10	69	1945 x 720 x 1468	312
SPINN 11 13 400/50 TM500 CE	4152022632	TM	1152	500	15	11	400/3/50	13	69	1945 x 720 x 1468	344

SPINN 5.5x-15 kW



SPINN 5.5x-15 kW Tank Mounted

Tank Mounted

Model	Part Number	Configuration	l/min	L	HP	kW	Voltz	Bar	dB(A)	LxWxH (mm)	KG
SPINN 15 8 400/50 TM270 CE	4152022633	TM	1860	270	20	15	400/3/50	8	71	1543 x 720 x 1337	270
SPINN 15 10 400/50 TM270 CE	4152022634	TM	1680	270	20	15	400/3/50	10	71	1543 x 720 x 1337	270
SPINN 15 8 400/50 TM500 CE	4152022635	TM	1860	500	20	15	400/3/50	8	71	1945 x 720 x 1468	325
SPINN 15 10 400/50 TM500 CE	4152022636	TM	1680	500	20	15	400/3/50	10	71	1945 x 720 x 1468	325
SPINN 15 13 400/50 TM500 CE	4152022637	TM	1332	500	20	15	400/3/50	13	71	1945 x 720 x 1468	357



SPINN 5.5x-15 kW Tank Mounted Dryer

Tank Mounted Dryer

Model	Part Number	Configuration	l/min	L	HP	kW	Voltz	Bar	dB(A)	LxWxH (mm)	KG	Dryer
SPINN 5.5XE 8 400/50 TM270 CE	4152022638	TMD	846	270	7,5	5,5	400/3/50	8	64	1543 x 720 x 1337	244	Yes
SPINN 5.5XE 10 400/50 TM270 CE	4152022639	TMD	696	270	7,5	5,5	400/3/50	10	64	1543 x 720 x 1337	244	Yes
SPINN 5.5XE 8 400/50 TM500 CE	4152022640	TMD	846	500	7,5	5,5	400/3/50	8	64	1945 x 720 x 1468	297	Yes
SPINN 5.5XE 10 400/50 TM500 CE	4152022641	TMD	696	500	7,5	5,5	400/3/50	10	64	1945 x 720 x 1468	297	Yes
SPINN 7.5XE 8 400/50 TM270 CE	4152022642	TMD	1140	270	10	7,5	400/3/50	8	65	1543 x 720 x 1337	272	Yes
SPINN 7.5XE 10 400/50 TM270 CE	4152022643	TMD	996	270	10	7,5	400/3/50	10	65	1543 x 720 x 1337	272	Yes
SPINN 7.5XE 8 400/50 TM500 CE	4152022644	TMD	1140	500	10	7,5	400/3/50	8	65	1945 x 720 x 1468	320	Yes
SPINN 7.5XE 10 400/50 TM500 CE	4152022645	TMD	996	500	10	7,5	400/3/50	10	65	1945 x 720 x 1468	320	Yes
SPINN 7.5XE 13 400/50 TM500 CE	4152022646	TMD	780	500	10	7,5	400/3/50	13	65	1945 x 720 x 1468	352	Yes
SPINN 11E 8 400/50 TM270 CE	4152022647	TMD	1620	270	15	11	400/3/50	8	69	1543 x 720 x 1337	296	Yes
SPINN 11E 10 400/50 TM270 CE	4152022648	TMD	1416	270	15	11	400/3/50	10	69	1543 x 720 x 1337	296	Yes
SPINN 11E 8 400/50 TM500 CE	4152022649	TMD	1620	500	15	11	400/3/50	8	69	1945 x 720 x 1468	342	Yes
SPINN 11E 10 400/50 TM500 CE	4152022650	TMD	1416	500	15	11	400/3/50	10	69	1945 x 720 x 1468	342	Yes
SPINN 11E 13 400/50 TM500 CE	4152022651	TMD	1152	500	15	11	400/3/50	13	69	1945 x 720 x 1468	372	Yes
SPINN 15E 8 400/50 TM270 CE	4152022652	TMD	1860	270	20	15	400/3/50	8	71	1543 x 720 x 1337	311	Yes
SPINN 15E 10 400/50 TM270 CE	4152022653	TMD	1680	270	20	15	400/3/50	10	71	1543 x 720 x 1337	311	Yes
SPINN 15E 8 400/50 TM500 CE	4152022654	TMD	1860	500	20	15	400/3/50	8	71	1945 x 720 x 1468	354	Yes
SPINN 15E 10 400/50 TM500 CE	4152022655	TMD	1680	500	20	15	400/3/50	10	71	1945 x 720 x 1468	354	Yes
SPINN 15E 13 400/50 TM500 CE	4152022656	TMD	1332	500	20	15	400/3/50	13	71	1945 x 720 x 1468	386	Yes



SPINN 15x-22 kW Base Mounted

Base Mounted

Model	Part Number	Configuration	l/min	L	HP	kW	Voltz	Bar	dB(A)	LxWxH (mm)	KG	Dryer
SPINN 15X 8 400/50 FM CE	4152028920	BM	2450	0	20	15	400/3/50	8	67	1130 x 780 x 1250	313	
SPINN 15X 10 400/50 FM CE	4152028921	BM	2215	0	20	15	400/3/50	10	67	1130 x 780 x 1250	313	
SPINN 18 8 400/50 FM CE	4152028922	BM	3000	0	25	18,5	400/3/50	8	69	1130 x 780 x 1250	328	
SPINN 18 10 400/50 FM CE	4152028923	BM	2590	0	25	18,5	400/3/50	10	69	1130 x 780 x 1250	328	
SPINN 22 8 400/50 FM CE	4152028924	BM	3570	0	30	22	400/3/50	8	70	1130 x 780 x 1250	344	
SPINN 22 10 400/50 FM CE	4152028925	BM	3090	0	30	22	400/3/50	10	70	1400 x 780 x 1250	393	Yes



SPINN 15x-22 kW Base Mounted Dryer

Base Mounted Dryer

Model	Part Number	Configuration	l/min	L	HP	kW	Voltz	Bar	dB(A)	LxWxH (mm)	KG	Dryer
SPINN 15XE 8 400/50 FM CE	4152028932	BMD	2450	0	20	15	400/3/50	8	67	1400 x 780 x 1250	362	Yes
SPINN 15XE 10 400/50 FM CE	4152028933	BMD	2215	0	20	15	400/3/50	10	67	1400 x 780 x 1250	362	Yes
SPINN 18E 8 400/50 FM CE	4152028934	BMD	3000	0	25	18,5	400/3/50	8	69	1400 x 780 x 1250	377	Yes
SPINN 18E 10 400/50 FM CE	4152028935	BMD	2590	0	25	18,5	400/3/50	10	69	1400 x 780 x 1250	377	Yes
SPINN 22E 8 400/50 FM CE	4152028936	BMD	3570	0	30	22	400/3/50	8	70	1400 x 780 x 1250	393	Yes
SPINN 22E 10 400/50 FM CE	4152028937	BMD	3090	0	30	22	400/3/50	10	70	1400 x 780 x 1250	393	Yes



SPINN 15x-22 kW Tank Mounted Dryer

Tank Mounted Dryer

Model	Part Number	Configuration	l/min	L	HP	kW	Voltz	Bar	dB(A)	LxWxH (mm)	KG	Dryer
SPINN 15XE 8 400/50 TM500 CE	4152028944	TMD	2450	500	20	15	400/3/50	8	67	1904 x 780 x 1833	588	Yes
SPINN 15XE 10 400/50 TM500 CE	4152028945	TMD	2215	500	20	15	400/3/50	10	67	1904 x 780 x 1833	588	Yes
SPINN 18E 8 400/50 TM500 CE	4152028946	TMD	3000	500	25	18,5	400/3/50	8	69	1904 x 780 x 1833	603	Yes
SPINN 18E 10 400/50 TM500 CE	4152028947	TMD	2590	500	25	18,5	400/3/50	10	69	1904 x 780 x 1833	603	Yes
SPINN 22E 8 400/50 TM500 CE	4152028948	TMD	3570	500	30	22	400/3/50	8	70	1904 x 780 x 1833	619	Yes
SPINN 22E 10 400/50 TM500 CE	4152028949	TMD	3090	500	30	22	400/3/50	10	70	1904 x 780 x 1833	619	Yes



FORMULA FS 5.5-11 kW Base Mounted

Base Mounted

Model	Part Number	Configuration	l/min	L	HP	kW	Voltz	Bar	dB(A)	LxWxH (mm)	KG
FORMULA 5,5 8 400/50 CE	4152025384	BM	880	0	7,5	5,5	400/3/50	8	62	1065 x 665 x 1070	241
FORMULA 5,5 10 400/50 CE	4152025385	BM	700	0	7,5	5,5	400/3/50	10	62	1065 x 665 x 1070	241
FORMULA 7,5 8 400/50 CE	4152025386	BM	1240	0	10	7,5	400/3/50	8	63	1065 x 665 x 1070	246
FORMULA 7,5 10 400/50 CE	4152025387	BM	1080	0	10	7,5	400/3/50	10	63	1065 x 665 x 1070	246
FORMULA 7,5 13 400/50 CE	4152025388	BM	830	0	10	7,5	400/3/50	13	63	1065 x 665 x 1070	246
FORMULA 11 8 400/50 CE	4152025389	BM	1675	0	15	11	400/3/50	8	65	1150 x 665 x 1070	266
FORMULA 11 10 400/50 CE	4152025390	BM	1510	0	15	11	400/3/50	10	65	1150 x 665 x 1070	266
FORMULA 11 13 400/50 CE	4152025391	BM	1210	0	15	11	400/3/50	13	65	1150 x 665 x 1070	266



FORMULA FS 5.5-11 kW Base Mounted Dryer

Base Mounted Dryer

Model	Part Number	Configuration	l/min	L	HP	kW	Voltz	Bar	dB(A)	LxWxH (mm)	KG	Dryer
FORMULA E 5,5 8 400/50 CE	4152025392	BMD	880	0	7,5	5,5	400/3/50	8	62	1065 x 665 x 1070	268	Yes
FORMULA E 5,5 10 400/50 CE	4152025393	BMD	700	0	7,5	5,5	400/3/50	10	62	1065 x 665 x 1070	268	Yes
FORMULA E 7,5 8 400/50 CE	4152025394	BMD	1240	0	10	7,5	400/3/50	8	63	1065 x 665 x 1070	276	Yes
FORMULA E 7,5 10 400/50 CE	4152025395	BMD	1080	0	10	7,5	400/3/50	10	63	1065 x 665 x 1070	276	Yes
FORMULA E 7,5 13 400/50 CE	4152025396	BMD	830	0	10	7,5	400/3/50	13	63	1065 x 665 x 1070	276	Yes
FORMULA E 11 8 400/50 CE	4152025397	BMD	1675	0	15	11	400/3/50	8	65	1150 x 665 x 1070	296	Yes
FORMULA E 11 10 400/50 CE	4152025398	BMD	1510	0	15	11	400/3/50	10	65	1150 x 665 x 1070	296	Yes
FORMULA E 11 13 400/50 CE	4152025399	BMD	1210	0	15	11	400/3/50	13	65	1150 x 665 x 1070	296	Yes

FORMULA FS 15-22 kW



FORMULA FS 15-22 kW Base Mounted

Base Mounted

Model	Part Number	Configuration	l/min	L	HP	kW	Voltz	Bar	dB(A)	LxWxH (mm)	KG
FORMULA 15 8 400/50 CE	4152025526	BM	2330	0	20	15	400/3/50	8	67	1065 x 665 x 1070	270
FORMULA 15 10 400/50 CE	4152025527	BM	2110	0	20	15	400/3/50	10	67	1065 x 665 x 1070	270
FORMULA 15 13 400/50 CE	4152025528	BM	1690	0	20	15	400/3/50	13	67	1065 x 665 x 1070	270
FORMULA 18 8 400/50 CE	4152025529	BM	3110	0	25	18,5	400/3/50	8	69	1204 x 805 x 1220	361
FORMULA 18 10 400/50 CE	4152025530	BM	2720	0	25	18,5	400/3/50	10	69	1204 x 805 x 1220	361
FORMULA 18 13 400/50 CE	4152025531	BM	2300	0	25	18,5	400/3/50	13	69	1204 x 805 x 1220	361
FORMULA 22 8 400/50 CE	4152025532	BM	3650	0	30	22	400/3/50	8	70	1204 x 805 x 1220	377
FORMULA 22 10 400/50 CE	4152025533	BM	3240	0	30	22	400/3/50	10	70	1204 x 805 x 1220	377
FORMULA 22 13 400/50 CE	4152025534	BM	2770	0	30	22	400/3/50	13	70	1204 x 805 x 1220	377



FORMULA FS 15-22 kW Base Mounted Dryer

Base Mounted Dryer

Model	Part Number	Configuration	l/min	L	HP	kW	Voltz	Bar	dB(A)	LxWxH (mm)	KG	Dryer
FORMULA E 15 8 400/50 CE	4152025535	BMD	2330	0	20	15	400/3/50	8	67	1065 x 665 x 1070	297	Yes
FORMULA E 15 10 400/50 CE	4152025536	BMD	2110	0	20	15	400/3/50	10	67	1065 x 665 x 1070	297	Yes
FORMULA E 15 13 400/50 CE	4152025537	BMD	1690	0	20	15	400/3/50	13	67	1065 x 665 x 1070	297	Yes
FORMULA E 18 8 400/50 CE	4152025538	BMD	3110	0	25	18,5	400/3/50	8	69	1659 x 805 x 1220	434	Yes
FORMULA E 18 10 400/50 CE	4152025539	BMD	2720	0	25	18,5	400/3/50	10	69	1659 x 805 x 1220	434	Yes
FORMULA E 18 13 400/50 CE	4152025540	BMD	2300	0	25	18,5	400/3/50	13	69	1659 x 805 x 1220	434	Yes
FORMULA E 22 8 400/50 CE	4152025541	BMD	3650	0	30	22	400/3/50	8	70	1659 x 805 x 1220	464	Yes
FORMULA E 22 10 400/50 CE	4152025542	BMD	3240	0	30	22	400/3/50	10	70	1659 x 805 x 1220	464	Yes
FORMULA E 22 13 400/50 CE	4152025543	BMD	2770	0	30	22	400/3/50	13	70	1659 x 805 x 1220	464	Yes



FORMULA FS 30-45 kW Base Mounted

Base Mounted

Model	Part Number	Configuration	l/min	L	HP	kW	Voltz	Bar	dB(A)	LxWxH (mm)	KG
FORMULA M30 7,5 400 50 MEAA	4152034924	BM	5130	0	40	30	400/3/50	7,5	72	1330 x 830 x 1555	589
FORMULA M30 8,5 400 50 MEAA	4152034925	BM	5130	0	40	30	400/3/50	8,5	72	1330 x 830 x 1555	589
FORMULA M30 10 400 50 MEAA	4152034926	BM	4560	0	40	30	400/3/50	10	72	1330 x 830 x 1555	589
FORMULA M37 7,5 400 50 MEAA	4152034928	BM	6600	0	50	37	400/3/50	7,5	73	1330 x 830 x 1555	610
FORMULA M37 8,5 400 50 MEAA	4152034929	BM	6090	0	50	37	400/3/50	8,5	73	1330 x 830 x 1555	610
FORMULA M37 10 400 50 MEAA	4152034930	BM	5700	0	50	37	400/3/50	10	73	1330 x 830 x 1555	610
FORMULA M45 7,5 400 50 MEAA	4152034932	BM	7560	0	60	45	400/3/50	7,5	75	1330 x 830 x 1555	629
FORMULA M45 8,5 400 50 MEAA	4152034933	BM	7260	0	60	45	400/3/50	8,5	75	1330 x 830 x 1555	629
FORMULA M45 10 400 50 MEAA	4152034934	BM	6600	0	60	45	400/3/50	10	75	1330 x 830 x 1555	629



FORMULA FS 30-45 kW Base Mounted Dryer

Base Mounted Dryer

Model	Part Number	Configuration	l/min	L	HP	kW	Voltz	Bar	dB(A)	LxWxH (mm)	KG	Dryer
FORMULA ME30 7,5 400 50 MEAA	4152034954	BMD	5130	0	40	30	400/3/50	7,5	72	1330 x 830 x 1555	707	Yes
FORMULA ME30 8,5 400 50 MEAA	4152034955	BMD	5130	0	40	30	400/3/50	8,5	72	1330 x 830 x 1555	707	Yes
FORMULA ME30 10 400 50 MEAA	4152034956	BMD	4560	0	40	30	400/3/50	10	72	1330 x 830 x 1555	707	Yes
FORMULA ME37 7,5 400 50 MEAA	4152034958	BMD	6600	0	50	37	400/3/50	7,5	73	1330 x 830 x 1555	728	Yes
FORMULA ME37 8,5 400 50 MEAA	4152034959	BMD	6090	0	50	37	400/3/50	8,5	73	1330 x 830 x 1555	728	Yes
FORMULA ME37 10 400 50 MEAA	4152034960	BMD	5700	0	50	37	400/3/50	10	73	1330 x 830 x 1555	728	Yes
FORMULA ME45 7,5 400 50 MEAA	4152034962	BMD	7560	0	60	45	400/3/50	7,5	75	1330 x 830 x 1555	747	Yes
FORMULA ME45 8,5 400 50 MEAA	4152034963	BMD	7260	0	60	45	400/3/50	8,5	75	1330 x 830 x 1555	747	Yes
FORMULA ME45 10 400 50 MEAA	4152034964	BMD	6600	0	60	45	400/3/50	10	75	1330 x 830 x 1555	747	Yes

FORMULA FS 30-45 13B kW



FORMULA FS 30-45 kW 13B Base Mounted

Base Mounted

Model	Part Number	Configuration	l/min	L	HP	kW	Voltz	Bar	dB(A)	LxWxH (mm)	KG
FORMULA M30 13 400 50 MEAA	4152034927	BM	4020	0	40	30	400/3/50	13	72	1330 x 830 x 1555	589
FORMULA M37 13 400 50 MEAA	4152034931	BM	5160	0	50	37	400/3/50	13	73	1330 x 830 x 1555	610
FORMULA M45 13 400 50 MEAA	4152034935	BM	5820	0	60	45	400/3/50	13	75	1330 x 830 x 1555	629



FORMULA FS 30-45 kW 13B Base Mounted Dryer

Base Mounted Dryer

Model	Part Number	Configuration	l/min	L	HP	kW	Voltz	Bar	dB(A)	LxWxH (mm)	KG	Dryer
FORMULA ME30 13 400 50 MEAA	4152034957	BMD	4020	0	40	30	400/3/50	13	72	1330 x 830 x 1555	707	Yes
FORMULA ME37 13 400 50 MEAA	4152034961	BMD	5160	0	50	37	400/3/50	13	73	1330 x 830 x 1555	728	Yes
FORMULA ME45 13 400 50 MEAA	4152034965	BMD	5820	0	60	45	400/3/50	13	75	1330 x 830 x 1555	747	Yes

FORMULA FS 55-75 kW Base Mounted



Base Mounted

Model	Part Number	Configuration	l/min	L	HP	kW	Voltz	Bar	dB(A)	LxWxH (mm)	KG
FORMULA M55 A 7,5 MEBB 400	8153340073	BM	10317	0	75	55	400/3/50	7.5	71	1869x1221x1804	1123
FORMULA M55 A 8,5 MEBB 400	8153340074	BM	9667	0	75	55	400/3/50	8.5	71	1869x1221x1804	1123
FORMULA M55 A 10 MEBB 400	8153340075	BM	8633	0	75	55	400/3/50	10	71	1869x1221x1804	1123
FORMULA M75 A 7,5 MEBB 400	8153340076	BM	13200	0	100	75	400/3/50	7.5	73	1869x1221x1804	1189
FORMULA M75 A 8,5 MEBB 400	8153340077	BM	12783	0	100	75	400/3/50	8.5	73	1869x1221x1804	1189
FORMULA M75 A 10 MEBB 400	8153340078	BM	11817	0	100	75	400/3/50	10	73	1869x1221x1804	1189



GENESIS FS 5.5-11 kW Tank Mounted Dryer

Tank Mounted Dryer

Model	Part Number	Configuration	l/min	L	HP	kW	Voltz	Bar	dB(A)	LxWxH (mm)	KG	Dryer
GENESIS 5,5 8 400/50 500 CE	4152025408	TMD	880	500	7,5	5,5	400/3/50	8	62	1935 x 642 x 1689	426	Yes
GENESIS 5,5 10 400/50 500 CE	4152025409	TMD	700	500	7,5	5,5	400/3/50	10	62	1935 x 642 x 1689	426	Yes
GENESIS 5,5 8 400/50 270 CE	4152059596	TMD	880	270	7,5	5,5	400/3/50	8	62	1535x642x1687	338	Yes
GENESIS 5,5 10 400/50 270 CE	4152059597	TMD	700	270	7,5	5,5	400/3/50	10	62	1535x642x1687	338	Yes
GENESIS 7,5 8 400/50 500 CE	4152025410	TMD	1153	500	10	7,5	400/3/50	8	63	1935 x 642 x 1714	431	Yes
GENESIS 7,5 10 400/50 500 CE	4152025411	TMD	1000	500	10	7,5	400/3/50	10	63	1935 x 642 x 1714	431	Yes
GENESIS 7,5 13 400/50 500 CE	4152025412	TMD	810	500	10	7,5	400/3/50	13	63	1935 x 642 x 1714	431	Yes
GENESIS 7,5 8 400/50 270 CE	4152059598	TMD	1153	270	10	7,5	400/3/50	8	63	1535x642x1687	346	Yes
GENESIS 7,5 10 400/50 270 CE	4152059599	TMD	1000	270	10	7,5	400/3/50	10	63	1535x642x1687	346	Yes
GENESIS 7,5 13 400/50 270 CE	4152059600	TMD	810	270	10	7,5	400/3/50	13	63	1535x642x1687	346	Yes
GENESIS 11 8 400/50 500 CE	4152025413	TMD	1675	500	15	11	400/3/50	8	65	1935 x 642 x 1689	451	Yes
GENESIS 11 10 400/50 500 CE	4152025414	TMD	1510	500	15	11	400/3/50	10	65	1935 x 642 x 1689	451	Yes
GENESIS 11 13 400/50 500 CE	4152025415	TMD	1210	500	15	11	400/3/50	13	65	1935 x 642 x 1689	451	Yes
GENESIS 11 8 400/50 270 CE	4152059601	TMD	1675	270	15	11	400/3/50	8	65	1535x642x1687	361	Yes
GENESIS 11 10 400/50 270 CE	4152059602	TMD	1510	270	15	11	400/3/50	10	65	1535x642x1687	361	Yes
GENESIS 11 13 400/50 270 CE	4152059603	TMD	1210	270	15	11	400/3/50	13	65	1535x642x1687	361	Yes



GENESIS FS 15-22 kW Tank Mounted Dryer

Tank Mounted Dryer

Model	Part Number	Configuration	l/min	L	HP	kW	Voltz	Bar	dB(A)	LxWxH (mm)	KG	Dryer
GENESIS 15 8 400/50 500 CE	4152025547	TMD	2330	500	20	15	400/3/50	8	67	1935 x 665 x 1689	455	Yes
GENESIS 15 10 400/50 500 CE	4152025548	TMD	2110	500	20	15	400/3/50	10	67	1935 x 665 x 1689	455	Yes
GENESIS 15 13 400/50 500 CE	4152025549	TMD	1690	500	20	15	400/3/50	13	67	1935 x 665 x 1689	455	Yes
GENESIS 15 8 400/50 270 CE	4152059623	TMD	2330	270	20	15	400/3/50	8	67	1535x642x1687	367	Yes
GENESIS 15 10 400/50 270 CE	4152059624	TMD	2110	270	20	15	400/3/50	10	67	1535x642x1687	367	Yes
GENESIS 15 13 400/50 270 CE	4152059625	TMD	1690	270	20	15	400/3/50	13	67	1535x642x1687	367	Yes
GENESIS 18 8 400/50 500 CE	4152025550	TMD	3110	500	25	18,5	400/3/50	8	69	1950 x 810 x 1850	624	Yes
GENESIS 18 10 400/50 500 CE	4152025551	TMD	2720	500	25	18,5	400/3/50	10	69	1950 x 810 x 1850	624	Yes
GENESIS 18 13 400/50 500 CE	4152025552	TMD	2300	500	25	18,5	400/3/50	13	69	1950 x 810 x 1850	624	Yes
GENESIS 22 8 400/50 500 CE	4152025553	TMD	3650	500	30	22	400/3/50	8	70	1950 x 810 x 1850	654	Yes
GENESIS 22 10 400/50 500 CE	4152025554	TMD	3240	500	30	22	400/3/50	10	70	1950 x 810 x 1850	654	Yes
GENESIS 22 13 400/50 500 CE	4152025555	TMD	2770	500	30	22	400/3/50	13	70	1950 x 810 x 1850	654	Yes

Oil-Injected Screw Compressors Variable Speed



Oil-Injected Screw Compressors Variable Speed

Variable Speed Drive (VSD) air compressor can operate anywhere in the range between its minimum and maximum speed, and it automatically adjusts the speed so production of compressed air matches demand in real time. When demand increases, the motor speeds up. When demand decreases, the motor slows down.

FORMULA VS 7.5-15 kW

Choosing the right compressor for your business is crucial.

167

Designed to deliver cost and energy efficiency, performance and reliability, ABAC's new Formula series of variable speed drive (VSD) compressors offer the ultimate solution. This results in average energy savings of up to 35% as well as an average reduction of up to 25% in the compressor's total lifecycle cost.

FORMULA VS 15X-26 kW

Choosing the right compressor for your business is crucial.

168

Designed to deliver cost and energy efficiency, performance and reliability, ABAC's new Formula series of variable speed drive (VSD) compressors offer the ultimate solution. This results in average energy savings of up to 35% as well as an average reduction of up to 25% in the compressor's total lifecycle cost.

FORMULA VS 30-45 kW

FORMULA M Gear Driven variable speed will grant top performances and offer considerable savings on your energy consumption. Easy to use, reliable, efficient: FORMULA M is simply about that. Evolved to tackle the toughest industrial jobs, this air compressor results in cost savings and high performances.

169

FORMULA VS 30-45 13B kW

FORMULA M Gear Driven variable speed will grant top performances and offer considerable savings on your energy consumption. Easy to use, reliable, efficient: FORMULA M is simply about that. Evolved to tackle the toughest industrial jobs, this air compressor results in cost savings and high performances.

170

GENESIS VS 7.5-15 kW

Designed to deliver cost and energy efficiency, performance and reliability, ABAC's new Genesis series of variable speed drive (VSD) compressors offer the ultimate solution.

171

As one of the market leaders in VSD technology, ABAC's latest range of oil-injected screw compressors features an innovative direct drive transmission, which automatically adjusts the speed of the motor in response to demand for compressed air.

GENESIS VS 15X-26 kW

Designed to deliver cost and energy efficiency, performance and reliability, ABAC's new Genesis series of variable speed drive (VSD) compressors offer the ultimate solution.

172

As one of the market leaders in VSD technology, ABAC's latest range of oil-injected screw compressors features an innovative direct drive transmission, which automatically adjusts the speed of the motor in response to demand for compressed air.

SPINN VS 2.2-7.5 kW

The ABAC Spinn 2.2-7.5 VSD compressors are the ultimate solution for reliable and long-lasting performance. Thanks to their innovative technology, they are more dependable than ever before. With Variable Speed Drive, these compressors can operate at lower speeds, which means less wear and tear on their components. This compact compressor boasts significantly lower noise levels, making it easy to install close to the point of use.

173



FORMULA VS 7.5-15 kW Base Mounted

Base Mounted

Model	Part Number	Configuration	l/min	HP	kW	Voltz	Bar	dB(A)	LxWxH (mm)	KG
FORMULA I 7.5 13 400/50 FM	4152019800	BM	829	10	7.5	400/3/50	12.5	64	995x655x1045	235
FORMULA I 11 13 400/50 FM	4152019805	BM	1205	15	11	400/3/50	12.5	64	995x655x1045	251
FORMULA I 15 13 400/50 FM	4152019810	BM	1394	20	15	400/3/50	12.5	65	995x655x1045	254

FORMULA VS 15X-26 kW



FORMULA VS 15X-26 kW Base Mounted

Base Mounted

Model	Part Number	Configuration	l/min	HP	kW	Voltz	Bar	dB(A)	LxWxH (mm)	KG
FORMULA I 15X 12,5 400/50 CE	4152033171	BM	2064	20	15	400/3/50	12.5	68	1200x835x1220	310
FORMULA I 18 12,5 400/50 CE	4152033174	BM	2270	25	18.5	400/3/50	12.5	70	1200x835x1220	325
FORMULA I 22 12,5 400/50 CE	4152033177	BM	2934	30	22	400/3/50	12.5	71	1200x835x1220	330
FORMULA I 26 12,5 400/50 CE	4152033180	BM	3263	35	26	400/3/50	12.5	72	1200x835x1220	350



FORMULA VS 15X-26 kW Base Mounted Dryer

Base Mounted Dryer

Model	Part Number	Configuration	l/min	HP	kW	Voltz	Bar	dB(A)	LxWxH (mm)	KG	Dryer
FORMULA EI 15X 12,5 400/50 CE	4152033172	BMD	2064	20	15	400/3/50	12.5	68	1450x835x1220	355	Yes
FORMULA EI 18 12,5 400/50 CE	4152033175	BMD	2270	25	18.5	400/3/50	12.5	70	1450x835x1220	375	Yes
FORMULA EI 22 12,5 400/50 CE	4152033178	BMD	2934	30	22	400/3/50	12.5	71	1450x835x1220	385	Yes
FORMULA EI 26 12,5 400/50 CE	4152033181	BMD	3263	35	26	400/3/50	12.5	72	1450x835x1220	400	Yes



FORMULA VS 30-45 kW Base Mounted

Base Mounted

Model	Part Number	Configuration	l/min	L	HP	kW	Voltz	Bar	dB(A)	LxWxH (mm)	KG
FORMULA MI30 10 400 50 MEAA	4152034936	BM	1788 - 4566	0	40	30	400/3/50	10	72	1330 x 830 x 1555	605
FORMULA MI37 10 400 50 MEAA	4152034937	BM	2280 - 5550	0	50	37	400/3/50	10	73	1330 x 830 x 1555	626
FORMULA MI45 10 400 50 MEAA	4152034938	BM	2256 - 6732	0	60	45	400/3/50	10	75	1330 x 830 x 1555	656



FORMULA VS 30-45 kW Base Mounted Dryer

Base Mounted Dryer

Model	Part Number	Configuration	l/min	L	HP	kW	Voltz	Bar	dB(A)	LxWxH (mm)	KG	Dryer
FORMULA MEI30 10 400 50 MEAA	4152034966	BMD	1788 - 4566	0	40	30	400/3/50	10	72	1330 x 830 x 1555	723	Yes
FORMULA MEI37 10 400 50 MEAA	4152034967	BMD	2280 - 5550	0	50	37	400/3/50	10	73	1330 x 830 x 1555	744	Yes
FORMULA MEI45 10 400 50 MEAA	4152034968	BMD	2256 - 6732	0	60	45	400/3/50	10	75	1330 x 830 x 1555	774	Yes

FORMULA VS 30-45 13B kW



FORMULA VS 30-45 kW 13B Base Mounted

Base Mounted

Model	Part Number	Configuration	l/min	L	HP	kW	Voltz	Bar	dB(A)	LxWxH (mm)	KG
FORMULA MI30 13 400 50 MEAA	4152034939	BM	2232 - 3750	0	40	30	400/3/50	13	72	1330 x 830 x 1555	605
FORMULA MI37 13 400 50 MEAA	4152034940	BM	2080 - 4542	0	50	37	400/3/50	13	73	1330 x 830 x 1555	626
FORMULA MI45 13 400 50 MEAA	4152034941	BM	2184 - 5580	0	60	45	400/3/50	13	75	1330 x 830 x 1555	656



FORMULA VS 30-45 kW 13B Base Mounted Dryer

Base Mounted Dryer

Model	Part Number	Configuration	l/min	L	HP	kW	Voltz	Bar	dB(A)	LxWxH (mm)	KG	Dryer
FORMULA MEI30 13 400 50 MEAA	4152034969	BMD	2232 - 3750	0	40	30	400/3/50	13	72	1330 x 830 x 1555	723	Yes
FORMULA MEI37 13 400 50 MEAA	4152034970	BMD	2080 - 4542	0	50	37	400/3/50	13	73	1330 x 830 x 1555	744	Yes
FORMULA MEI45 13 400 50 MEAA	4152034971	BMD	2184 - 5580	0	60	45	400/3/50	13	75	1330 x 830 x 1555	774	Yes



GENESIS VS 7.5-15 kW Tank Mounted

Tank Mounted

Model	Part Number	Configuration	l/min	L	HP	kW	Voltz	Bar	dB(A)	LxWxH (mm)	KG
GENESIS I 7.5 13 400/50 270CE	4152019801	TM	829	270	10	7.5	400/3/50	12.5	64	1535x655x1535	319
GENESIS I 7.5 13 400/50 500CE	4152019802	TM	829	500	10	7.5	400/3/50	12.5	64	1935x655x1665	393
GENESIS I 11 13 400/50 270CE	4152019806	TM	1205	270	15	11	400/3/50	12.5	64	1535x655x1535	332
GENESIS I 11 13 400/50 500CE	4152019807	TM	1205	500	15	11	400/3/50	12.5	64	1935x655x1665	417
GENESIS I 15 13 400/50 270CE	4152019811	TM	1394	270	20	15	400/3/50	12.5	65	1535x655x1535	335
GENESIS I 15 13 400/50 500CE	4152019812	TM	1394	500	20	15	400/3/50	12.5	65	1935x655x1665	420



GENESIS VS 7.5-15 kW Tank Mounted Dryer

Tank Mounted Dryer

Model	Part Number	Configuration	l/min	L	HP	kW	Voltz	Bar	dB(A)	LxWxH (mm)	KG	Dryer
GENESIS EI 7.5 13 400/50 270CE	4152019803	TMD	829	270	10	7.5	400/3/50	12.5	64	1535x655x1550	353	Yes
GENESIS EI 7.5 13 400/50 500CE	4152019804	TMD	829	500	10	7.5	400/3/50	12.5	64	1935x655x1680	447	Yes
GENESIS EI 11 13 400/50 270CE	4152019808	TMD	1205	270	15	11	400/3/50	12.5	64	1535x655x1550	380	Yes
GENESIS EI 11 13 400/50 500CE	4152019809	TMD	1205	500	15	11	400/3/50	12.5	64	1935x655x1680	465	Yes
GENESIS EI 15 13 400/50 270CE	4152019813	TMD	1394	270	20	15	400/3/50	12.5	65	1535x655x1550	398	Yes
GENESIS EI 15 13 400/50 500CE	4152019814	TMD	1394	500	20	15	400/3/50	12.5	65	1935x655x1680	483	Yes



GENESIS VS 15X-26 kW Tank Mounted Dryer

Tank Mounted Dryer

Model	Part Number	Configuration	l/min	L	HP	kW	Voltz	Bar	dB(A)	LxWxH (mm)	KG	Dryer
GENESIS EI15X12,5 400/50 500CE	4152033173	TMD	2064	500	20	15	400/3/50	12.5	68	1940x835x1835	530	Yes
GENESIS EI18 12,5 400/50 500CE	4152033176	TMD	2270	500	25	18.5	400/3/50	12.5	70	1940x835x1835	550	Yes
GENESIS EI22 12,5 400/50 500CE	4152033179	TMD	2934	500	30	22	400/3/50	12.5	71	1940x835x1835	560	Yes
GENESIS EI26 12,5 400/50 500CE	4152033182	TMD	3263	500	35	26	400/3/50	12.5	72	1940x835x1835	575	Yes

SPINN VS 2.2-7.5 kW Base Mounted

Base Mounted



Model	Part Number	Configuration	l/min	HP	kW	Voltz	Bar	dB(A)	LxWxH (mm)	KG
SPINN2,2 8 400/50 CE	4152060800	BM	360	3	2.2	400/3/50	8	57	620x630x955	120
SPINN2,2 10 400/50 CE	4152060801	BM	293	3	2.2	400/3/50	10	57	620x630x955	120
SPINN3 8 400/50 CE	4152060806	BM	460	4	3	400/3/50	8	57	620x630x955	125
SPINN3 10 400/50 CE	4152060807	BM	361	4	3	400/3/50	10	57	620x630x955	125
SPINN4 8 400/50 CE	4152060812	BM	581	5.5	4	400/3/50	8	58	620x630x955	130
SPINN4 10 400/50 CE	4152060813	BM	503	5.5	4	400/3/50	10	58	620x630x955	130
SPINN5,5 8 400/50 CE	4152060818	BM	894	7.5	5.5	400/3/50	8	61	620x630x955	140
SPINN5,5 10 400/50 CE	4152060819	BM	758	7.5	5.5	400/3/50	10	61	620x630x955	140
SPINN7,5 8 400/50 CE	4152060824	BM	1035	10	7.5	400/3/50	8	61	620x630x955	150
SPINN7,5 10 400/50 CE	4152060825	BM	965	10	7.5	400/3/50	10	61	620x630x955	150



SPINN VS 2.2-7.5 kW Tank Mounted

Tank Mounted

Model	Part Number	Configuration	l/min	L	HP	kW	Voltz	Bar	dB(A)	LxWxH (mm)	KG
SPINN2,2 8 400/50 200 CE	4152060802	TM	360	200	3	2.2	400/3/50	8	57	1430x600x1265	175
SPINN2,2 10 400/50 200 CE	4152060803	TM	293	200	3	2.2	400/3/50	10	57	1430x600x1265	175
SPINN3 8 400/50 200 CE	4152060808	TM	460	200	4	3	400/3/50	8	57	1430x600x1265	180
SPINN3 10 400/50 200 CE	4152060809	TM	361	200	4	3	400/3/50	10	57	1430x600x1265	180
SPINN4 8 400/50 200 CE	4152060814	TM	581	200	5.5	4	400/3/50	8	58	1430x600x1265	185
SPINN4 10 400/50 200 CE	4152060815	TM	503	200	5.5	4	400/3/50	10	58	1430x600x1265	185
SPINN5,5 8 400/50 200 CE	4152060820	TM	894	200	7.5	5.5	400/3/50	8	61	1430x600x1265	195
SPINN5,5 10 400/50 200 CE	4152060821	TM	758	200	7.5	5.5	400/3/50	10	61	1430x600x1265	195
SPINN7,5 8 400/50 200 CE	4152060826	TM	1035	200	10	7.5	400/3/50	8	61	1430x600x1265	205
SPINN7,5 10 400/50 200 CE	4152060827	TM	965	200	10	7.5	400/3/50	10	61	1430x600x1265	205

SPINN VS 2.2-7.5 kW



SPINN VS 2.2-7.5 kW Tank Mounted Dryer

Tank Mounted Dryer

Model	Part Number	Configuration	l/min	L	HP	kW	Voltz	Bar	dB(A)	LxWxH (mm)	KG	Dryer
SPINN2,2E I 8 400/50 200 CE	4152060804	TMD	360	200	3	2.2	400/3/50	8	57	1430x600x1265	200	Yes
SPINN2,2E I 10 400/50 200 CE	4152060805	TMD	293	200	3	2.2	400/3/50	10	57	1430x600x1265	200	Yes
SPINN3E I 8 400/50 200 CE	4152060810	TMD	460	200	4	3	400/3/50	8	57	1430x600x1265	205	Yes
SPINN3E I 10 400/50 200 CE	4152060811	TMD	361	200	4	3	400/3/50	10	57	1430x600x1265	205	Yes
SPINN4E I 8 400/50 200 CE	4152060816	TMD	581	200	5.5	4	400/3/50	8	58	1430x600x1265	210	Yes
SPINN4E I 10 400/50 200 CE	4152060817	TMD	503	200	5.5	4	400/3/50	10	58	1430x600x1265	210	Yes
SPINN5,5E I 8 400/50 200 CE	4152060822	TMD	894	200	7.5	5.5	400/3/50	8	61	1430x600x1265	220	Yes
SPINN5,5E I 10 400/50 200 CE	4152060823	TMD	758	200	7.5	5.5	400/3/50	10	61	1430x600x1265	220	Yes
SPINN7,5E I 8 400/50 200 CE	4152060828	TMD	1035	200	10	7.5	400/3/50	8	61	1430x600x1265	235	Yes
SPINN7,5E I 10 400/50 200 CE	4152060829	TMD	965	200	10	7.5	400/3/50	10	61	1430x600x1265	235	Yes



Air Treatment

Air. Anytime. Anywhere.

Why air treatment?

Protect your investment with ABAC air treatment

The importance of air quality

Air treatment solutions from ABAC will protect your compressed air investment.

Compressed air treatment is a critical process that provides the constant delivery of **CLEAN AND DRY** compressed air.

This is essential for maintaining the efficiency and longevity of downstream equipment and ensures that the quality of air is always safe for the environment.

ABAC's air treatment dehumidifies and cleans compressed air with the use of filters, separators and a dryer. The temperature of the air is also regulated so that the dew point of the air is lowered to avoid condensation.

All hazardous particles, including atomized oil, are removed from the system, as these can cause damage to compressed air tools and leaks in pipework if not filtered out. Finally, ABAC condensate drains and oil-water separators ensure that process waste is safely handled to protect your workplace and the environment.

Ultimately, compressed air that is clean and dry is **VALUABLE AIR**.

By integrating ABAC air treatment solutions into your compressed air system, not only will it run more efficiently and for longer, the total cost of ownership will be lower as a result of this preventative maintenance approach.

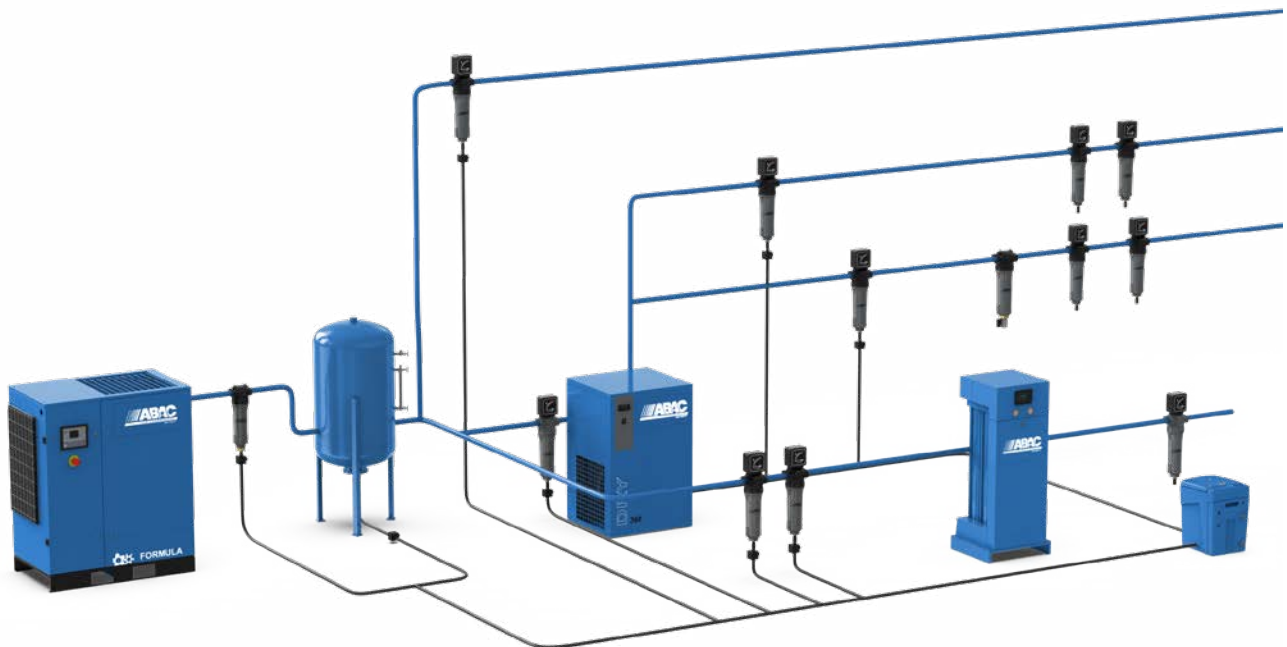

Suitable for special applications such as:

Paint spraying
Laboratory

Food production
Pharmaceutical

Filtration

Pure air means pure protection

Filters are a critical component of compressed air treatment. By removing water, oil, impurities and particulates, your system will run more efficiently and cost-effectively. Filtration also prolongs the life of the compressor, pipework and downstream air tools by minimising the risk of corrosion and leaks, whilst maintaining optimum performance.

ABAC's range of high efficiency filters remove particulates down to 0.01 μm without any significant pressure drop, ensuring unmatched air quality, whatever your application.



Filtration Grades

	P	G	S	C	D	V
Particle removal (micron)	5	-	1	-	0.01	-
Outlet oil aerosol concentration (mg/m ³)	1	0.3	-	0.01	-	0.003
Total mass efficiency (%)	>90	>99.25	-	>99.9	-	-
Quality class of air at outlet (particles / oil)	4 / 3	- / 3	3 / -	- / 2	1 / -	- / 1
Initial pressure drop over filter in dry applications (bar)	0.05	0.055	0.055	0.085	0.085	0.115
Initial pressure drop over filter in wet applications (bar)	0.08	0.125	-	0.125	-	-

CORRECTION FACTORS

For maximum flow rate- multiply model flow rate by the correction factor corresponding to the minimum operating pressure

Operating pressure barg (psig)	4 (58)	5 (72)	6 (87)	7 (100)	8 (115)	10 (145)	12 (174)	14 (203)	16 (232)	20 (290)
Correction factor	0,76	0,84	0,92	1,00	1,07	1,19	1,31	1,41	1,51	1,6



Drying

Removing moisture removes risk

During the compression process, the compressor turns humidity in the intake air into condensate. ABAC's range of refrigerant and desiccant dryers are designed to remove water from any compressed air system and pipework, even at high flow rates, minimising the risks of corrosion and equipment breakdown. It is crucial that process air is consistent in all applications, all year round. By ensuring an ABAC dryer is correctly matched to your system, you can have peace of mind with low servicing costs, without compromising air quality.

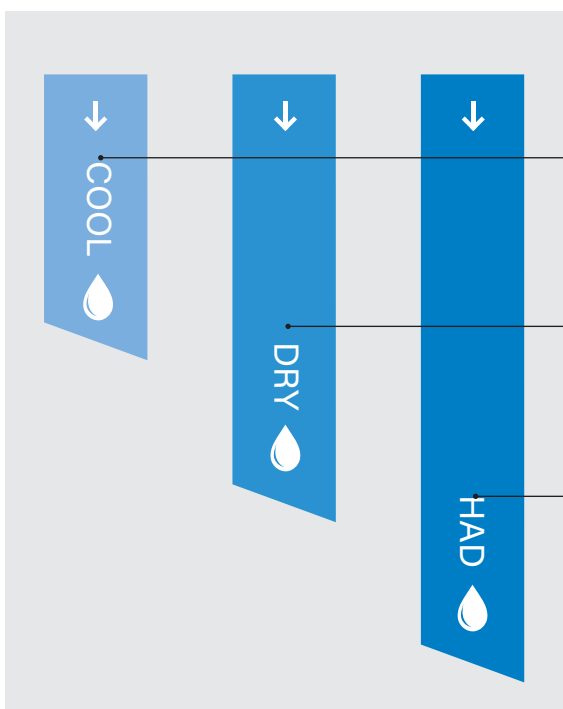

Performance by Dewpoint (°C)

COOL

For most applications, the COOL range is perfectly-suited. Offering a PDP of 5°C thanks to compact internal technologies, it effortlessly balances low cost with high performance.

DRY

For some more demanding applications, a lower PDP of 3°C is required. This is suited for more complicated applications which have a high demand for treated air.

HAD

For the ultimate in air treatment, the HAD offers the highest-performance solution: from -40°C to -70°C constant PDP options for the most rugged inbound airflows, the HAD effortlessly treats air in the harshest environments, as the most reliable and efficient desiccant dryer ever produced by ABAC.

Refrigerant vs Desiccant - choosing the right dryer

Refrigerant dryers are typically the most appropriate dryer for industrial applications and are cost-effective to operate and maintain.

The compressed air is cooled to a dew point of around 3°C so that any condensing water can be removed. The dry air is then heated back to room temperature to prevent condensation forming inside the pipework. Desiccant dryers, sometimes referred to as adsorption dryers, use a hygroscopic

granular material, such as silica gel, to remove moisture from the air. This chemical process produces air that is much drier than from a refrigerant dryer. Typically desiccant dryers produce air with a dew point of -20°C to -40°C, which are therefore more expensive to buy and operate. Desiccant dryers are usually required for applications such as food production, pharmaceutical, laboratory and specialist paint spraying environments.

Dependable

Superior-quality components provide long-lasting performance, even in the harshest environmental conditions. This guarantees your satisfaction with the ABAC range of refrigerant and desiccant drying technologies.

Efficient

Using zero-loss drain technology minimises energy consumption, reducing cost of ownership and environmental impact.

Innovative

Hot-gas bypass and active mesh vapour capture are among the market-leading methods employed in ABAC dryers to deliver superior performance combined with unparalleled reliability.

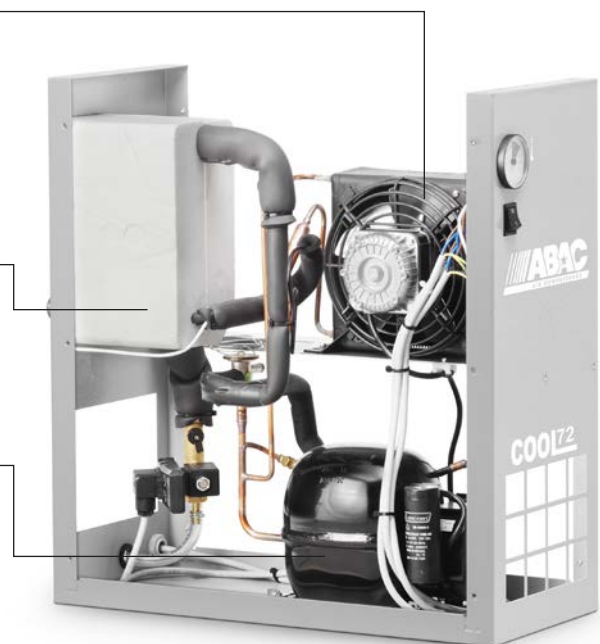

Pressure Dewpoint

+7 degC



-70 degC

Flow range

120 l/min



18 000 l/min

Inlet temperature

+5 degC



+50 degC

Pressure range

4



16

*not all units can reach the stated values. For further information on your specific requirements, please contact your local ABAC sales advisor.

Storage and condensate management

Be smart, be clean

For the optimum compressed air system, that enables premium quality air to be available on demand, the installation of an ABAC air receiver and separator provides an industry leading storage and condensate management solution.

Correctly sizing the air receiver for your application will provide a number of benefits, including:

- **Less waste during off-duty periods**
- **Overall smoother operation**
- **Avoidance of mechanical stress on components**



Types of air receiver

Painted vessels

Painted vessels are used in the majority of environments where the air receiver is not submitted to extreme weather conditions and when 100% clean air is not an absolute prerequisite. The exterior paint ensures basic protection against corrosion.

Galvanized vessels

Galvanization protects steel against corrosion. In this process, the vessel is completely submerged in a zinc liquid bath, which coats the entire surface of the tank, ensuring full protection of the steel.

Vitrified vessels (Vitroflex®)

These vessels are treated with vitreous enamel, making them both water and steam resistant. Once applied, the vessel is baked at 850°C, until the enamel no longer absorbs water and fully protects the metal surface against corrosion.

For best performance, the calculation should be compressor power in HP x 30. For example, a 10HP compressor would require an air receiver with a capacity of 300 litres. ABAC oil/water separators collect the separated residual oil in a suitable container, allowing the water which has been cleared of impurities to be drained. Special oleophilic and carbon filters make this an environmentally sound and economical solution to the disposal of condensate.



Key features

- Storage capacity to handle high air consumption.
- Stabilize pressure peaks and provide a stable air flow for pneumatic tools.
- Separation and removal of condensate.
- Avoidance of unstable pressure peaks.
- Prevents over-cycling of the compressor.

Dryers



Dryers

ABAC compressed air dryers offer high-performance combined with low energy consumption, providing effective air treatment without compromising running cost. With both refrigerant and desiccant dryers on offer, the ABAC range covers the broadest operational conditions to deliver optimal air quality.

Adsorption Dryers

ABAC adsorption dryers incorporate the latest in desiccant material technology to provide a consistent pressure dewpoint among the lowest on the market. For the most demanding applications requiring dry air.

184

Refrigeration Dryers

The refrigerant dryer range by ABAC provides low energy consumption alongside a low pressure dewpoint, comfortably adapting to the needs of most applications. Even in harsh environments, our refrigeration dryers are up to the task!

185

Adsorption Dryers

HAD



The HAD dryer range offers the ultimate in compressed air treatment. With a pressure dewpoint offered down to -70°C, it offers dependable vapour removal in the most harsh inlet conditions.

Model	Part Number	l/min	Voltz	LxWxH (mm)	KG	Max. work. pressure bar	Dimensions of inlet and outlet connections
HAD 7 STD 16B CE ABC (D2)	8102822304	116	230/1/50	281 x 92 x 445	13	16	3/8"
HAD 11 STD 16B CE ABC (D3)	8102822312	167	230/1/50	281 x 92 x 504	14	16	3/8"
HAD 18 STD 16B CE ABC (D5)	8102822320	283	230/1/50	281 x 92 x 635	17	16	3/8"
HAD 25 STD 16B CE ABC (D7)	8102822338	433	230/1/50	281 x 92 x 815	21	16	3/8"
HAD 40 STD 16B CE ABC (D12)	8102822346	699	230/1/50	281 x 92 x 1065	27	16	3/8"
HAD 60 STD 16B CE ABC (D16)	8102822353	983	230/1/50	281 x 92 x 1460	32	16	3/8"
HAD650STD11BAR230V CE ABC D150	8102823120	10789	230/1/50	960 x 754 x 1716	415	11	1 1/2"
HAD650STD16BAR230V CE ABC D150	8102823138	12900	230/1/50	960 x 754 x 1716	415	16	1 1/2"
HAD650CD 11BAR230V CE ABC D150	8102823146	10789	230/1/50	960 x 754 x 1716	415	11	1 1/2"
HAD650CD 16BAR230V CE ABC	8102824235	12900	230/1/50	960 x 754 x 1716	650	16	1 1/2"
HAD800STD 11BAR230VCE ABC D185	8102823153	13196	230/1/50	960 x 754 x 1716	445	11	1 1/2"
HAD800STD16BAR230V CE ABC D185	8102823161	15900	230/1/50	960 x 754 x 1716	445	16	1 1/2"
HAD800CD 11BAR230V CE ABC D185	8102823179	13196	230/1/50	960 x 754 x 1716	445	11	1 1/2"
HAD800CD 16BAR230V CE ABC D185	8102823187	15900	230/1/50	960 x 754 x 1716	445	16	1 1/2"
HAD1080STD11BAR230VCE ABC D250	8102823195	18010	230/1/50	1064 x 883 x 1832	600	11	2"
HAD1080STD16BAR230VCE ABC D250	8102823203	21600	230/1/50	1064 x 883 x 1832	600	16	2"
HAD1080CD11BAR230V CE ABC D250	8102823211	18010	230/1/50	1064 x 883 x 1832	600	11	2"
HAD1080CD16BAR230V CE ABC D250	8102823229	21600	230/1/50	1064 x 883 x 1832	600	16	2"
HAD1300STD11BAR230VCE ABC D300	8102823237	21606	230/1/50	1118 x 859 x 1869	650	11	2"
HAD1300STD16BAR230VCE ABC D300	8102823245	25800	230/1/50	1118 x 859 x 1869	650	16	2"
HAD1300CD11BAR230V CE ABC D300	8102823252	21606	230/1/50	1118 x 859 x 1869	650	11	2"
HAD1300CD16BAR230V CE ABC D300	8102823260	25800	230/1/50	1118 x 859 x 1869	650	16	2"

DRY

The ABAC DRY offers superior performance for more demanding applications, and with inlet volumes up to 18,000L/min, it can cope with significant loads with ease.



Model	Part Number	Voltz	LxWxH (mm)	KG	Max. work. pressure bar	Flow rate @3°C PDP l/m	Dimensions of inlet and outlet connections
DRY250(E7)230/50-I-CE-	4102005405	230/1/50	460 x 560 x 789	53	14	3596	1 1/2" F
DRY250(E7)230/60-I-CE-	4102005410	230/1/60	460 x 560 x 789	53	14	3596	1 1/2" F
DRY290(E7,5)230/50-I-CE-	4102005406	230/1/50	460 x 560 x 789	60	14	4106	1 1/2" F
DRY290(E7,5)230/60-I-CE-	4102005411	230/1/60	460 x 560 x 789	60	14	4106	1 1/2" F
DRY360(E8)230/50-I-CE-	4102005407	230/1/50	460 x 560 x 789	65	14	5210	1 1/2" F
DRY360(E8)230/60-I-CE-	4102005412	230/1/60	460 x 560 x 789	65	14	5210	1 1/2" F
DRY460(E9)230/50-I-CE-	4102005408	230/1/50	580 x 590 x 899	80	14	6513	1 1/2" F
DRY460(E9)230/60-I-CE-	4102005413	230/1/60	580 x 590 x 899	80	14	6513	1 1/2" F
DRY530(E10)230/50-I-CE-	4102005409	230/1/50	580 x 590 x 899	80	14	7702	1 1/2" F
DRY530(E10)230/60-I-CE-	4102005414	230/1/60	580 x 590 x 899	80	14	7702	1 1/2" F
DRY690(E11)400/50-I-CE	4102005596	400/3/50	735 x 898 x 962	128	14	9996	2" F
DRY690(E11)460/60-I-CE	4102005600	460/3/60	735 x 898 x 962	128	14	9996	2" F
DRY830(E12)400/50-I-CE	4102005597	400/3/50	735 x 898 x 962	146	14	12006	2" F
DRY830(E12)460/60-I-CE	4102005601	460/3/60	735 x 898 x 962	146	14	12006	2" F
DRY1040(E13)400/50-I-CE	4102005598	400/3/50	735 x 898 x 962	158	14	15008	2 1/2" F
DRY1040(E13)460/60-I-CE	4102005602	460/3/60	735 x 898 x 962	158	14	15008	2 1/2" F
DRY1260(E14)400/50-I-CE	4102005599	400/3/50	735 x 898 x 962	165	14	18010	2 1/2" F
DRY1260(E14)460/60-I-CE	4102005603	460/3/60	735 x 898 x 962	165	14	18010	2 1/2" F
DRY 20 (E0) 230/50 ABC	4102005869	230/1/50	350 x 500 x 450	19	16	267	1/2" or 3/4" M
DRY 20 (E0) 230/60 ABC	4102005875	230/1/60	350 x 500 x 450	19	16	267	1/2" or 3/4" M
DRY 25 (E0) 230/50 ABC	4102005870	230/1/50	350 x 500 x 450	19	16	350	1/2" or 3/4" M
DRY 25 (E0) 230/60 ABC	4102005876	230/1/60	350 x 500 x 450	19	16	350	1/2" or 3/4" M
DRY 45 (E1) 230/50 ABC	4102005871	230/1/50	350 x 500 x 450	19	16	600	1/2" or 3/4" M
DRY 45 (E1) 230/60 ABC	4102005877	230/1/60	350 x 500 x 450	19	16	600	1/2" or 3/4" M
DRY 60 (E2) 230/50 ABC	4102005872	230/1/50	350 x 500 x 450	20	16	850	1/2" or 3/4" M
DRY 60 (E2) 230/60 ABC	4102005878	230/1/60	350 x 500 x 450	20	16	850	1/2" or 3/4" M
DRY 85 (E3) 230/50 ABC	4102005873	230/1/50	350 x 500 x 450	25	16	1200	1/2" or 3/4" M
DRY 85 (E3) 230/60 ABC	4102005879	230/1/60	350 x 500 x 450	25	16	1200	1/2" or 3/4" M
DRY 130 (E4) 230/50 ABC	4102005874	230/1/50	350 x 500 x 450	27	16	1824	1/2" or 3/4" M
DRY 130 (E4) 230/60 ABC	4102005880	230/1/60	350 x 500 x 450	27	16	1824	1/2" or 3/4" M
DRY165(E5)230/50-I-CE-AB	4102005884	230/1/50	370 x 500 x 764	44	16	2350	1" F
DRY210(E6)230/50-I-CE-AB	4102005885	230/1/50	370 x 500 x 764	44	16	3000	1" F
DRY165(E5)230/60-I-CE-AB	4102005886	230/1/60	370 x 500 x 764	44	14	2350	1" F
DRY210(E6)230/60-I-CE-AB	4102005887	230/1/60	370 x 500 x 764	44	14	3000	1" F

Refrigeration Dryers



COOL

The COOL range is the perfect partner for most air treatment applications, offering a pressure dewpoint of +5°C alongside low energy consumption.

Model	Part Number	Voltz	LxWxH (mm)	KG	Max. work. pressure bar	Flow rate @5°C PDP l/m	Dimensions of inlet and outlet connections
COOL21(C0)230/50-A-AB-CE	4102003602	230/1/50	350 x 500 x 450	19	16	350	3/4" M
COOL36(C1)230/50-A-AB-CE	4102003603	230/1/50	350 x 500 x 450	19	16	600	3/4" M
COOL51(C2)230/50-A-AB-CE	4102003604	230/1/50	350 x 500 x 450	19	16	850	3/4" M
COOL72(C3)230/50-A-AB-CE	4102003605	230/1/50	350 x 500 x 450	20	16	1200	3/4" M
COOL110(C4)230/50-A-AB-CE	4102003606	230/1/50	350 x 500 x 450	25	16	1825	3/4" M
COOL21(C0)230/60-A-AB-CE	4102003608	230/1/60	350 x 500 x 450	19	16	350	3/4" M
COOL36(C1)230/60-A-AB-CE	4102003609	230/1/60	350 x 500 x 450	19	16	600	3/4" M
COOL51(C2)230/60-A-AB-CE	4102003610	230/1/60	350 x 500 x 450	19	16	850	3/4" M
COOL72(C3)230/60-A-AB-CE	4102003611	230/1/60	350 x 500 x 450	20	16	1200	3/4" M
COOL110(C4)230/60-A-AB-CE	4102003612	230/1/60	350 x 500 x 450	25	16	1825	3/4" M
COOL 180 (C6) 230/50 ABC	4102001849	230/1/50	370 x 500 x 764	44	16	3000	1" F
COOL 180 (C6) 230/60 CE ABC	4102001850	230/1/60	370 x 500 x 764	44	16	3000	1" F
COOL129(C5)230/50-A-AB-CE	4102003607	230/1/50	350 x 500 x 450	27	16	2150	3/4" M
COOL129(C5)230/60-A-AB-CE	4102003613	230/1/60	350 x 500 x 450	27	16	2150	3/4" M
COOL216(C7)230/50-A-AB-CE	4102005075	230/1/50	370 x 500 x 764	44	16	3600	1" F
COOL216(C7)230/60-A-AB-CE	4102005080	230/1/60	370 x 500 x 764	44	16	3600	1" F
COOL246(C7,5)230/50-A-AB-CE	4102005076	230/1/50	460 x 560 x 789	53	13	4100	1 1/2" F
COOL246(C7,5)230/60-A-AB-CE	4102005081	230/1/60	460 x 560 x 789	53	13	4100	1 1/2" F
COOL312(C8)230/50-A-AB-CE	4102005077	230/1/50	460 x 560 x 789	60	13	5200	1 1/2" F
COOL312(C8)230/60-A-AB-CE	4102005082	230/1/60	460 x 560 x 789	60	13	5200	1 1/2" F
COOL390(C9)230/50-A-AB-CE	4102005078	230/1/50	460 x 560 x 789	65	13	6500	1 1/2" F
COOL390(C9)230/60-A-AB-CE	4102005083	230/1/60	460 x 560 x 789	65	13	6500	1 1/2" F
COOL462(C10)230/50-A-AB-CE	4102005079	230/1/50	580 x 590 x 899	80	13	7700	1 1/2" F
COOL462(C10)230/60-A-AB-CE	4102005084	230/1/60	580 x 590 x 899	80	13	7700	1 1/2" F

Filters



ABAC
AIR COMPRESSORS

Filters

Offering filtration up to ISO Class 1 for oil and particulate, our line filters offer market-leading filtration with a long service interval and low total cost of ownership. Easy-access to the filter cartridges makes maintaining your compressed air system easier than ever before.

Pre-filters

Designed to clean particularly contaminated inlet air, these filters capture particulate down to 5 microns in size. This helps to protect and extend the life of downstream equipment, from dryers, to more sensitive filter elements or end application tooling.

190

Standard Filters

Our standard filters cover particulate and coalescent removal down to 0.1 micron and 0.01g/m³. With easy servicing access and durable filter cartridges, these filters are the perfect partner for everyday filtration needs.

191

Fine Filters

For more specific applications, we offer fine filtration grades to remove the majority of coalescent and particulate, suitable to reach ISO Class 3 for oil and particulate residues.

192

Activated Carbon Filters

ABAC activated carbon filters offer the latest filtration technology to reach ISO class 1 air, for the ultimate quality of compressed air.

193

Water Separators

It's crucial to protect your investment and avoid excessive servicing costs in particularly humid environments by fitting a water separator ahead of other air treatment solutions. Designed with fluid dynamics simulation, our water separators offer fantastic performance combined with minimal pressure drop.

194



FP

The ABAC FP line filter effectively removes contaminants from particularly demanding inlet air, with a filtration level down to 5µm.

Model	Part Number	l/min	KG	Max. work. pressure bar	Dimensions of inlet and outlet connections
FP 10 (G1/8) - AB	8102855049	180	0,25	16	G-1/8"
FP 25 (G1/4) - AB	8102855050	420	0,25	16	G-1/4"
FP 42 (G1/4) - AB	8102855051	720	0,6	16	G-1/4"
FP 54 (G3/8) - AB	8102855052	900	0,6	16	G-3/8"
FP 85 (G1/2) - AB	8102855053	1440	0,6	16	G-1/2"
FP 119 (G1/2) - AB	8102855054	1980	1,7	16	G-1/2"
FP 144 (G3/4) - AB	8102855055	2400	1,7	16	G-3/4"
FP 178 (G1) - AB	8102855056	2940	1,7	16	G-1"
FP 212 (G3/4) - AB	8102855057	3540	2	16	G-3/4"
FP 297 (G1) - AB	8102855058	4980	2	16	G-1"
FP 476 (G1 1/4) - AB	8102855059	7920	3	16	G-1 1/4"
FP 545 (G1 1/2) - AB	8102855060	9090	3	16	G-1 1/2"
FP 765 (G2) - AB	8102855061	12780	4,9	16	G-2"
FP 1189 (G2) - AB	8102855062	19800	5,5	16	G-2"
FP 1444 (G2 1/2) - AB	8102855063	24060	10,5	16	G-2 1/2"
FP 1529 (G3) - AB	8102855064	25500	10,5	16	G-3"
FP 2125 (G3) - AB	8102857000	35400	11,5	16	G-3"
FP 2550 (G3) - AB	8102857001	42480	12,5	16	G-3"

FG



The ABAC FG is the perfect upstream filter for most applications and most commonly specified when installing a dryer.

Model	Part Number	l/min	KG	Max. work. pressure bar	Dimensions of inlet and outlet connections
FG 10 (G1/8) - AB	8102855065	180	0,25	16	G-1/8"
FG 25 (G1/4) - AB	8102855066	420	0,25	16	G-1/4"
FG 42 (G1/4) - AB	8102855067	720	0,6	16	G-1/4"
FG 54 (G3/8) - AB	8102855068	900	0,6	16	G-3/8"
FG 85 (G1/2) - AB	8102855069	1440	0,6	16	G-1/2"
FG 119 (G1/2) - AB	8102855070	1980	1,7	16	G-1/2"
FG 144 (G3/4) - AB	8102855071	2400	1,7	16	G-3/4"
FG 178 (G1) - AB	8102855072	2940	1,7	16	G-1"
FG 212 (G3/4) - AB	8102855073	3540	2	16	G-3/4"
FG 297 (G1) - AB	8102855074	4980	2	16	G-1"
FG 476 (G1 1/4) - AB	8102855075	7920	3	16	G-1 1/4"
FG 545 (G1 1/2) - AB	8102855076	9090	3	16	G-1 1/2"
FG 765 (G2) - AB	8102855077	12780	4,9	16	G-2"
FG 1189 (G2) - AB	8102855078	19800	5,5	16	G-2"
FG 1444 (G2 1/2) - AB	8102855079	24060	10,5	16	G-2 1/2"
FG 1529 (G3) - AB	8102855080	25500	10,5	16	G-3"
FG 2125 (G3) - AB	8102857002	35400	11,5	16	G-3"
FG 2550 (G3) - AB	8102857003	42480	12,5	16	G-3"



FC

The FC is an effective partner to the FG and offers effective coalescent removal for most applications.

Model	Part Number	l/min	KG	Max. work. pressure bar	Dimensions of inlet and outlet connections
FC 10 (G1/8) - AB	8102855081	180	0,25	16	G-1/8"
FC 25 (G1/4) - AB	8102855082	420	0,25	16	G-1/4"
FC 42 (G1/4) - AB	8102855083	720	0,6	16	G-1/4"
FC 54 (G3/8) - AB	8102855084	900	0,6	16	G-3/8"
FC 85 (G1/2) - AB	8102855085	1440	0,6	16	G-1/2"
FC 119 (G1/2) - AB	8102855086	1980	1,7	16	G-1/2"
FC 144 (G3/4) - AB	8102855087	2400	1,7	16	G-3/4"
FC 178 (G1) - AB	8102855088	2940	1,7	16	G-1"
FC 212 (G3/4) - AB	8102855089	3540	2	16	G-3/4"
FC 297 (G1) - AB	8102855090	4980	2	16	G-1"
FC 476 (G1 1/4) - AB	8102855091	7920	3	16	G-1 1/4"
FC 545 (G1 1/2) - AB	8102855092	9090	3	16	G-1 1/2"
FC 765 (G2) - AB	8102855093	12780	4,9	16	G-2"
FC 1189 (G2) - AB	8102855094	19800	5,5	16	G-2"
FC 1444 (G2 1/2) - AB	8102855095	24060	10,5	16	G-2 1/2"
FC 1529 (G3) - AB	8102855096	25500	10,5	16	G-3"
FC 2125 (G3) - AB	8102857004	35400	11,5	16	G-3"
FC 2550 (G3) - AB	8102857005	42480	12,5	16	G-3"

FV

For extensive filtration, the FV is required to achieve ISO Class 1 filtration, down to 0.001 micron particulate.



Model	Part Number	l/min	KG	Max. work. pressure bar	Dimensions of inlet and outlet connections
FV 10 (G1/8) - AB	8102855097	180	0,25	20,7	G-1/8"
FV 25 (G1/4) - AB	8102855098	420	0,25	20,7	G-1/4"
FV 42 (G1/4) - AB	8102855099	720	0,6	20,7	G-1/4"
FV 54 (G3/8) - AB	8102855100	900	0,6	20,7	G-3/8"
FV 85 (G1/2) - AB	8102855101	1440	0,6	20,7	G-1/2"
FV 119 (G1/2) - AB	8102855102	1980	1,7	20,7	G-1/2"
FV 144 (G3/4) - AB	8102855103	2400	1,7	20,7	G-3/4"
FV 178 (G1) - AB	8102855104	2940	1,7	20,7	G-1"
FV 212 (G3/4) - AB	8102855105	3540	2	20,7	G-3/4"
FV 297 (G1) - AB	8102855106	4980	2	20,7	G-1"
FV 476 (G1 1/4) - AB	8102855107	7920	3	20,7	G-1 1/4"
FV 545 (G1 1/2) - AB	8102855108	9090	3	20,7	G-1 1/2"
FV 765 (G2) - AB	8102855109	12780	4,9	20,7	G-2"
FV 1189 (G2) - AB	8102855110	19800	5,5	20,7	G-2"
FV 1444 (G2 1/2) - AB	8102855111	24060	10,5	20,7	G-2 1/2"
FV 1529 (G3) - AB	8102855112	25500	10,5	20,7	G-3"
FV 2125 (G3) - AB	8102857006	35400	11,5	20,7	G-3"
FV 2550 (G3) - AB	8102857007	42480	12,5	20,7	G-3"

Water Separators



WS

ABAC water separators in the WS range are perfect partners to pre-treat extra humid air before processing with a dryer or other filters.

Model	Part Number	l/min	KG	Max. work. pressure bar	Dimensions of inlet and outlet connections
WS 10 (G1/8) AB	8102855113	168	0,25	16	G-1/8"
WS 25 (G1/4) AB	8102855114	414	0,25	16	G-1/4"
WS 42 (G1/4) AB	8102855115	702	0,6	16	G-1/4"
WS 59 (G3/8) AB	8102855116	984	0,6	16	G-3/8"
WS 85 (G1/2) AB	8102855117	1416	0,6	16	G-1/2"
WS 119 (G1/2) AB	8102855118	1986	1,7	16	G-1/2"
WS 212 (G3/4) AB	8102855119	3534	1,7	16	G-3/4"
WS 297 (G1) AB	8102855120	4950	1,7	16	G-1"
WS 476 (G1 1/4) AB	8102855121	7932	3	16	G-1 1/4"
WS 545 (G1 1/2) AB	8102855122	9084	3	16	G-1 1/2"
WS 1189 (G2) AB	8102855123	19818	4,9	16	G-2"
WS 1444 (G2 1/2) AB	8102855124	24066	8	16	G-2 1/2"
WS 2550 (G3) AB	8102855125	42498	8	16	G-3"



Air Distribution

Air. Anytime. Anywhere.

Calculating air pipework system dimensions

An efficient compressed air system needs to include a well-designed pipe network in order to minimise the loss of air pressure from the distribution network. ABAC can help you design a pipe system which suits your specific requirements in order to maximize efficiency.

Leaks in the air pipework system can generate high costs, so it's important to prevent them from happening. In smaller industrial air networks, the average leak rate is 5%, while in larger industrial air networks leakage can be between 10 - 15%, based on air consumption during production.

In order to plan a compressed air pipeline accurately, both the pipework dimensions and the materials it is constructed from need to be considered carefully, due to the potential risk of corrosion, which can result in high pressure losses.

Four simple steps to achieving the perfect compressed air pipework system:

- Select the right pipe system according to your compressed air requirements.**
- Choose a ring or stub line based on your space requirements:** A stub line is suitable for individual compressed air outlets and for bridging small distances. If several compressed air outlets need to be installed on different sides of a workspace, a ring line is recommended because the same pressure is delivered to all connection points in the network. Please refer to the tables on the following page.
- Select the correct pipeline fittings:** Resistance fittings are required for flowing compressed air systems and a substitute pipeline length must be included for each fitting. These lengths can be taken from the table on the following page. It is also important to consider the pipeline diameter already calculated in point 2 when selecting fittings.

Example:		Substitute pipe length	Nominal length
	2 angles \varnothing 28 mm	1.5 m	3.0 m
	5 T-pieces \varnothing 28 mm	2.0 m	10.0 m
	Total		13.4 m

- Calculate your pipeline diameter:** Add the nominal length of the pipeline from point 2 and the substitute length for fittings from point 3 to determine the total length. The total length can now be used to calculate the correct pipeline diameter to suit specific requirements, as illustrated in the tables on the following pages.

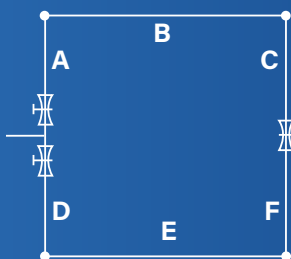

Compressed air distribution with closed ring line

For dimensioning the ring line, take half of the nominal length of the total ring line and the entire compressed air requirements into consideration:

Length A B C = 250 m,
Length D E F = 250 m
Half closed ring line length: 250 m

Design data for pipelines

Substitute pipeline lengths for fittings

Working overpressure 7 bar,

Δp (max.) 0.2 bar, flow speed (max.) 10 m/s

Fittings	Comparable with	3/8"	1/2"	3/4"	1"	1 1/4"	1 1/4"	1 1/2"	1 1/2"	2"	2 1/2"
Dia.	inner	12	14	18	24	28	32	38	38	50	63
Dia.	outer	15	18	22	28	32	40	40	50	63	80
Ball valve		0.1	0.2	0.3	0.4	0.5	0.5	0.6	0.6	0.7	0.8
Angle 45°		0.4	0.5	0.7	0.7	1.0	1.0	1.3	1.3	1.8	2.0
Angle 90°		0.7	1.0	1.3	1.5	2.0	2.0	2.5	2.5	3.5	4.0
T-piece		0.8	1.0	1.5	2.0	2.5	2.5	3.0	3.0	4.0	5.0
Reduction fitting 2d to d		0.4	0.5	0.5	0.6	0.7	0.7	0.8	0.8	1.0	1.5

Design data for pipelines

- The dimensions of a stub line: The total nominal length of the line and the total compressed air requirements
- The dimensions of a ring line: Half the nominal length of the line and the total compressed air requirements

Polyamide (PA) pipe/plug-in system 15-28 mm

Working overpressure 7 bar, Δp (max.) 0.2 bar,
flow speed (max.) 10 m/s

Compressed air flow rate	Length of the pipeline [m]														
	N[l/s]	N[l/min]	N[m ³ /min]	25	50	75	100	150	200	250	300	400	500	750	1.000
1,7	100	0,1	15	15	15	15	15	15	15	15	15	18	18	18	22
3,3	200	0,2	15	15	15	15	18	18	22	22	22	22	22	22	28
5,0	300	0,3	15	15	18	18	22	22	22	22	28	28	28	28	28
6,7	400	0,4	15	18	22	22	22	22	28	28	28	28	28	28	>28
8,3	500	0,5	18	22	22	22	22	28	28	28	28	28	28	>28	>28
12,5	750	0,8	22	22	22	28	28	28	28	>28	>28	>28	>28	>28	>28
16,7	1.000	1,0	22	28	28	28	28	>28	>28	>28	>28	>28	>28	>28	>28
25,0	1.500	1,5	28	28	28	>28	>28	>28	>28	>28	>28	>28	>28	>28	>28
33,3	2.000	2,0	28	>28	>28	>28	>28	>28	>28	>28	>28	>28	>28	>28	>28

Diameter > 28 mm - see AIRnet PF/Black series

Aluminium pipe/plug-in system 15-28 mm

Working overpressure 7 bar, Δp (max.) 0.2 bar,
flow speed (max.) 10 m/s

Compressed air flow rate	Length of the pipeline [m]														
	N[l/s]	N[l/min]	N[m ³ /min]	25	50	75	100	150	200	250	300	400	500	750	1.000
1,7	100	0,1	15	15	15	15	15	15	15	15	15	18	18	18	18
3,3	200	0,2	15	15	15	15	18	18	18	18	18	22	22	22	28
5,0	300	0,3	15	15	18	18	18	22	22	22	22	28	28	28	28
6,7	400	0,4	15	18	18	22	22	22	22	28	28	28	28	28	>28
8,3	500	0,5	18	18	22	22	22	28	28	28	28	28	28	>28	>28
12,5	750	0,8	18	22	22	28	28	28	28	28	28	>28	>28	>28	>28
16,7	1.000	1,0	22	28	28	28	28	28	>28	>28	>28	>28	>28	>28	>28
25,0	1.500	1,5	28	28	28	>28	>28	>28	>28	>28	>28	>28	>28	>28	>28
33,3	2.000	2,0	28	28	>28	>28	>28	>28	>28	>28	>28	>28	>28	>28	>28
50,0	3.000	3,0	28	>28	>28	>28	>28	>28	>28	>28	>28	>28	>28	>28	>28

Diameter > 28 mm - see AIRnet PF/Black series

Aluminium pipe/AIRnet 20-158 mm

Working overpressure 7 bar, Δp (max.) 0.2 bar,
flow speed (max.) 10 m/s

Compressed air flow rate	Length of the pipeline [m]												
	N[l/s]	N[l/min]	N[m ³ /min]	50	100	150	300	500	750	1.000	1.300	1.600	2.000
3	200	0,2	20	20	20	20	20	20	20	20	20	20	25
8	500	0,5	20	20	20	25	25	25	25	40	40	40	40
14	800	0,8	20	20	25	25	40	40	40	40	40	40	40
19	1.200	1,2	20	25	25	40	40	40	40	40	40	40	40
28	1.700	1,7	25	25	40	40	40	40	40	40	50	50	50
42	2.500	2,5	25	40	40	40	40	40	50	50	50	50	63
69	4.000	4	40	40	40	50	50	50	63	63	63	63	63
97	6.000	6	40	40	50	50	50	63	63	63	80	80	80
139	8.000	8	40	50	50	63	63	63	80	80	80	80	100
208	13.000	13	50	63	63	63	80	80	100	100	100	100	100
278	17.000	17	50	63	63	80	80	100	100	100	100	100	158
347	21.000	21	63	63	80	80	100	100	100	100	158	158	158
417	25.000	25	63	80	80	100	100	100	100	158	158	158	158
486	29.000	29	63	80	80	100	100	100	158	158	158	158	158
556	33.000	33	63	80	80	100	100	158	158	158	158	158	158
694	42.000	42	80	80	100	158	158	158	158	158	158	158	158
833	50.000	50	80	100	100	158	158	158	158	158	158	158	158
972	58.000	58	80	100	100	158	158	158	158	158	158	200	200
1.111	67.000	67	100	100	158	158	158	158	158	158	200	200	200
1.250	75.000	75	100	158	158	158	158	158	158	200	200	200	200
1.389	83.000	83	100	158	158	158	158	158	158	200	200	200	200
1.528	92.000	92	100	158	158	158	158	158	200	200	200	200	200
1.667	100.000	100	100	158	158	158	158	158	200	200	200	200	200

Diameter > 158 mm not in supply range

Socket system 15-28 mm

Laid, extended and modified in an instant



Huge time savings with simple, quick assembly of pipes and connectors

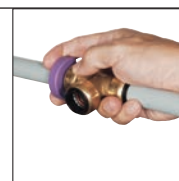

Flexible system for simple release and reconnection

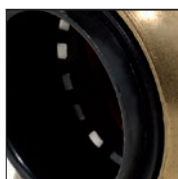

Large number of stainless steel retaining claws hold the pipe securely in the plug connectors

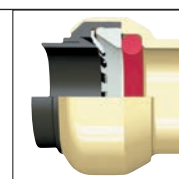

Resistant O-ring ensures complete impermeability, even if the air contains oil

For small and medium-sized workshops: Lay pipelines quickly and easily with a few hand movements with the AIRnet pipe system, and extend or modify existing pipelines. The flexible plug-in system offers a wide selection of different connectors.

The Click-it plug connectors

- 1 - The stainless steel retaining claw provides a force lock for retaining the pipe securely
- 2 - Oil-resistant O-ring for complete impermeability, even with oil containing compressed air
- 3 - Spacer washer for centring the pipe in the fitting exactly

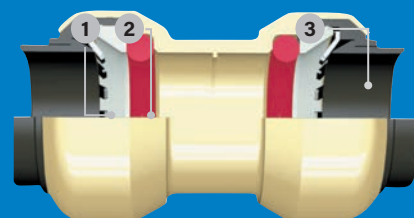

Innovative pipe system

It is not unusual for compressed air pipework systems to be changed regularly. The innovative 'click it' pipework makes pipework changes as easy as possible, enabling connectors to be detached for reuse without causing any damage to the pipe or connector.

1

Cut the pipe to the correct size:

Achieve millimetre accurate cuts with ABAC pipe shears.



2

Deburr and chamfer the pipework:

Ensure the pipework and fittings connect properly.



3

Join the pipes using plug connectors:

When inserted as far as the stop, the pipe is completely airtight, enabling fast and simple installation.



4

Quick disassembly:

The clip is pressed against the connector and the pipe can be removed from the connector.





Polyamide pipes

- ▶ Free of silicone
- ▶ Black UV-resistant pipes, suitable for outdoor installation
- ▶ Polyamide (PA) for greater flexibility
- ▶ Pipe shears cut pipelines to length in a single cut
- ▶ Rubber handle grip

MODEL	Part number	System dia.				Length (m)	Packaging unit (pc.)	Description
		15	18	22	28			
PA Pipe D15 25m	2813110000	●				25	1	Rolled pipe, grey ¹⁾
PA Pipe D18 25m	2813210000		●			25	1	
PA Pipe D22 25m	2813310000			●		25	1	
PA Pipe D28 25m	2813410000				●	25	1	
PA Pipe D15 5,7m	2813100000	●				5,7	1	Lengths of pipe, grey ²⁾
PA Pipe D15 10m	2813120000	●				10	1	
PA Pipe D18 5,7m	2813200000		●			5,7	1	
PA Pipe D18 10m	2813220000		●			10	1	
PA Pipe D22 5,7m	2813300000			●		5,7	1	
PA Pipe D28 5,7m	2813400000				●	5,7	1	
PA UV Pipe D15 25m	2813130000	●				25	1	Rolled pipe, black ¹⁾
PA UV Pipe D18 25m	2813230000		●			25	1	
PA UV Pipe D22 25m	2813330000			●		25	1	
PA UV Pipe D22 5,7m	2813320000			●		5,7	1	

1) Max. operating pressure for rolled pipe: 14 bar at -20 °C to ≤ +20 °C; 11 bar at +20 °C to ≤ +50 °C

2) Max. operating pressure for lengths of pipe: 16 bar at -20 °C to ≤ +20 °C; 11 bar at +20 °C to ≤ +50 °C



Special aluminium alloy pipes

- ▶ UV-resistant and suitable for outdoor installation
- ▶ Free of silicone
- ▶ Ideal as a main pipe as lightweight, stable and easy to lay using few pipe clips
- ▶ Low linear expansion ideal for large fluctuations in temperature
- ▶ Pipe protected by outer coating

MODEL	Part number	System dia.				Length (m)	Packaging unit (pc.)	Description
		15	18	22	28			
AL Pipe D15 5,7m	2813140000	●				5,7	2	Lengths of pipe, grey ¹⁾
AL Pipe D18 5,7m	2813240000		●			5,7	1	
AL Pipe D22 5,7m	2813340000			●		5,7	1	
AL Pipe D28 5,7m	2813440000				●	5,7	1	

1) Max. operating pressure: 16 bar at -20 °C to ≤ +50 °C



Click-it brass plug connector

- ▶ Material: Brass
- ▶ Free of silicone
- ▶ Max. operating pressure: 16 bar at -20 °C to ≤ +50 °C
- ▶ Simple, quick assembly for huge time savings
- ▶ Flexible system for simple release and reconnection
- ▶ Resistant O-ring made from NBR ensures complete impermeability, even if the air contains oil
- ▶ Large number of stainless steel retaining claws hold the pipe securely in the plug connectors

MODEL	Part number	System dia.				Packaging unit (pc.)	Description	
		15	18	22	28			
Nipple socket D15 1/2 ISO7R m	2813101780	●				5	Straight male push-in connection	
Nipple socket D18 3/4 ISO7R m	2813211780		●			5		
Nipple socket D18 1/2 ISO7R m	2813201780		●			5		
Nipple socket D22 3/4 ISO7R m	2813311780			●		5		
Nipple socket D22 1/2 ISO7R m	2813301780			●		5		
Nipple socket D28 1 ISO7R m	2813421780				●	5	Straight female push-in connection	
Nipple socket D15 1/2 ISO228 f	2813101980	●				5		
Nipple socket D18 1/2 ISO228 f	2813201980		●			5		
Nipple socket D18 3/4 ISO228 f	2813211980		●			5		
Nipple socket D22 1/2 ISO228 f	2813301980			●		5		
Nipple socket D22 3/4 ISO228 f	2813311980			●		5	Straight push-in connection	
Nipple socket D28 1 ISO228 f	2813421980				●	5		
Equal socket D15	2813100280	●				5		
Equal socket D18	2813200280		●			5		
Equal socket D22	2813300280			●		5		
Equal socket D28	2813400280				●	5	Right-angle plug connector 90°	
90 Deg Elbow D15	2813100380	●				5		
90 Deg Elbow D18	2813200380		●			5		
90 Deg Elbow D22	2813300380			●		5		
90 Deg Elbow D28	2813400380				●	5		
45 Deg Elbow D15	2813100480	●				2	Angle plug connector 45°	
45 Deg Elbow D18	2813200480		●			2		
45 Deg Elbow D22	2813300480			●		2		
45 Deg Elbow D28	2813400480				●	2		
90 Deg Elbow D15-1/2 ISO7R m	2813100381	●				2		
90 Deg Elbow D18-1/2 ISO7R m	2813200381		●			2		
90 Deg Elbow D22-3/4 ISO7R m	2813310381			●		2		
90 Deg Elbow D28-1 ISO7R m	2813420381				●	2		
Equal tee D15	2813100580	●				5	T-branch push-in connection	
Equal tee D18	2813200580		●			5		
Equal tee D22	2813300580			●		5		
Equal tee D28	2813400580				●	5		
Reduction tee D22 D15 D22	2813310780	●				2		
Reduction tee D22 D18 D22	2813320780		●			2		
Reduction tee D28 D22 D22	2813430781			●		2		
Reduction tee D28 D18 D28	2813420780		●			2		
Reduction tee D28 D22 D28	2813430780			●		2		
Pipe end adapter D22-D15	2813316280	●				2		
Pipe end adapter D22-D18	2813326280		●			2		
Pipe end adapter D28-D18	2813426280		●			2		
Pipe end adapter D28-D22	2813436280			●		2		
Sliding equal socket D15	2813100281	●				2	Sliding sleeve	
Sliding equal socket D18	2813200281		●			2		
Sliding equal socket D22	2813300281			●		2		
Sliding equal socket D28	2813400281				●	2		
End cap D15	2813100680	●				2	Blind cap	
End cap D18	2813200680		●			2		
End cap D22	2813300680			●		2		
End cap D28	2813400680				●	2		
Threaded ad. D15-1/2 ISO7R m	2813101300	●				2	Connecting adapter Please note: it is mandatory to insert a notch into the connecting piece with the all-purpose tool 2813024000!	
Threaded ad. D18-1/2 ISO7R m	2813201300		●			2		
Threaded ad. D18-3/4 ISO7R m	2813211300		●			2		
Threaded ad. D22-1/2 ISO7R m	2813301300			●		2		
Threaded ad. D22-3/4 ISO7R m	2813311300			●		2		
Threaded ad. D28-1 ISO7R m	2813421300				●	2		



Air shut-off valve

- ▶ NBR seal
- ▶ Simple shut-off function ensures a high degree of energy efficiency and safety of the supply network
- ▶ For shutting off individual areas of a stub, ring or outlet line
- ▶ Plug connector not preassembled

MODEL	Part number	System dia.			
		15	18	22	28
Ball valve D15 ¹⁾	2813105180	●			
Ball valve D18 ¹⁾	2813205180		●		
Ball valve D22 ¹⁾	2813305180			●	
Ball valve D28 ¹⁾	2813405180				●

1) Max. operating pressure: 16 bar at -20 °C to +50 °C

Assembly aids

MODEL	Part number	System dia.				Packaging unit (pc.)	Description	
		15	18	22	28			
Pipe clip D15	2813102200	●				25	Pipe clips	
Pipe clip D18	2813202200		●			25		
Pipe clip D22	2813302200			●		25		
Pipe clip D28	2813402200				●	25		
Pipe clamp D15-D18	2813122200	●	●			25	Pipe clamps	
Pipe clamp D22	2813332200			●		25		
Pipe clamp D28	2813442200				●	25		
Hanger bolt for pipe clamps	2813002200					25	Hanger bolt for pipe clamps	
Disassembly pliers D15	2813102800	●				1	Disassembly pliers	
Disassembly pliers D18	2813202800		●			1		
Disassembly pliers D22	2813302800			●		1		
Disassembly pliers D28	2813402800				●	1		
Disassembly clip D15	2813112800	●				5	Disassembly clip	
Disassembly clip D18	2813222800		●			5		
Disassembly clip D22	2813332800			●		5		
Disassembly clip D28	2813442800				●	5		



Marking and deburring tool

- For chamfering and deburring aluminium pipes, marking insertion depths and notching indentations on hard surfaces

MODEL	Part number
Marking and deburring tool	2813024000



Shear

- For cutting PA pipes, max. dia. 28 mm (with reversible blade)
- With impact function

MODEL	Part number
Shear	2813004000
2 spare blades shear	2813014000



Pipe cutter

- For aluminium and stainless steel pipes, dia. 15-32 mm

MODEL	Part number
Pipe Cutter D32	2813034000
Pipe Cutter D32 cutting wheel	2813044000



Deburring tool

- For deburring plastic, aluminium and stainless steel pipes
- For inner and outer diameters up to 35 mm

MODEL	Part number
Deburring tool D35	2813054000



Deburring blade

- For deburring the inner diameter of aluminium pipes

MODEL	Part number
Deburring blade	2813064000



Anti-friction agent

- For easy installation of compressed air pipes
- Free of silicone

MODEL	Part number
Anti-friction agent	2813074000

Pipe sockets 15-22 mm

Innovative and flexible - for greater economic efficiency

Safety

Well designed cooling flow for reduced temperature and longer lifetime



Install perfect compressed air outlets in the pipe system for each workplace. Versatile pipe sockets are fully compatible with the AIRnet pipe system and various attachment parts and can be extended by fitting additional outlet components.

A flexible system with unimagined possibilities

Hardly any other pipe system is changed as often as a compressed air network. That's no problem with the 'click it' system. The connection can be detached easily without causing damage to the pipe or connector. All parts can then be reused.

Long-lasting and permanently tight thanks to metal thread inserts

Flexible use as an air inlet, air passage and air junction box – some even with rear outlet

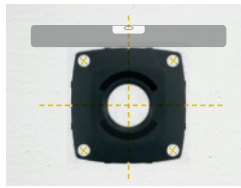

Uncomplicated assembly
The screens of the Basic sockets serve additionally as drilling templates and spirit level supports.



Economical
Continued use of existing basic sockets for extensions

Simple assembly
by removing the screens from the Basic sockets and screwing on the top sockets

Extra versatility
The top sockets are available in three different models

Protection of lines
The air outlet is directed downwards to avoid bending hoses

Model overview:



MODEL	Part number	Outlets	Thread
Socket Box 2x1/2	2813002580	2	1/2"
Socket Box 3x1/2	2813002581	3	1/2"
Socket Box 4x1/2	2813002582	4	1/2"
Socket Box 6x1/2	2813002583	6	1/2"
Socket Box Alu 4x3/4 - 1/2	2813002505	4/1	3/4" / 1/2"
Socket Box Top 2x1/2	2813002680	2	1/2"
Socket Box Top 3x1/2	2813002681	3	1/2"
Socket Box Top 4x1/2	2813002682	4	1/2"

Five Basic sockets with two to six air outlets can be combined with three top sockets with two to four outlets.

If one basis socket is initially sufficient, the screen included in the delivery is clipped onto it. If your socket requirements increase, the system can be extended at any time by adding a top socket without having to disassemble the basis socket.

Further pipe sockets can be connected without any problem at the side via a short pipeline or a double nipple. If an outlet is no longer needed, simply lock it with a locking screw.

Midi pipe sockets

Midi System for restricted spatial conditions.

Assemble the pipe sockets exactly as you need them.

Basic sockets are available for each system. These can then be individually fitted with the required outflows and elements.



Socket Box Mini 3/8 - 1/2



Socket Box Mini 2x3/8 - 1/2



Socket Box Mini 3/8 - 2x1/2



Midi pipe sockets

- ▶ For wall and ceiling mounting
- ▶ Max. operating pressure: 16 bar at -20 °C to ≤ +50 °C
- ▶ Extremely versatile, with input blocks, through blocks and dead-end distribution blocks

MODEL	Part number	Description
Socket Box Mini 3/8 - 1/2	2813002700	
Socket Box Mini 2x3/8 - 1/2	2813002701	Midi dead-end distribution block
Socket Box Mini 3/8 - 2x1/2	2813002702	



Basic pipe sockets

- ▶ For wall and ceiling mounting
- ▶ Including removable screen, which can be used as a drilling template
- ▶ Max. operating pressure: 16 bar at -20 °C to ≤ +50 °C
- ▶ Basic sockets with integrated plug connectors for simple connection of the pipeline

MODEL	Part number	Description
Socket Box 2x1/2	2813002580	
Socket Box 3x1/2	2813002581	Basic pipe socket G1/2"i dimensions without screen LxWxH: 85x85x45 mm, with screen 48 mm high
Socket Box 4x1/2	2813002582	
Socket Box 6x1/2	2813002583	
Socket Box Alu 4x3/4 - 1/2	2813002505	Basic pipe socket G1" Dimensions LxWxH: 90x90x53 mm



Top pipe sockets

- ▶ Top socket including fastening material and sealing
- ▶ Max. operating pressure: 16 bar at -20 °C to ≤ +50 °C
- ▶ Exclusively for fitting to a Basic socket

MODEL	Part number	Description
Socket Box Top 2x1/2	2813002680	
Socket Box Top 3x1/2	2813002681	Pipe socket Top G1/2"
Socket Box Top 4x1/2	2813002682	

Hoses and workshop equipment

For a perfectly organised workplace



For private use and professional workshop applications – hard-wearing fabric hoses, flexible Super-Flex hoses or durable polyurethane hoses for every application. For optimal workplace organisation and ergonomic work – hose rewinders, power and air supply units and tractions.



2813930010
„oil-resistant“

2813930003

PVC hose with fabric inlay

- ▶ Max. operating pressure 15 bar at 20 °C
- ▶ Particularly resistant against compressed air containing oil

MODEL	Part number	With quick-action coupling and plug nipple	Max. pressure (bar)	Outer dia. (mm)	Inside dia. (mm)	Length (m)
H PVC-QRC-E-15bar 11-6/5m	2813930000	EURO profile	15	11	6	5
H PVC-QRC-U-15bar 11-6/5m	2813930005	UNIVERSAL profile	15	11	6	5
H PVC-QRC-E-15bar 11-6/10m	2813930001	EURO profile	15	11	6	10
H PVC-QRC-U-15bar 11-6/10m	2813930006	UNIVERSAL profile	15	11	6	10
H PVC-15bar 11-6/25m	2813930015		15	11	6	25
H PVC-15bar 11-6/50m	2813930016		15	11	6	50
H PVC-QRC-E-15bar 15-9/5m	2813930002	EURO profile	15	15	9	5
H PVC-QRC-U-15bar 15-9/5m	2813930007	UNIVERSAL profile	15	15	9	5
H PVC-QRC-E-15bar 15-9/10m	2813930003	EURO profile	15	15	9	10
H PVC-QRC-U-15bar 15-9/10m	2813930008	UNIVERSAL profile	15	15	9	10
H PVC-15bar 15-9/25m	2813930017		15	15	9	25
H PVC-15bar 15-9/50m	2813930018		15	15	9	50
H PVC-QRC-E-15bar 18-13/10m	2813930004	EURO profile	15	18	13	10
H PVC-QRC-U-15bar 18-13/10m	2813930009	UNIVERSAL profile	15	18	13	10
H PVC-15bar 18-13/25m	2813930019		15	18	13	25
H PVC-15bar 18-13/50m	2813930020		15	18	13	50
H PVC-QRC-E-OR-15bar 15-9/10m	2813930010	EURO profile	15	15	9	10
H PVC-OR-15bar 15-9/25m	2813930021		15	15	9	25



Super-Flex hose

- ▶ PVC hose with fabric inlay
- ▶ Max. operating pressure 15 bar at 20 °C
- ▶ Reinforced external material for greater resistance to ageing and protection against compressed air containing oil
- ▶ Extremely flexible, even at low temperatures

MODEL	Part number	With quick-action coupling and plug nipple	Max. pressure (bar)	Outer dia. (mm)	Inside dia. (mm)	Length (m)
H PVC-QRC-E-SF-15bar 11-6/5m	2813930011	EURO profile	15	11	6,3	5
H PVC-QRC-E-SF-15bar 11-6/10m	2813930012	EURO profile	15	11	6,3	10
H PVC-SF-15bar 11-6/25m	2813930022		15	11	6,3	25
H PVC-SF-15bar 11-6/50m	2813930023		15	11	6,3	50
H PVC-QRC-E-SF-15bar 15-10/5m	2813930013	EURO profile	15	15,5	10	5
H PVC-QRC-E-SF-15bar 15-10/10m	2813930014	EURO profile	15	15,5	10	10
H PVC-SF-15bar 15-10/25m	2813930024		15	15,5	10	25
H PVC-SF-15bar 15-10/50m	2813930025		15	15,5	10	50
H PVC-SF-15bar 19-13/25m	2813930026		15	19	12,7	25
H PVC-SF-15bar 19-13/50m	2813930027		15	19	12,7	50
H PVC-SF-15bar 27-19/25m	2813930028		15	27	19	25
H PVC-SF-15bar 27-19/50m	2813930029		15	27	19	50



High-pressure hose version

- ▶ PVC hose with reinforced polyester threads, smooth hose core and UV- resistant outer lining
- ▶ Max. operating pressure 40 bar at 20 °C
- ▶ High-pressure version for pressure up to 40 bar
- ▶ Particularly suitable for connecting pneumatic tools outdoors
- ▶ Extremely flexible, even at low temperatures
- ▶ For temperature range from -15 °C to +60 °C

MODEL	Part number	Max. pressure (bar)	Outer dia.(mm)	Inside dia.(mm)	Length (m)
H PVC-SF-40bar 16-9/50m	2813930030	40	16	9	50
H PVC-SF-40bar 21-13/50m	2813930031	40	21	13	50



Polyamide spiral hose

- ▶ Connections with swivel joints (except 2813940000)
- ▶ With rotary quick-action coupling (only QRC) and plug nipple, ready for immediate use
- ▶ Bend protection at the spiral hose ends for an extended service life and constant air flow
- ▶ Particularly suitable for tractions due to high reset force

MODEL	Part number	With quick-action coupling and plug nipple	Max. pressure (bar)	Outer dia. (mm)	Inside dia. (mm)	Working length (m)	Stretched length (m)
SH PA-QRC-E-8bar 8-6/5m	2813940000	EURO profile	8	8	6	2,5	5
SH PA-QRC-E-8bar 8-6/7,5m	2813940001	EURO profile	8	8	6	4	7,5
SH PA-QRC-E-8bar 8-6/15m	2813940002	EURO profile	8	8	6	8	15
SH PA-QRC-U-8bar 8-6/5m	2813940004	UNIVERSAL profile	8	8	6	2,5	5
SH PA-QRC-U-8bar 8-6/10m	2813940005	UNIVERSAL profile	8	8	6	6	7,5
SH PA-QRC-U-8bar 8-6/15m	2813940006	UNIVERSAL profile	8	8	6	8	15
SH PA-BJ-8bar 8-6/5m	2813940007	BAYONET profile	8	8	6	2,5	5
SH PA-BJ-8bar 8-6/10m	2813940008	BAYONET profile	8	8	6	6	7,5
SH PA-BJ-8bar 8-6/15m	2813940009	BAYONET profile	8	8	6	8	15
SH PA-QRC-E-8bar 10-8/10m	2813940003	EURO profile	8	10	8	6	10



Polyurethane spiral hose

- ▶ Connections with swivel joints
- ▶ With rotary quick-action coupling (EURO profile) and plug nipple, ready for immediate use
- ▶ Bend protection at the spiral hose ends for an extended service life and constant air flow
- ▶ Small winding diameter saves space
- ▶ Particularly abrasion-resistant and very resilient
- ▶ No remaining cross-section reductions upon bending

MODEL	Part number	With quick-action coupling and plug nipple	Max. pressure (bar)	Outer dia. (mm)	Inside dia. (mm)	Working length (m)	Stretched length (m)
SH PUR-QRC-E-8bar 10-6,5/6m	2813940010	EURO profile	8	10	6,5	4,8	6
SH PUR-QRC-E-8bar 10-6,5/7,5m	2813940011	EURO profile	8	10	6,5	6	7,5
SH PUR-8bar 10-6,5/7,5m	2813940014		8	10	6,5	6	7,5
SH PUR-QRC-E-8bar 12-8/6m	2813940012	EURO profile	8	12	8	4,8	6
SH PUR-QRC-E-8bar 12-8/7,5m	2813940013	EURO profile	8	12	8	6	7,5
SH PUR-8bar 12-8/7,5m	2813940015		8	12	8	6	7,5
SH PUR-8bar 16-10/5m	2813940016		8	16	10	2,5	5
SH PUR-8bar 16-10/10m	2813940017		8	16	10	6	10



Traction

- ▶ Compact, with robust aluminium housing
- ▶ Rubber buffer at the end
- ▶ For all types of portable devices and tools
- ▶ Fully fitted with safety cable, terminal block and snap hook
- ▶ High degree of flexibility because the spring tension on the housing can be used to set and adjust the required load capacity

MODEL	Part number	Carrying power (kg)	Stroke length (m)	Weight (kg)
EQ SST-0,4-1,0kg	2813960000	1	1,6	0,63
EQ SST-1,0-2,0kg	2813960001	2	1,6	0,67
EQ SST-2,0-3,0kg	2813960002	3	1,6	0,79
EQ SST-2,0-4,0kg	2813960003	4	2,5	2,85
EQ SST-4,0-6,0kg	2813960004	6	2,5	3
EQ SST-6,0-8,0kg	2813960005	8	2,5	3,1



Hose retractor, automatic

- ▶ Abrasion-resistant, flexible air hose with antikink spring and hose locking device
- ▶ Locking function can be deactivated
- ▶ Plastic housing
- ▶ With durable rolling mechanism for daily use in trade and the industry
- ▶ Fully fitted with quick-action coupling and long connection hose with plug nipple, ready to connect
- ▶ Flexible use with large swivel range
- ▶ Wall mounting

MODEL	Part number	Max. pressure (bar)	Outer dia (mm)	Inside dia (mm)	Extendable length (m)	Weight (kg)
HR PVC-QRC-U-A-15bar 12-8/10m	2813950004	15	12	8	10	4
HR PVC-QRC-U-A-15bar 12-8/15m	2813950005	15	12	8	15	7,3
HR PVC-QRC-U-A-15bar 14-10/15m	2813950006	15	14	10	15	8,8
HR PVC-QRC-U-A-15bar 18-13/15m	2813950007	15	17,5	12,5	15	10,5



Accessories for hose rewriter, automatic

- ▶ More safety by slowing down the rewinding hose

MODEL	Part number	Accessories
HR B 18-13/15	2813950008	for HR PVC-QRC-U-A-15bar 18-13/15m (2813950007)



Hose rewriter, automatic

- ▶ With robust metal housing
- ▶ With protected quick-action coupling
- ▶ Abrasion-resistant, flexible air hose with antikink spring and hose locking device
- ▶ Fully fitted with quick-action coupling and long connection hose with plug nipple, ready to connect
- ▶ Flexible use with large swivel range greater than 180°
- ▶ For wall and ceiling mounting

MODEL	Part number	Max. pressure (bar)	Outer dia. (mm)	Inside dia. (mm)	Extendable length (m)	Weight (kg)
H PVC-QRC-E-SF-15bar 11-6/5m	2813950002	15	12	8	9	5
H PVC-QRC-E-SF-15bar 11-6/10m	2813950003	15	12	8	15	6



Hose rewriter, manual

- ▶ Shock-resistant plastic housing
- ▶ Large work radius thanks to 20 m hose
- ▶ Axial connection - this way the hose can also be wound and unwound during operation
- ▶ Flexible PVC hose with fabric inlay

MODEL	Part number	Max. pressure (bar)	Outer dia. (mm)	Inside dia. (mm)	Extendable length (m)	Weight (kg)
HR PVC-QRC-U-M-15bar 15-9/20m	2813950000	15	15	9	20	3.9

Connecting & joining technology

User-friendly and safe

For all connections on tools, hoses and machines – from the simple nipple to the more complex safety quick-action coupling.



Steel safety quick-release couplings

- ▶ Eurostandard profile with nominal width of 7.6 for extremely high air flow rate
- ▶ Max. operating pressure 16 bar
- ▶ Free of silicone
- ▶ Safe working because the hose is not ejected when disconnected (whiplash effect), DIN EN ISO 4414 and DIN EN 983
- ▶ Hardened galvanised steel for an extended service life
- ▶ Low coupling force for easy coupling

MODEL *	Part number	Packaging unit (pc.)	Description
C QRC-SF-E-1/4"m	2813910018	5	Safety quick-release couplings with external thread
C QRC-SF-E-3/8"m	2813910019	5	
C QRC-SF-E-1/2"m	2813910020	5	
C QRC-SF-E-1/4"f	2813910021	5	Safety quick-release couplings with internal thread
C QRC-SF-E-3/8"f	2813910022	5	
C QRC-SF-E-1/2"f	2813910023	5	
C QRC-SF-E-6mm	2813910024	5	Safety quick-release couplings hose nozzle
C QRC-SF-E-9mm	2813910025	5	
C QRC-SF-E-13mm	2813910026	5	



Steel quick-release couplings with external thread

- ▶ Eurostandard profile with nominal width of 7.6 for extremely high air flow rate
- ▶ Max. operating pressure 16 bar
- ▶ Free of silicone
- ▶ Hardened galvanised steel for an extended service life
- ▶ Low coupling force for easy coupling

MODEL *	Part number	Packaging unit (pc.)	Description
C QRC-S-E-1/4"m	2813910009	5	Quick-release couplings with external thread
C QRC-S-E-3/8"m	2813910010	5	
C QRC-S-E-1/2"m	2813910011	5	
C QRC-S-E-1/4"f	2813910012	5	Quick-release couplings with internal thread
C QRC-S-E-3/8"f	2813910013	5	
C QRC-S-E-1/2"f	2813910014	5	
C QRC-S-E-6mm	2813910015	5	Quick-release couplings with hose nozzle
C QRC-S-E-9mm	2813910016	5	
C QRC-S-E-13mm	2813910017	5	

* Minimum order quantity for specialist dealers: 5 units

Tip: only use steel quick-release couplings in conjunction with hardened steel plug nipples



Steel plug nipple

- ▶ Eurostandard profile with nominal width of 7.6 for extremely high air flow rate
- ▶ Specially designed for use with steel quick-release couplings
- ▶ Hardened galvanised steel for an extended service life

MODEL *	Part number	Packaging unit (pc.)	Description
C PN-S-E-1/4"m	2813910000	5	Steel plug nipple with external thread
C PN-S-E-3/8"m	2813910001	5	
C PN-S-E-1/2"m	2813910002	5	
C PN-S-E-1/4"f	2813910003	5	Steel plug nipple with internal thread
C PN-S-E-3/8"f	2813910004	5	
C PN-S-E-1/2"f	2813910005	5	
C PN-S-E-6mm	2813910006	5	Steel plug nipple with hose nozzle
C PN-S-E-9mm	2813910007	5	
C PN-S-E-13mm	2813910008	5	

* Minimum order quantity for specialist dealers: 5 units



Brass quick-release couplings Euro profile

- ▶ European standard profile
- ▶ NW 7.2
- ▶ Material: Brass

MODEL	Part number	Packaging unit (pc.)	Description
C QRC-E-1/4"m	2813910027	10	Quick-release couplings with external thread
C QRC-E-3/8"m	2813910028	10	
C QRC-E-1/2"m	2813910029	10	
C QRC-E-1/4"f	2813910030	10	Quick-release couplings with internal thread
C QRC-E-3/8"f	2813910031	10	
C QRC-E-1/2"f	2813910032	10	
C QRC-E-6mm	2813910033	10	Quick-release couplings with hose nozzle
C QRC-E-9mm	2813910034	10	
C QRC-E-13mm	2813910035	10	
C 2QRC-E-3/8"f	2813910036	2	Distributor with quick-release couplings
C 3QRC-E-3/8"f	2813910037	2	

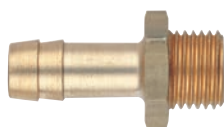

Hose nozzles

- ▶ Material: Brass

MODEL	Part number	Packaging unit (pc.)	Description
C HN-U-1/4"m x 6mm	2813910054	5	Hose nozzle with external thread
C HN-U-1/4"m x 9mm	2813910055	10	
C HN-U-3/8"m x 6mm	2813910056	5	
C HN-U-3/8"m x 9mm	2813910057	10	
C HN-U-3/8"m x 13mm	2813910058	10	
C HN-U-1/2"m x 6mm	2813910059	3	
C HN-U-1/2"m x 9mm	2813910060	10	Hose nozzle with internal thread
C HN-U-1/2"m x 13mm	2813910061	10	
C HN-U-1/4"f x 6mm	2813910062	10	
C HN-U-1/4"f x 9mm	2813910063	5	
C HN-U-3/8"f x 6mm	2813910064	10	
C HN-U-3/8"f x 9mm	2813910065	10	
C HN-U-1/2"f x 9mm	2813910066	10	Hose coupling
C HN-U-1/2"f x 13mm	2813910067	10	
C HOC-U-6mm	2813910068	2	
C HOC-U-6mm	2813910069	2	



Hose clamps

- ▶ Steel
- ▶ Galvanised and polished with 2 profiled lugs
- ▶ Range: 7 mm

MODEL	Part number	Packaging unit (pc.)
C HC-U-11-13mm	2813910047	10
C HC-U-13-15mm	2813910048	10
C HC-U-15-18mm	2813910049	10



Screw clamps

- ▶ Steel, polished and galvanised
- ▶ Range: 9 mm
- ▶ Screw thread with Phillips screw AF 7 mm

MODEL	Part number	Packaging unit (pc.)
C SC-U-10-16mm	2813910050	10
C SC-U-12-20mm	2813910051	10
C SC-U-16-25mm	2813910052	10
C SC-U-20-32mm	2813910053	10



Double nipple

MODEL	Part number	Packaging unit (pc.)	Material	Thread
C DN-U-1/4"m x 1/8"m	2813910070	5	Galvanised steel	With internal cone
C DN-U-1/4"m x 1/4"m	2813910071	5	Galvanised steel	With internal cone
C DN-U-3/8"m x 3/8"m	2813910073	5	Galvanised steel	With internal cone
C DN-U-1/2"m x 1/2"m	2813910075	5	Galvanised steel	With internal cone
C DN-U-3/8"m x 1/4"m	2813910072	5	Galvanised steel	With internal cone
C DN-U-1/2"m x 3/8"m	2813910074	5	Galvanised steel	With internal cone



Reduction fittings

MODEL	Part number	Packaging unit (pc.)	Material	Thread
C RE-U-1/4"m x 1/8"m	2813910076	5	Brass	With external and internal thread
C RE-U-3/8"m x 1/4"m	2813910077	5	Brass	With external and internal thread
C RE-U-1/2"m x 3/8"m	2813910078	5	Brass	With external and internal thread



Reducing nipple

MODEL	Part number	Packaging unit (pc.)	Material	Thread
C RN-U-1/4"m x 3/8"m	2813910079	10	Brass	With external and internal thread
C RN-U-3/8"m x 1/2"m	2813910080	10	Brass	With external and internal thread



Sleeves

MODEL	Part number	Packaging unit (pc.)	Material
C MU-1/4"m	2813910081	10	Brass
C MU-3/8"m	2813910082	10	Brass
C MU-1/2"m	2813910083	10	Brass

Maintenance units

Excellent air quality for every application

Achieve maximum compressed air quality and outstanding working results with our filters and maintenance units – from prefilters and microfilters through to activated carbon filters.



Pressure reducer

- ▶ With lockable adjustment button
- ▶ Regulation range 0-12 bar
- ▶ Standard features include: pressure gauge
- ▶ Pressure regulator with piston for high operational reliability
- ▶ High stability of adjusting pressure, even if the input pressure or the flow rate changes
- ▶ Assembly independent of flow direction thanks to double-sided connection option for pressure gauge

MODEL	Part number	Flow rate (l/min)	Connecting thread	Connection for pressure gauge	Dimensions (WxDxH)
FRL PR-1/4" f	2813920000	700	G 1/4"i	G 1/8"i	42x42x94
FRL PR-1/4" f NPT	2813920033	700	G 1/4"i	G 1/8"i	42x42x94
FRL PR-3/8" f	2813920001	2,500	G 3/8"i	G 1/8"i	60x60x130
FRL PR-3/8" f NPT	2813920034	2,500	G 3/8"i	G 1/8"i	60x60x130
FRL PR-1/2" f	2813920002	2,500	G 1/2"i	G 1/8"i	60x60x130
FRL PR-1/2" f NPT	2813920035	2,500	G 1/2"i	G 1/8"i	60x60x130
FRL PR-3/4" f	2813920003	5,600	G 3/4"i	G 1/4"i	80x80x184
FRL PR-3/4" f NPT	2813920004	5,600	G 3/4"i	G 1/4"i	80x80x184
FRL PR-1" f	2813920005	5,600	G 1"i	G 1/4"i	80x80x184
FRL PR-1" f NPT	2813920006	5,600	G 1"i	G 1/4"i	80x80x184



Water separator with filter

- ▶ Two-stage mechanical filter with 20 µm
- ▶ Semi-automatic drainage
- ▶ Centrifugal acceleration of compressed air for efficient separation of dirt particles and condensate
- ▶ Filtering function upstream of the pressure reducer

MODEL	Part number	Connecting thread	Condensate tank volume (cm ³)	Dimensions (WxDxH)
FRL WS-1/4" f	2813920007	G 1/4"i	10	42x42x156
FRL WS-1/4" f NPT	2813920036	G 1/4"i	10	42x42x156
FRL WS-3/8" f	2813920008	G 3/8"i	45	60x60x195
FRL WS-3/8" f NPT	2813920037	G 3/8"i	45	60x60x195
FRL WS-1/2" f	2813920009	G 1/2"i	45	60x60x195
FRL WS-1/2" f NPT	2813920038	G 1/2"i	45	60x60x195
FRL WS-3/4" f	2813920010	G 3/4"i	170	80x80x260
FRL WS-3/4" f NPT	2813920011	G 3/4"i	170	80x80x260
FRL WS-1" f	2813920012	G 1"i	170	80x80x260
FRL WS-1" f NPT	2813920013	G 1"i	170	80x80x260



Filter pressure reducer

- ▶ With lockable adjustment button
- ▶ Regulation range 0-12 bar
- ▶ Standard features include: pressure gauge and 20 µm filter element
- ▶ Combines the technical benefits of the pressure reducer and the water separator with filter in one compact unit
- ▶ Pressure regulator with piston for high operational reliability
- ▶ Assembly independent of flow direction thanks to double-sided connection option for pressure gauge

MODEL	Part number	Flow rate (l/min)	Connection thread	Condensate tank volume (cm ³)	Dimensions (WxDxH)
FRL FPR-1/4"f	2813920014	700	G 1/4"i	10	42x42x190
FRL FPR-1/4"f NPT	2813920039	700	G 1/4"i	10	42x42x190
FRL FPR-3/8"f	2813920015	2,500	G 3/8"i	45	60x60x245
FRL FPR-3/8"f NPT	2813920040	2,500	G 3/8"i	45	60x60x245
FRL FPR-1/2"f	2813920016	2,500	G 1/2"i	45	60x60x245
FRL FPR-1/2"f NPT	2813920041	2,500	G 1/2"i	45	60x60x245
FRL FPR-3/4"f	2813920017	5,600	G 3/4"i	170	80x160x332
FRL FPR-3/4"f NPT	2813920018	5,600	G 3/4"i	170	80x160x332
FRL FPR-1"f	2813920019	5,600	G 1"i	170	80x160x332
FRL FPR-1"f NPT	2813920020	5,600	G 1"i	170	80x160x332



Mist oiler

- ▶ Regular oil flow for efficient supply to tools
- ▶ Proportional adjustment of the oil supply to the air flow rate for optimal lubrication possible, even at low pressures and low air flow rates
- ▶ Oil purification downstream of the filter pressure reducer

MODEL	Part number	Connecting thread	Oil reservoir volume (cm ³)	Dimensions (WxDxH)
FRL MO-1/4"f	2813920021	G 1/4"i	50	42x42x156
FRL MO-1/4"f NPT	2813920042	G 1/4"i	50	42x42x156
FRL MO-3/8"f	2813920022	G 3/8"i	150	60x60x195
FRL MO-3/8"f NPT	2813920043	G 3/8"i	150	60x60x195
FRL MO-1/2"f	2813920023	G 1/2"i	150	60x60x195
FRL MO-1/2"f NPT	2813920044	G 1/2"i	150	60x60x195
FRL MO-3/4"f	2813920024	G 3/4"i	379	80x80x260
FRL MO-3/4"f NPT	2813920045	G 3/4"i	379	80x80x260
FRL MO-1"f	2813920025	G 1"i	379	80x80x260
FRL MO-1"f NPT	2813920046	G 1"i	379	80x80x260



Filter units

- ▶ With lockable adjustment button
- ▶ Regulation range 0-12 bar
- ▶ Standard features include: pressure gauge and 20 µm filter element
- ▶ Fully fitted maintenance system consisting of filter pressure reducer and mist oiler (2-way filter unit) or filter water separator, pressure reducer and mist oiler (3-way filter unit) ready for immediate operation
- ▶ Pressure regulator with piston for high operational reliability

(2-way filter unit 1/4", 3/8" and 1/2")				(3-way filter unit 3/4" and 1")	
MODEL	Part number	Flow rate (l/min)	Version	Connecting thread	Dimensions (WxDxH)
FRL FPR-MO-1/4"f	2813920026	700	double	G 1/4"i	84x42x190
FRL FPR-MO-1/4"f NPT	2813920047	700	double	G 1/4"i	84x42x190
FRL FPR-MO-3/8"f	2813920027	2,500	double	G 3/8"i	120x60x245
FRL FPR-MO-3/8"f NPT	2813920048	2,500	double	G 3/8"i	120x60x245
FRL FPR-MO-1/2"f	2813920028	2,500	double	G 1/2"i	120x60x245
FRL FPR-MO-1/2"f NPT	2813920049	2,500	double	G 1/2"i	120x60x245
FRL FPR-MO-3/4"f	2813920029	5,600	double	G 3/4"i	160x80x332
FRL FPR-MO-3/4"f NPT	2813920030	5,600	double	G 3/4"i	160x80x332
FRL FPR-MO-1"f	2813920031	5,600	double	G 1"i	160x80x332
FRL FPR-MO-1"f NPT	2813920032	5,600	double	G 1"i	160x80x332



Service & Aftermarket

Air. Anytime. Anywhere.

ABAC not only your trusted compressed air brand



Services we offer

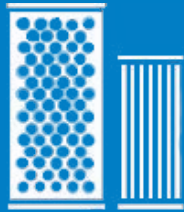

Original Parts



Original Service

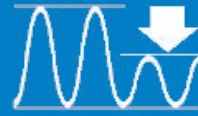

Optimization

Original Parts make the difference

The Original Parts represent the support needed to keep your equipment performing reliably. In addition to quality spare parts, this includes professional service by factory-trained professionals. This is the value of our Original Parts and Service:

Care

Care is what service is all about: professional service by knowledgeable people, using high-quality Original Parts.

Trust

Trust is earned by delivering on our promises of reliable, uninterrupted performance and long equipment lifetime.

Efficiency

Equipment efficiency is ensured by regular maintenance. Efficiency of the service organization is how Original Parts and Service make the difference.



Specifically designed

Original Parts are specifically designed for your compressor



Reliable performance

They ensure the integrity of your system and its reliable performance



Quality control

They are subjected to rigorous quality control by your trusted brand



Overall costs

Taking a risk with generic parts will increase your overall costs



Energy efficiency

Protect your investment with Original Parts and achieve maximum energy efficiency



Service kits

Benefit from the advantages of our complete service kits

The reasons to use ABAC Original Parts

Reduce costs and save energy

Unprofessional maintenance might lead to supplementary unpredictable high cost due to piston failure, wear, break-down cost, reduced lifetime and even to contamination of the compressed air supply.

Respecting service intervals and using ABAC Original Parts **increase the lifetime** of your compressed air installation and cause a minimal average pressure drop, which leads to **energy savings and cost effectiveness**.

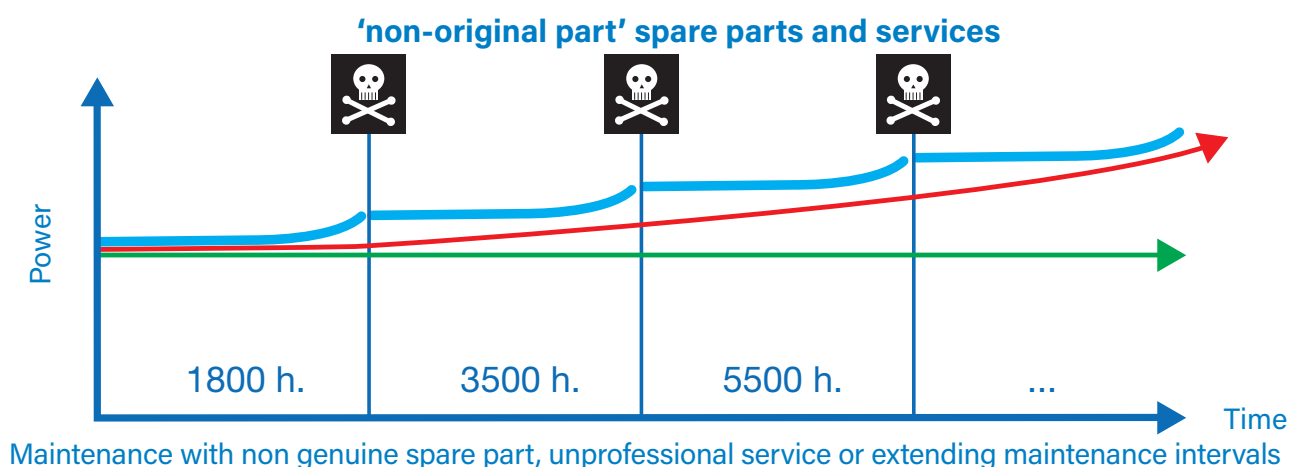
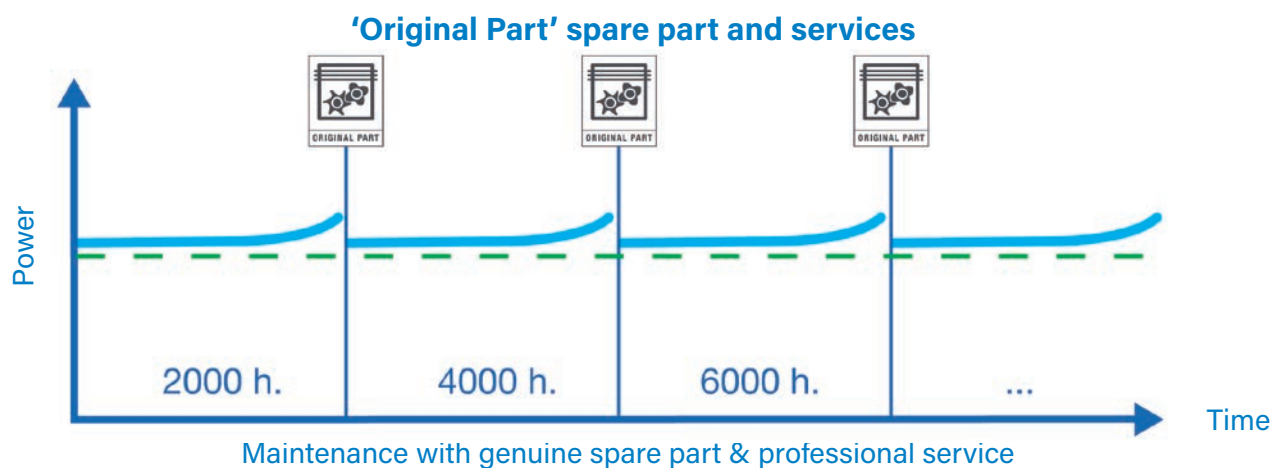

Get maximum performance and efficiency

A breakdown of your compressor would not only be costly but could also result in business reduction and revenue loss. With ABAC Original Parts, you can increase the reliability of your compressor by reducing the risk of a breakdown.

Look for your quality assurance!

Tailored Lubricants

Service and kits

Benefits:

- ▶ Warranty of compressor
- ▶ Maximum performance & efficiency
- ▶ Tested and approved for all applications & environments
- ▶ Extended lifetime of your compressor
- ▶ Firm grip on maintenance cost

Altair chemical properties are specifically engineered to maximize the reliability of every single component of your compressor.

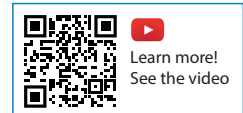

PISTON COMPRESSOR OIL	Description	Q.ty	Part number	Applications
	Altair Ultra	1L	1830065502	ABAC Tech Industrial range
		5L	1830065503	
	ABAC PRO OIL	1 L	2236116963	Light and Hobby applications (<500h / year) Professional applications 1 stage compressors
	Altair	1 L	6215716300	Environmental industry Prolonged use Industry in general 2 stages
	Altair Plus	5 L	6215715800	Totally synthetic, heavy duty applications

The use of low performance lubricants will irreversibly damage your equipment and lead to high maintenance and repair cost.

The use of ABAC engineered lubricants will help you to reduce the risk of:

- ▶ Piston failure
- ▶ Wear of components, increased friction, cavitations
- ▶ Reduced cooling, bearings and components
- ▶ Reduced critical clearance
- ▶ Corrosion
- ▶ Wrong ph damage of parts, seals and internals
- ▶ Damage to the paint layer on the internal parts (coolers, pipes..)
- ▶ Low performance, higher energy consumption
- ▶ Deposits
- ▶ High unpredictable maintenance cost
- ▶ Clogging of air filters
- ▶ Increased oil consumption

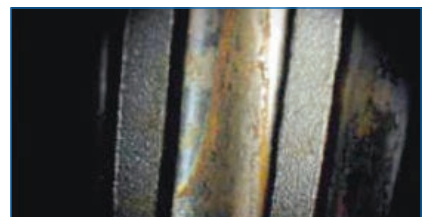
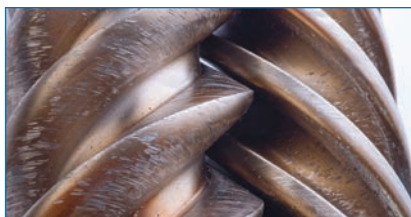
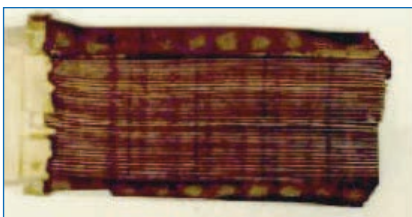

In compressors, oil & air are in close contact. A mist of lubricant is repeatedly exposed to large volumes of hot air, **creating ideal oxidising conditions.**

Oil Oxidation

Causes

- High operating temperature
- High deposit formation
- No additives to disperse or deterge oxidation products and soluble organic acids



Reduced oil lifetime

Effect (sludge)

- Deposit formation
- Oil thickening
- Lacquering
- Colour changes

Anti-oxidant additives delay the oxidising process, deposit and acid formation, to **extend oil lifetime** and protect equipment during stand-still period.

Oil change is due

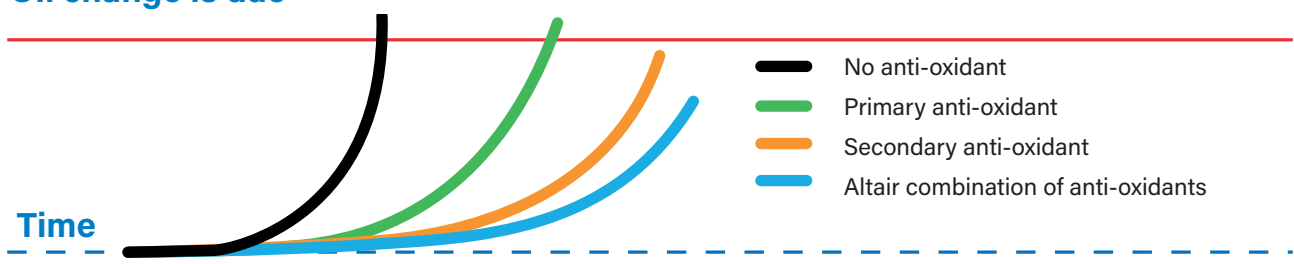

ABAC Tech Spare Parts

Service and kits



Air Filter Kit

RANGE	Model	Description	Part number
ATF-S	ATF-S 3	Kit Air Intake ATF-S 3-4	2901320479
	ATF-S 4	Kit Air Intake ATF-S 3-4	2901320479
ATF	ATF2, ATF3	Filter kit	1503614361
	ATF5.5, ATF7.5, ATF10	Filter kit	1503614362
ATL	ATL2, ATL3	Filter kit	1503614361
	ATL5.5, ATL7.5, ATL10	Filter kit	1503614362
ATH	ATH2, ATH3	Filter kit	1503614361
	ATH5.5, ATH7.5, ATH10	Filter kit	1503614362
	ATH15, ATH20	Filter kit	1503614387

Oil

RANGE	Description	Part number
ATL, ATH	Altair Ultra 1L	1830065502
	Altair Ultra 5L	1830065503

Valve Kit

RANGE	Model	Description	Part number
ATF-S	ATF-S 3	Kit Valve plate ATF-S 3-4	2901320483
	ATF-S 4	Kit Valve plate ATF-S 3-4	2901320483
ATF	ATF2, ATF3	Valve kit	1503614363
	ATF5.5, ATF7.5, ATF10	Valve kit 7HP, 10HP	1503614364
ATL	ATL2, ATL3	Valve kit	1503614363
	ATL5.5, ATL7.5, ATL10	Valve kit 7HP, 10HP	1503614364
ATH	ATH2, ATH3, ATH5.5	Valve kit	1503614388
	ATH7.5, ATH10	Valve kit	1503614389
	ATH15	Valve kit	15036143690
	ATH20	Valve kit	1503614391

Piston Ring Kit

RANGE	Model	Description	Part number
ATF-S	ATF-S 3	Kit Rings Gasket ATF-S 3	2901320474
	ATF-S 4	Kit Rings Gasket ATF-S 4	2901320475
ATF	ATF2, ATF3	Piston Ring Kit 2-3HP	1503614431
	ATF5.5, ATF7.5	Piston Ring Kit 7-10HP	1503614432
	ATF10	Piston Ring Kit 10HP	1503614433
ATL	ATL2, ATL3	Piston Ring Kit	1503614369
	ATL5.5, ATL7.5	Piston Ring Kit	1503614370
	ATL10	Piston Ring Kit	1503614371
ATH	ATH2, ATH3	Piston Ring Kit	1503614408
	ATH5.5	Piston Ring Kit	1503614409
	ATH7.5-15, ATH10	Piston Ring Kit	1503614410
	ATH7.5-20, ATH7.5-30	Piston Ring Kit	1503614411
	ATH15-20, ATH20-20	Piston Ring Kit 20 Bar	1503614412
	ATH15-30, ATH20-30	Piston Ring Kit 30 Bar	1503614413

Pumps

Service and kits

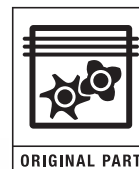

Oilless direct drive compressor pumps

- ▶ Aluminium heads and cylinders with large cooling fins for better cooling.
- ▶ Strip stainless steel valves for higher output.
- ▶ Forced cooling with air conveying for better heat loss.



OSS 20

Lubricated direct drive compressor pumps

- ▶ Low current absorption.
- ▶ Single phase electric motor with overheating thermal protection.
- ▶ Robust, light and compact.
- ▶ Final 100% testing.

MODEL	Part number
PUMP B15/O15	1129704342
PUMP L20	1129100245
PUMP L25P	1129102631
PUMP L30P	1129102621
PUMP OSS 10	1129741076
PUMP OSS 20	1129741077



L20



L25



L30P



V30

Single stage belt driven compressors pumps

- ▶ Aluminium heads with large cooling fins for better cooling.
- ▶ Larger oil sump for better lubrication.
- ▶ Special valve plates with higher load resistance.



A29B BLU



A39B BLU



A29B-0

Service & Aftermarket

Two stage belt driven compressors pumps

- ▶ Powerful, quiet and safe.
- ▶ Suitable for heavy-duty applications.
- ▶ Designed for longer life.
- ▶ Low energy consumption.
- ▶ Two stage pumps with intermediate cooling between compression stages.

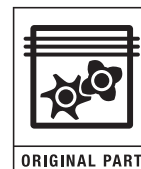

B4900



A49B



B5900B

MODEL	Part number
PUMP V30	1122020717
PUMP A29	4116090644
PUMP A29B	4116090646
PUMP A39	4116090649
PUMP A39B	4116090651
PUMP B26	1129705342
PUMP B26B	1129705343
GR.NS29/B4900 C/RC.FL.VL.	4116090005
GR.NS29S/B4900B CL.FL.VL.	6218739600
GR.B 5900B C/CL.FIL.VOL. (filtro povero)	6218740200
GR.B 5900B C/COLL.SIL.08 (filtro a tazza)	4116090265
PUMP NS 39	6218739900
GR.B 6000 C/COLL.FIL.VOL. (filtro a fungo)	6218740100
GR.B 7000 C/COLL.FIL.VOL.	6218740000
GR.B6000 C/COL.FIL.SIL.04	6218741500
GR.B7000 C/COL.FIL.SIL.04	6218741600
PUMP NS 59/S-B 7900/S	6218740300
PUMP NS 89/B 8900 S/VOLANO	4116090002



B6000



B7000



B7900



BV8900

Piston Spare Parts

Performance kits

Kit components:

- ▶ Head and cylinder plate gaskets.
- ▶ Intercooler and aftercooler gaskets.
- ▶ Valve plate assembly (or internals).
- ▶ Filter element.
- ▶ Non-return valve internals.

Benefits:

- ▶ One single kit
- ▶ Extended lifetime
- ▶ Cost effective
- ▶ Detailed maintenance instructions
- ▶ With and without approved and certified Altair lubricant.
- ▶ Easy and cost efficient inventory management



Performance kit increased lifetime

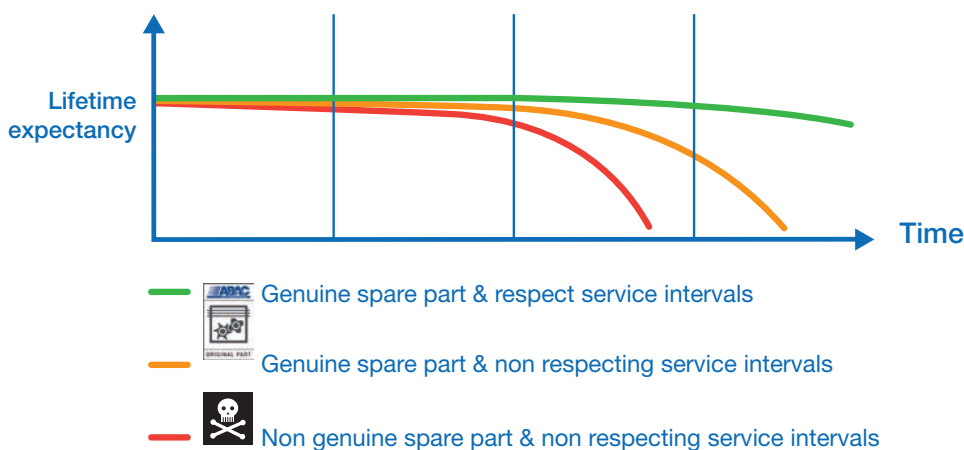

Service Kit

How to identify the type of Performance Kit you need:

- 1) Look at the first 3 characters at the label of your compressor
- 2) Find the appropriate type of the performance kit in the table below



PUMP	Description	Part number
Service kit OSS10/OSS20	Service kit	1129708084
Service kit A29/A29-0/A39/A39-0	Service kit	8973037657
Service kit B3900 & B4000	Service kit	8973037622
Service kit B49	Service kit	8973037624
Service kit A49B	Service kit	8973037939
Service kit B50	Service kit	8973037626
Service kit B59	Service kit	8973037628
Service kit B59 NEW	Service kit	8973037630
Service kit B60	Service kit	8973037632
Service kit B60 NEW	Service kit	8973037634
Service kit B60 SILENT	Service kit	8973037646
Service kit B70	Service kit	8973037636
Service kit B70 SILENT	Service kit	8973037648
Service kit NS39	Service kit	8973037638
Service kit NS59S	Service kit	8973037640
Service kit NS89	Service kit	8973037644

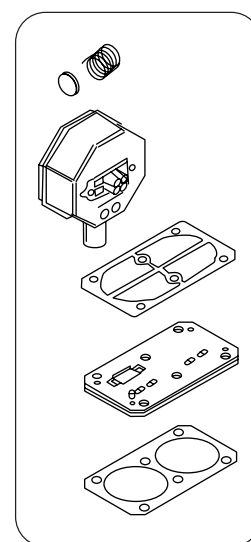

Light Kit

PUMP	Description	Part number
Light kit OSS10/OSS20	Light kit	1129708083
Light kit A29/A29-0/A39/A39-0	Light kit	8973037864
Light kit A49B	Light kit	8973037941
Light kit B4900/NS29	Light kit	8973037867
Light kit NS39	Light kit	8973037875
Light kit B5900B	Light kit	8973037869
Light kit B6000	Light kit	8973037871
Light kit B6000 SILENT	Light kit	8973037881
Light kit B7000/B7900	Light kit	8973037873
Light kit B7000 SILENT	Light kit	8973037883
Light kit BV8900/NS89	Light kit	8973037879

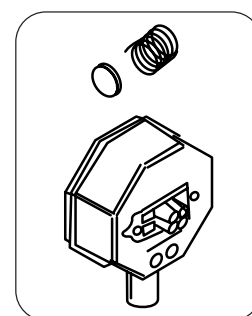

A29(B), A29B-0 and A39(B), A39B-0 Service Kits

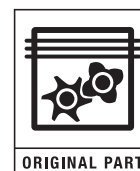

A29(B) Spare Part Kits

PUMP KIT	Description	Part number
305	Air Filter Complete	2236112835
310	Cylinder Head Kit	2901325044
325	Valve Plate Kit	2236112518
330	Upgrade Kit	2901325046
335	Gasket Kit	2901325045
340	Aftercooler Kit	2236112794
345	Cylinder Gasket Screw Kit	2236112434
350	Flywheel Kit	2901325048
355	Piston Conrod Kit single stage	2236111619
360	Oil Level Kit	2901325049
365	Crankcase Kit	2236112437
KM1	Maintenance Kit	8973037864
PK1	Performance Kit	8973037657

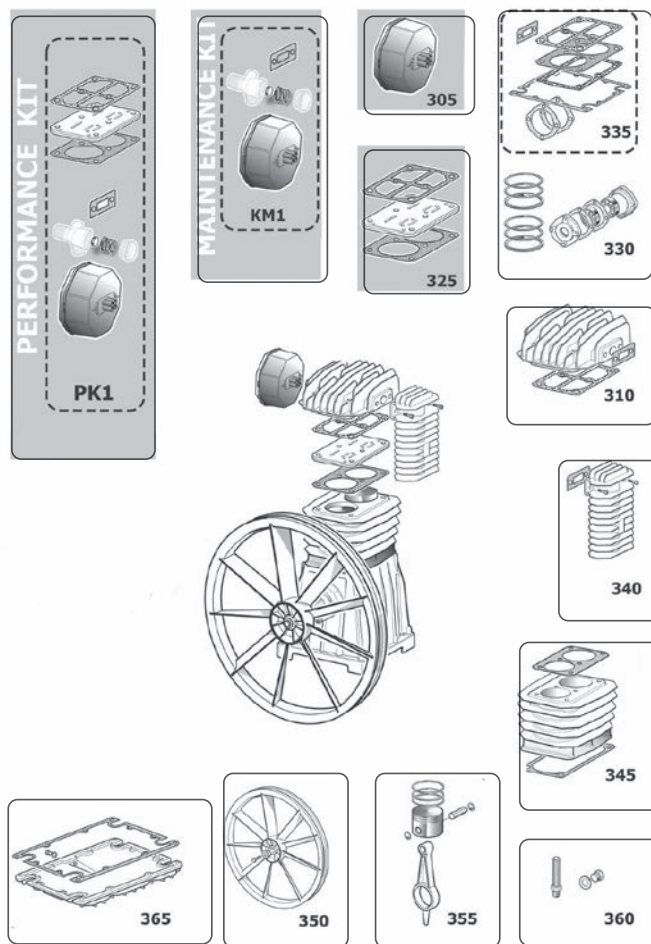

A39(B) Spare Part Kits

PUMP KIT	Description	Part number
305	Air Filter Complete	2236112835
310	Cylinder Head Kit	2901325044
325	Valve Plate Kit	2236112518
330	Upgrade Kit	2901325046
335	Gasket Kit	2901325045
340	Aftercooler Kit	2236112794
345	Cylinder Gasket Screw Kit	2236112435
350	Flywheel Kit	2901325050
355	Piston Conrod Kit single stage	2236111620
360	Oil Level Kit	2901325049
365	Crankcase Kit	2236112438
KM1	Maintenance Kit	8973037864
PK1	Performance Kit	8973037657

A29B-0 Spare Part Kits

PUMP KIT	Description	Part number
305	Air Filter	2236112735
330	Upgrade Kit	1129706833
335	Kit Joint	2901325045
KM1	Kit Performance Light	8973037864
PK1	Kit Performance	8973037657
HDK	Heavy Duty Kit	8973037952

A39B-0 Spare Part Kits

PUMP KIT	Description	Part number
305	Air Filter	2236112735
330	Upgrade Kit	1129706833
335	Kit Joint	2901325045
KM1	Kit Performance Light	8973037864
PK1	Kit Performance	8973037657
HDK	Heavy Duty Kit	8973037953

A49B Service Kit

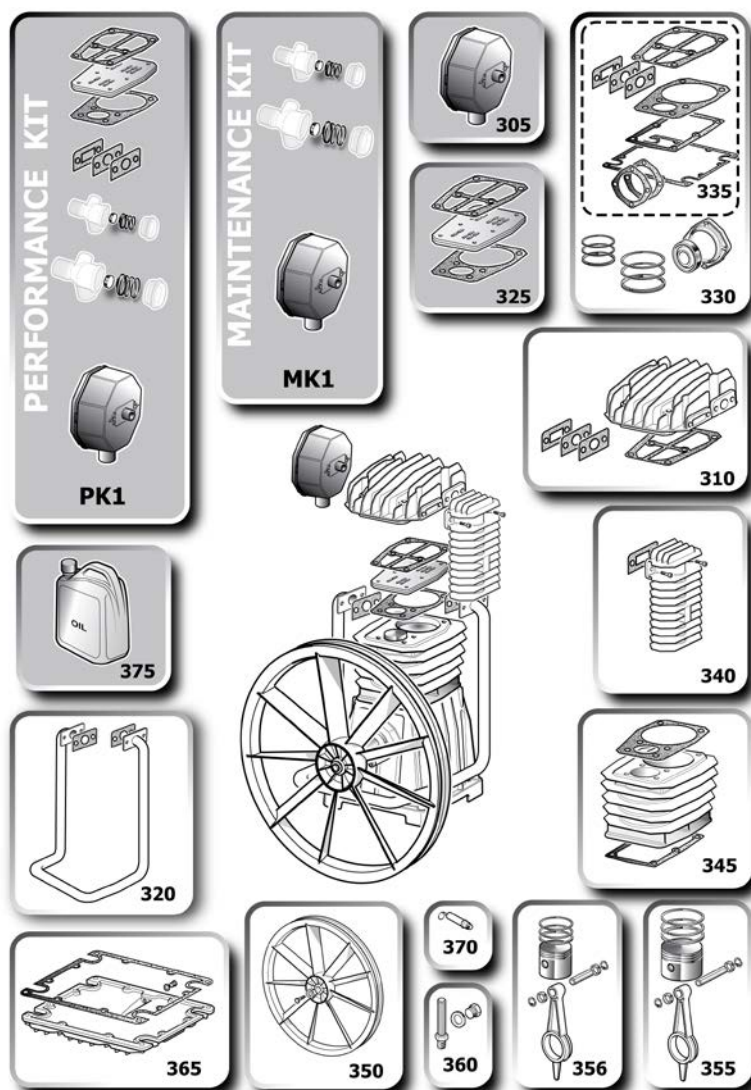
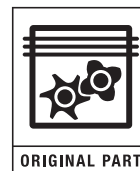

A49(B) Spare Part Kits

PUMP KIT	Description	Part number
305	Air Filter	2236113754
310	Cylinder Head Kit	2901320419
320	Cooler kit	2901320421
325	Valve Plate Kit	2236113917
330	Upgrade Kit	2901320420
335	Gasket Kit	8973037937
340	Aftercooler Kit	2236112794
345	Cylinder Kit	2236113914
350	Flywheel Kit	2901325050
355	Conrod-piston kit LP	1129704957
356	Conrod-piston kit HP	1129704958
360	Oil level kit	2901325049
365	Crankcase cover kit	2236112438
370	Safety valve kit	1127190235
KM1	Service kit light	8973037941
PK1	Performance kit	8973037939

B4900, B5900 Service Kits

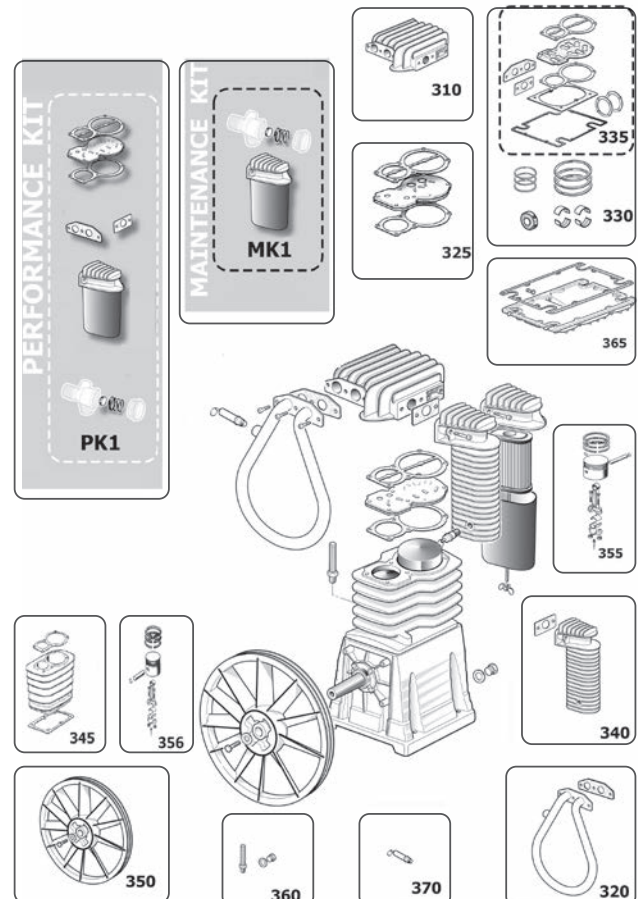
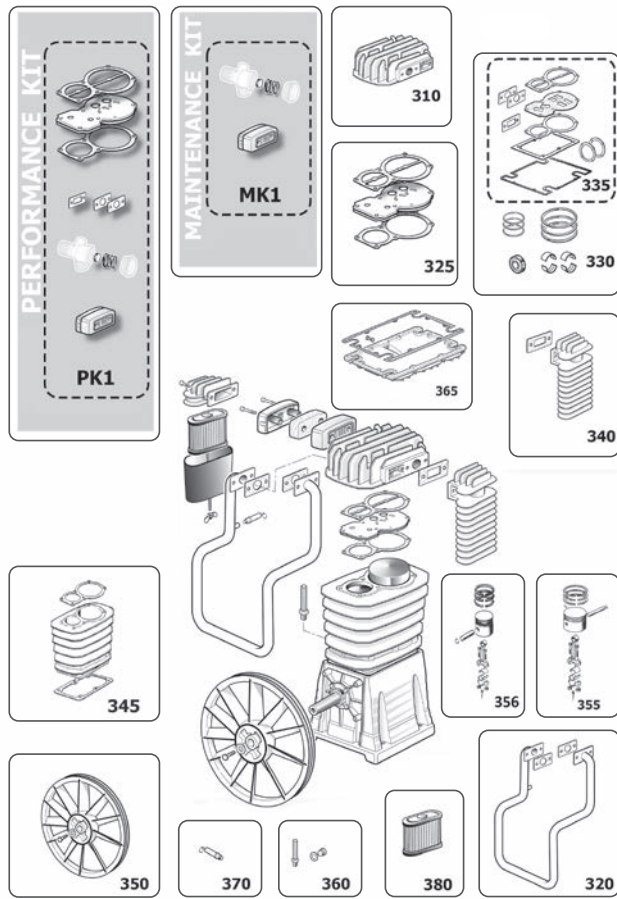

B4900 Spare Part Kits

PUMP KIT	Description	Part number
310	Cylinder Head Kit	2901324960
320	Intercooler Kit	2901324961
325	Valve Plate Kit	2236112796
330	Upgrade Kit	6229017300
335	Gasket Kit	8973035118
340	Aftercooler Kit	2901324962
345	Cylinder Gasket Screw Kit	2236112800
350	Flywheel Kit	6229017600
355	Piston Conrod Kit LP	2236112798
356	Piston Conrod Kit HP	2236112797
360	Oil Level Kit	2901324950
365	Crankcase Kit	2236112799
370	Valve Kit	6210716600
380	Filter Cartridge	8973035059
MK1	Maintenance Kit	8973037867
PK1	Performance Kit	8973037624

B5900 Spare Part Kits

PUMP KIT	Description	B59 - 6218740200
310	Cylinder Head Kit	2901324964
320	Intercooler Kit	2901324965
325	Valve Plate Kit	2236112801
330	Upgrade Kit	6229026900
335	Gasket Kit	8973037264
340	Aftercooler Kit	2901324966
345	Cylinder Gasket screw Kit	2236112805
350	Flywheel Kit	6229028500
355	Piston Conrod Kit LP	2236112803
356	Piston Conrod Kit HP	2236112802
360	Oil Level Kit	2901324952
365	Crankcase Kit	2236112804
370	Valve Kit	6229020200
MK1	Maintenance Kit	8973037869
PK1	Performance Kit	8973037628
345	Cylinder Gasket Screw Kit	2236112800
350	Flywheel Kit	6229017600

B7000 and B6000 Service Kits

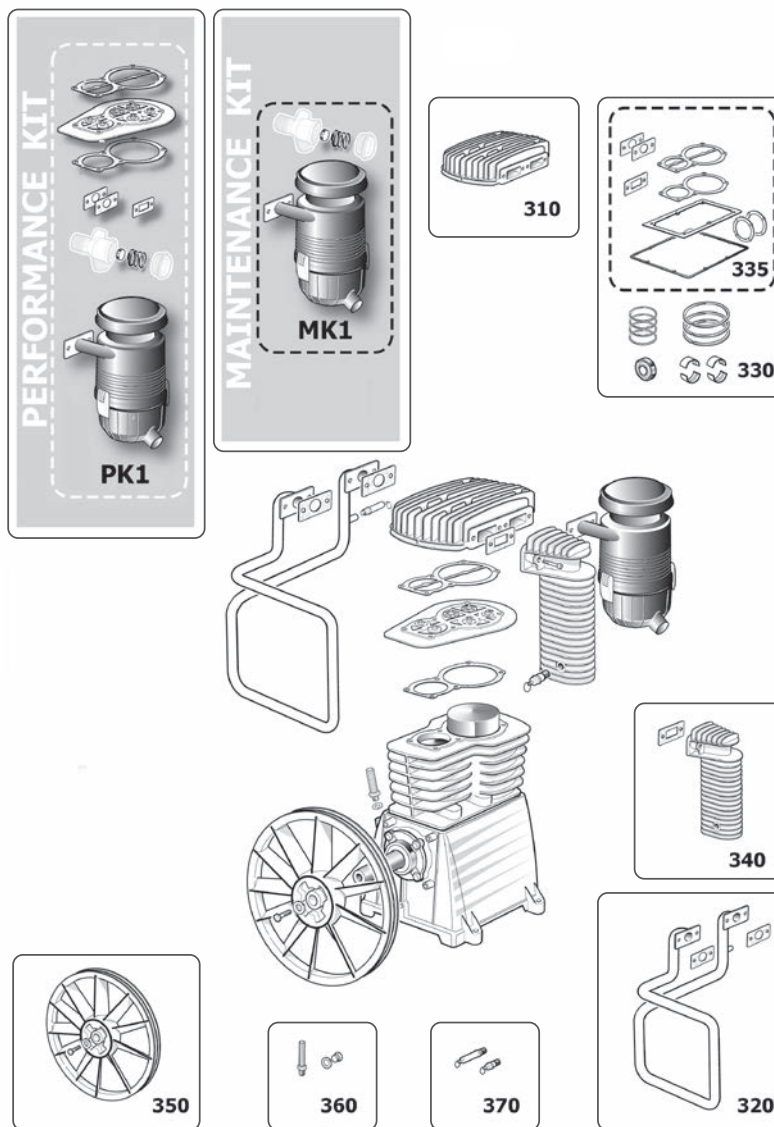
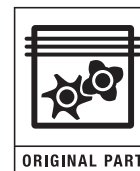

B6000 Spare Part Kits

PUMP KIT	Description	B60 - 6218740100
310	Cylinder Head Kit	2901324967
320	Intercooler Kit	2901324968
330	Upgrade Kit	6229027600
335	Gasket Kit	8973035123
340	Aftercooler Kit	2901324966
350	Flywheel Kit	6229028500
360	Oil Level Kit	2901324952
370	Valve Kit	6229020200
MK1	Maintenance Kit	8973037871
PK1	Performance Kit	8973037632

B7000 Spare Part Kits

PUMP KIT	Description	B70 - 6218740000
310	Cylinder Head Kit	2901324969
320	Intercooler Kit	2901324970
330	Upgrade Kit	6229028200
335	Gasket Kit	8973035130
340	Aftercooler Kit	2901324966
350	Flywheel Kit	6229028500
360	Oil Level Kit	2901324953
370	Valve Kit	6229020200
MK1	Maintenance Kit	8973037873
PK1	Performance Kit	8973037636

Air Intake Filters

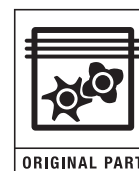

PART NUMBER	Part number light KIT	Description	Complete filter	Cartridge air filter
-	-	Air filter kit O10P / V30	2234900038	-
-	-	Air filter kit O20P	2234900042	-
-	-	Air filter kit L25P / L30P	1124080140	-
-	-	Filter G3 / 8	1129703717	-
6229020700	-	Air filter kit L20 / FC2	-	-
-	-	Air filter B26 / B26B / L20	1124080137	-
8973037821	-	Air filter kit O20P / OM231	-	-
2901323013	-	Filter unit B2 / 3/4900 (cup)	-	8973035059
2236102105	-	Filter B 2/3/4000	-	-
6211471600	-	Filter B 5900/6000 (rectangular)	-	8973035122
-	8973037620	Filter kit B2800 / B3800	6229020500	-
-	8973037864	Air filter kit A29/A29-0/A39/A39-0	2236112835	-
2236113754	-	Air filter A49B	-	-
-	8973037867	Filter B 4900 / NS29 (rectangular)	6211471500	8973035119
-	-	NS39 filter	6211471900	-
-	8973037875	Oil Bath Filter Unit 6000 / NS39 (cup with filter support)	2901323130	8973035036
-	-	Filter B 5900 (cup)	6211475800	-
-	8973037869	Filter unit B5900 (cup with filter support)	2236102168	6211452400
-	8973037871	Air filter B6000 ASS. 2011	2236110427	-
-	8973037873	Air filter B7000 / B7900 ASS. 2011	2236110428	8973015500
-	8973037881	Filter B 6000 SILENT 04	6211475900	8973037390
-	8973037883	Filter B 7000 SILENT 0	6211475901	8973037390
-	8973037879	Filter BV8900 / NS89	6211471900	-

Valve Plates

PART NUMBER	Part number performance KIT	Description
1129700177	-	Valve Plates kit B15/O15
1124080116	-	Valve Plates kit B20
1124080123	-	Valve Plates kit L20/L25P/L30P
2236108137	-	Valve Plates kit D240 - D3
2236108136	-	Valve Plates kit D260 - D4
2236109961	-	Valve Plates kit F1 310
6229025100	-	Valve Plates kit FC2
2236112518	-	Valve Plates kit PAT24 - A29 / PAT38 - A39
-	1124080112	Valve Plates kit V30
-	1124080150	Valve Plates kit B26/B26B
2236113917	-	Valve Plate Kit 49B
-	8973037624	Valve Plates kit B4900
-	8973037628	Valve Plates kit B5900B
-	8973037632	Valve Plates kit B6000
-	8973037636	Valve Plates kit B7000
-	8973037638	Valve Plates kit NS39
-	8973037640	Valve Plates kit B7900 - NS59S
-	8973037644	Valve Plates kit BV8900 - NS89



Upgrade Kit

PART NUMBER	Model
2901324933	Upgrade Kit 2800
2901324900	Upgrade Kit 3800
2901325045	Upgrade Kit A29/NS12 - A39/NS19
1129706833	Upgrade kit A29B-0/A39B-0
2901320420	Upgrade Kit A49B
6229017300	Upgrade Kit B4900/NS29S
6229026900	Upgrade Kit B5900B
6229027600	Upgrade Kit B6000
6229018500	Upgrade Kit NS39
6229028200	Upgrade Kit B7000
6229019800	Upgrade Kit B7900/NS59
2901324956	Upgrade Kit BV8900/NS89

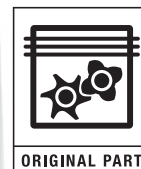
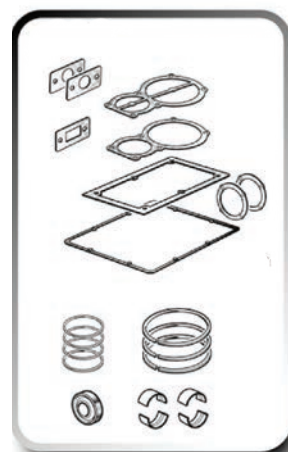

Oil Level Kit

PART NUMBER	Model
6229021000	Oil Level Kit 2800/3800 - NS11/NS18
1127180012	Oil Sight Glass 3/8 - B26/B26B
2901324950	Oil Level Kit B4900/NS29S
2901325049	Oil Level Kit A29/A39/A49B
2901324954	Oil Level Kit NS39
2901324952	Oil Level Kit B6000/B5900B
2901324953	Oil Level Kit KIT 7000
2901324955	Oil Level Kit B7900/NS59
2901324959	Oil Level Kit BV8900/NS89

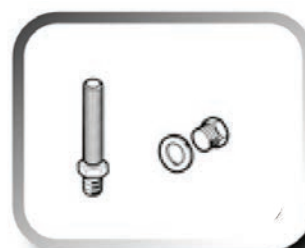

Gasket Kits

PART NUMBER	Model
1124080122	Gasket Kits B20
1124080138	Gasket Kits L20
1124080147	Gasket Kits V30
1124080208	Gasket Kits B26/B26B
1124080191	Gasket Kits L25P/L30P
2236108150	Gasket Kits paper F1 260 - D4
2236108151	Gasket Kits paper F1 310
2236108152	Gasket Kits paper F1 D3
6229023600	Gasket Kits paper B2800/B2800I/B3800
2901325045	Gasket kits A29/A29B-0/A39/A39B-0
6229023700	Gasket Kits paper F1/OM 241
6229023800	Gasket Kits paper FC 2
8973035112	Complete gasket set B4000
8973035118	Complete gasket set B4900 / NS29S
8973037937	Gasket kits A49B
8973035123	Gasket Kits B6000
8973035130	Complete gasket set B7000
8973037264	Complete gasket set B5900 / 5900B NEW
8973037265	Complete gasket set NS 59 / S

Belt for piston air compressors



PUMP	Power HP	Flywheel diameter mm	Diameter pulley mm	RPM	Belt	Part number	Q.ty
B 2800	2	280	90	938	Belt A50	6214629600	1
B 2800	2	280	110	1147	Belt A51	6214629700	1
B26	2	300	140	1400	Belt A46	1127370006	1
B 2800B	2	280	90	938	Belt A50	6214629600	1
B 2800B	3	280	120	1251	Belt A52	6214630100	1
B 2800B	3	280	160	1668	Belt A53	0367102100	1
B 2800B	3	280	160	1668	Belt A53	0367102100	1
B26B	3	300	160	1600	Belt A47	1127370105	1
B 2800I	2	280	140	1459	Belt A52	6214630100	1
B 2800I	2	280	150	1564	Belt A53	0367102100	1
B 3800	3	350	130	1084	Belt A56	6214631600	1
B 3800	4	350	160	1334	Belt A58	0367108100	1
A29	2	323	90	1075	Belt A53	0367102100	
A29B	2	323	90	1075	Belt A53	0367102100	
A29B	2	323	110	1075	Belt A55	6214631100	
A29B	3	323	130	1300	Belt A59	6214632100	
A29B	3	323	160	1300	Belt A57	2236100519	
A39/A39B	3	383	130	1050	Belt A59	6214632100	
A39B	3	383	130	1050	Belt A59	6214632100	
A39B	4	383	150	1300	Belt A59	6214632100	
A49B							
A49B							
A49B							
A49B							
B 4900	4	350	160	1303	Belt A59	6214632100	
B 5900	5,5	430	180	1193	Belt A72	0367103000	2
B 6000	5,5	430	140	928	Belt A70	6214634300	2
B 6000	7,5	430	200	1326	Belt A72	0367103000	2
B 7000	7,5	430	140	928	Belt A70	6214634300	2
B 7000	10	430	200	1326	Belt A72	0367103000	2
B 8900	20	630	200	905	Belt SPA	2236100525	2

TO CHECK
BASED
ON MACHINE

Pressure Switches

Pressure Switches

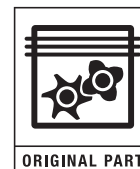

TYPE	Part number	Description	Compressor
Direct Driven	8973036418	Kit Strumenti 24-50L RC	Pole Position e Montecarlo RC
	1129701904	Pressure Switches 8 BAR	B15/B20
	1129702262	Pressure Switches 8 BAR MINI	O15
	8973037679	Pressure Switches	Start, Pole Position e Montecatrllo O15
	1127250074	Pressure Switches 8 BAR	O20P, O10P, L30PO20P, O10P, L30P
	8973035964	Pressure Switches 4V 1/4 C/VALV SC.	Start O20P/L20
	1129700388	Pressure Switches 10 BAR	L20/L25PL30P
	8973037572	Pressure Switches 4V 3/8 C/VALV.TIPO 2	Pole Position e Montecarlo L20
	8973037699	Pressure Switches	Pole Position, Montecarlo O20P-L20P-L30P e ESTORIL L30P
Belt 1 Stage	6256396900	Pressure Switches 3/8	2 hp (also silenced versions)
	2236106647	Pressure Switches 3/8+ MDR1	3 hp single phase (also GV34 and silenced versions)
	1127250036	PR.CONDOR MDR2/11	3 hp single phase
	1127250024	Pressure Switches NEMA 4 WAY	3 hp single phase
	1127250074	Pressure Switches 8BAR	3 hp single phase
	2236112288	Pressure Switches 4V 3/8+MDR3/11-R3/6 3 10B	3 hp three-phase (also silent versions 2 - 3 hp)
Belt 2 Stage	2236112290	Pressure Switches 4V 3/8+MDR3/11-R3/10 10B	4/5.5 hp (also silenced versions)
	2236112292	Pressure Switches 4V 3/8+MDR3/11-R3/16 10B	7,5 hp
	2236100438	Pressure Switches 1/4 MDR3/11-R3/20	10 hp
	1089038953	MDR4S/11 G 1/2	15/20 hp and Tandem
	2236100425	Pressure Switches 4VIE 3/8MDR2/11 INT.8B	5,5/7,5/10 hp with star-delta start
	2236100427	Pressure Switches 1/4+ MDR4S/11	7,5/10 hp silenced (also versions with star-delta starting)
	2236100426	Pressure Switches 1/4+ MDR4S/16	7,5/10 hp 15 bar
	2236111839	Kit Control BOX-PAN.SIL R3/10	Silenced products before 2011 with pressure switch code 6256397400
	2236111841	Kit Control BOX-PAN.SIL.R3/16	Silenced products before 2011 with pressure switch code 2236100457
2236111843	Kit Control BOX-PAN.SIL.R3/20	Silenced products before 2011 with pressure switch code 6256396300	



Spare parts for screw compressors



The use of low performance lubricants will irreversibly damage your equipment and lead to high maintenance and repair cost.



The use of ABAC engineered lubricants will help you to reduce the risk of:

- ▶ Compression element failure
- ▶ Wear of components, increased friction, cavitations
- ▶ Reduced cooling, overheating bearings, compression elements, components
- ▶ Reduced critical clearance
- ▶ Corrosion
- ▶ Wrong ph damage of parts, seals and internals
- ▶ Varnish layer on internal parts (coolers, piping,...)
- ▶ Low performance, higher energy consumption
- ▶ Deposits
- ▶ High unpredictable maintenance cost
- ▶ Clogging of oil filter, separator and down stream air filters
- ▶ Limited operation range.

In compressors, oil & air are in close contact. A mist of lubricant is repeatedly exposed to large volumes of hot air, **ideal oxidising conditions**.

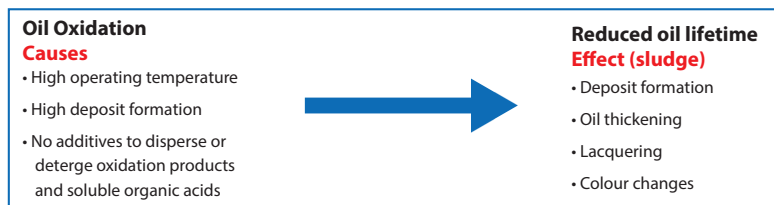

Anti-oxidant additives delay the oxidising process, deposit and acid formation to extend oil lifetime and protect equipment during stand-still period.

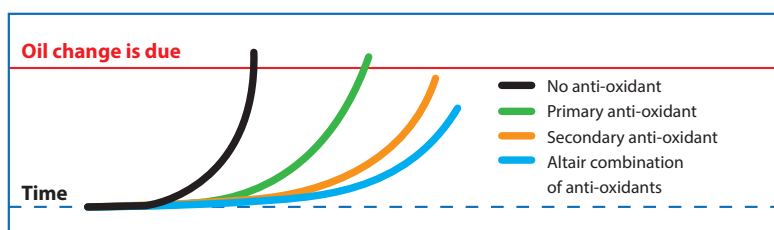



Screw Compressor Oil	Description	Q.ty	Part number	Hours
	FluidTech	5L	6215715900	2000h
		20 L	6215716000	
		209 L	6215716100	
FluidTech Advanced	5 L	1630021082	2000h	
	20 L	1630021085		
	209 L	1630021088		
Rotair Plus	5 L	1630144405	4000h	
	20 L	1630144402		
	209 L	1630144429		
Rotair Food Grade	5 L	1630082100	4000h	
	20 L	1630060500		
	209 L	1630008201		
Rotair Extra	5 L	6215714800	8000h	
	20 L	6215714900		
	209 L	6215715000		

'Original Part' spare part and services

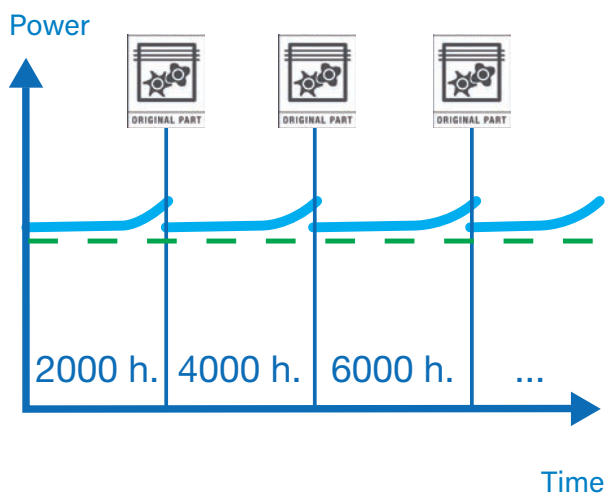

Maintenance with genuine spare part & professional service

'non-original part' spare part and services

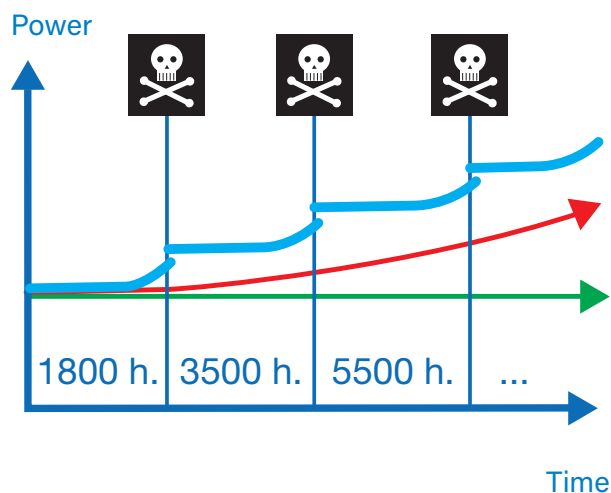

Maintenance with non genuine spare part, unprofessional service or extending maintenance intervals

SPINN 2.2 - 5.5 (C40) Since November 2009

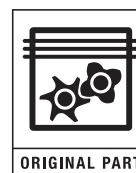

MODEL	Serial number	Description	Part number	Various
Spinn 2.2 - 5.5	From > CAI377158	Service kit A/F - O/F	2200902300	-
		Service kit A	2200902301	Af-of-Sep-
	From > ITJ011xxx	Service kit B	2200902394	MPV+ASP.+THERM
Lubricated	FluidTech			2.5 litres

SPINN 5.5 - 11 (C55) Since May 2010

MODEL	Serial number	Description	Part number	Various
Spinn 5.5 - 7.5 - 11 C55	From > CAI430575 From > ITJ011XXX	Air Filter	6211473950	-
		Oil Filter	6211472550	-
		Separator	6221372850	-
		Pre-filter *	2202715000	-
		Intake Valve Kit	2200900961	-
		MPV + Thermo Kit	2901109500	-
Lubricated	FluidTech			3 litres
CONTENUTO KIT				
Spinn 5.5 - 7.5 - 11	-	Service Kit A/F - O/F	2200902356	A/F - O/F
	-	Service Kit "A"	2200902354	A/F - O/F - SEP
	-	Service Kit "B"	2200902395	MPV+ASP.+THERM
	-	Service Kit "C"	2200902355	KIT A+B

FORMULA - GENESIS 5.5 - 15 (C55DD - C67) Since March 2010

MODEL	Serial number	Description	Part number	Various
Formula E - Genesis 5.5 - 7.5 - 11kW C55DD	From > ITJ131XXX	Service Kit "A"	2200903266	A/F - O/F + Filter dryer
			2200903283	A/F - O/F - Without dryer
		Service Kit "B"	2200903267	A/F - O/F + SEP. + Filter dryer
			2200902593	A/F - O/F - SEP. Without dryer
		Service Kit "C"	2200903281	With dryer
		Kit "B" + Kit Asp. + MPV Therm + Check Valve	2200903270	Without dryer
Formula E 15 kW Genesis 15* C67	From > ITJ131XXX	Service Kit "A"	2200903268	A/F - O/F + Filter dryer
			2200903284	A/F - O/F + Without dryer
		Service Kit "B"	2200903269	A/F - O/F - SEP. + Filter dryer
			2200902595	A/F - O/F - SEP. + Without dryer
		Service Kit "C"	2200903282	With dryer
		Kit "B" + Kit Asp. + MPV Therm + Check Valve	2200903271	Without dryer
Lubricated	FluidTech			5 litres

FORMULA - GENESIS 18,5 - 22KW (C67) Since March 2019

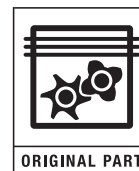

From serial numbers ITJ131XXX

MODEL	Description	Part number	Various
FORMULA 18,5kW C/DRYER From serial number ITJ131XXX	Service Kit "A"	2200903272	Air filters / Oil filters / Dryer filters
	Service Kit "B"	2200903273	KIT "A" + SEP. + Air prefilters and Inverter panel
	Service Kit "C"	2200903277	KIT "B" + KIT VALVE ASP. + CHECK VALVE + KIT MPV / THERM. + WEAR DRAIN
FORMULA 18,5kW S/DRYER From serial number ITJ131XXX	Service Kit "A"	6229030400	Air / Oil Filters
	Service Kit "B"	2200903275	KIT "A" + SEP. + Air prefilters and Inverter panel
	Service Kit "C"	2200903279	KIT "B" + KIT VALVE ASP. + CHECK VALVE + KIT MPV / THERM. + WEAR DRAIN FORMULA 22 kW C / DRYER
FORMULA 22kW C/DRYER From serial number ITJ131XXX	Service Kit "A"	2200903272	Air / Oil filters
	Service Kit "B"	2200903274	KIT "A" + SEP. + Air prefilters and Inverter panel
	Service Kit "C"	2200903278	KIT "B" + KIT VALVE ASP. + CHECK VALVE + KIT MPV / THERM. + WEAR DRAIN
FORMULA 22kW S/DRYER From serial number ITJ131XXX	Service Kit "A"	6229030400	Air / Oil filters
	Service Kit "B"	2200903276	KIT "A" + SEP. + Air prefilters and Inverter panel
	Service Kit "C"	2200903280	KIT "B" + KIT VALVE ASP. + CHECK VALVE + KIT MPV / THERM. + WEAR DRAIN

FORMULA - GENESIS 18,5 - 22kW (C67)

Since March 2018

From serial numbers ITJ131XXX

BELTS MACHINES FIXED SPEED

HP / KW	Bar/psi	50 Hz	
		Part number	Q.ty
25 / 18,5	8	6214622300	3
	10	2200660517	3
	13	2200660517	3
30 / 22	8	2200660517	3
	10	6214626500	3
	13	2200660527	3

BELTS MACHINES VARIABLE SPEED

HP / KW	Bar/psi	50 Hz VSD	
		Part number	Q.ty
25 / 18,5	8	-	3
	10	2200660523	3
	13	2200660527	3
30 / 22	8	-	3
	10	6214616400	3
	13	6214616400	3

FORMULA 30KW (C80)

MODEL	Serial number	Description	Part number	Various
FORMULA 30 kW	From CAI426098 to CAI999999 From ITJ000000 to ITJ076933	Service Kit "A"	6229030400	Air / Oil filters
		Service Kit "B"	2200902714	KIT "A" + SEP. Air prefilters
FORMULA 30 kW	From ITJ076934	Service Kit "A"	6229030400	Air / Oil filters
		Service Kit "B"	2200902714	KIT "A" + SEP. + Air prefilters

FORMULA 30 - 75 Fixed speed

Since 2017

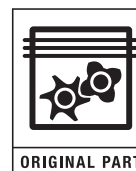

MODEL	Serial number	Description	Part number	NOTE
FORMULA 30	TRD	Service Kit A 2000h	2205722766	Air and oil filters
		Service Kit B 4000h	2205722767	Air / Oil / Oil separator filters
		Fluidtech conf. 20 IT.	6215716000	Content 10Lt
FORMULA 37	TRD	Service Kit A 2000h	2205722766	Air and oil filters
		Service Kit B 4000h	2205722767	Air / Oil / Oil separator filters
		Fluidtech conf. 20 IT.	6215716000	Content 10Lt
FORMULA 38	TRD	Service Kit A 2000h	2205722766	Air and oil filters
		Service Kit B 4000h	2205722882	Air / Oil / Oil separator filters
		Fluidtech conf. 20 IT.	6215716000	Content 10Lt
FORMULA 45	TRD	Service Kit A 2000h	2205722772	Air and oil filters
		Service Kit B 4000h	2205722773	Air / Oil / Oil separator filters
		Fluidtech conf. 20 IT.	6215716000	Content 20Lt
FORMULA 55	TRD	Service Kit A 2000h 55kW	2205722885	Air and oil filters
		Service Kit B 4000h 55kW	2205722586	Air / Oil / Oil separator filters
		Fluidtech conf. 20 IT.	6215716000	Content 20Lt
FORMULA 75	TRD	Service Kit A 2000h	2205722889	Air and oil filters
		Service Kit B 4000h	2903752501	Air / Oil / Oil separator filters
		Fluidtech conf. 20 IT.	6215716000	Content 36Lt

FORMULA 30 - 75 Variable speed

Since 2017

MODEL	Serial number	Description	Part number	NOTE
FORMULA 37 IVR	TRD	Service Kit A 2000h	2205722766	Air and oil filters
		Service Kit B 4000h	2205722767	Air / Oil / Oil separator filters
		Fluidtech conf. 20 IT.	6215716000	Content 10Lt
FORMULA 45 IVR	TRD	Service Kit A 2000h	2205722772	Air and oil filters
		Service Kit B 4000h	2205722773	Air / Oil / Oil separator filters
		Fluidtech conf. 20 IT.	6215716000	Content 10Lt
FORMULA 55 IVR	TRD	Service Kit A 2000h 55kW IVR	2205722885	Air and oil filters
		Service Kit B 4000h 55kW IVR	2205722886	Air / Oil / Oil separator filters
		Fluidtech conf. 20 IT.	6215716000	Content 10Lt
FORMULA 75 IVR	TRD	Service Kit A 2000h IVR	2205722889	Air and oil filters
		Service Kit B 4000h IVR	2205722890	Air / Oil / Oil separator filters
		Fluidtech conf. 20 IT.	6215716000	Content 20Lt

FILTER ELEMENTS



Part number	Line Filter Elements
2258293501	Filter Element for FP - 1
2258293502	Filter Element for FP - 2
2258293503	Filter Element for FP - 3
2258293504	Filter Element for FP - 4
2258293505	Filter Element for FP - 5
2258293506	Filter Element for FP - 6
2258293507	Filter Element for FP - 7
2258293508	Filter Element for FP - 8
2258293509	Filter Element for FP - 9
2258293510	Filter Element for FP - 10
2258293511	Filter Element for FP - 11
2258293512	Filter Element for FP - 12
2258293513	Filter Element for FP - 13
2258293514	Filter Element for FP - 14
2258293515	Filter Element for FP - 15
2258293516	Filter Element for FP - 16
2258293517	Filter Element for FP - 17
2258293518	Filter Element for FP - 18
2258293601	Filter Element for FG / FS - 1
2258293602	Filter Element for FG / FS - 2
2258293603	Filter Element for FG / FS - 3
2258293604	Filter Element for FG / FS - 4
2258293605	Filter Element for FG / FS - 5
2258293606	Filter Element for FG / FS - 6
2258293607	Filter Element for FG / FS - 7
2258293608	Filter Element for FG / FS - 8
2258293609	Filter Element for FG / FS - 9
2258293610	Filter Element for FG / FS - 10
2258293611	Filter Element for FG / FS - 11
2258293612	Filter Element for FG / FS - 12
2258293613	Filter Element for FG / FS - 13
2258293614	Filter Element for FG / FS - 14
2258293615	Filter Element for FG / FS - 15
2258293616	Filter Element for FG / FS - 16
2258293617	Filter Element for FG / FS - 17
2258293618	Filter Element for FG / FS - 18

Part number	Line Filter Elements
2258293701	Filter Element for FC / FD - 1
2258293702	Filter Element for FC / FD - 2
2258293703	Filter Element for FC / FD - 3
2258293704	Filter Element for FC / FD - 4
2258293705	Filter Element for FC / FD - 5
2258293706	Filter Element for FC / FD - 6
2258293707	Filter Element for FC / FD - 7
2258293708	Filter Element for FC / FD - 8
2258293709	Filter Element for FC / FD - 9
2258293710	Filter Element for FC / FD - 10
2258293711	Filter Element for FC / FD - 11
2258293712	Filter Element for FC / FD - 12
2258293713	Filter Element for FC / FD - 13
2258293714	Filter Element for FC / FD - 14
2258293715	Filter Element for FC / FD - 15
2258293716	Filter Element for FC / FD - 16
2258293717	Filter Element for FC / FD - 17
2258293718	Filter Element for FC / FD - 18
2258293801	Filter Element for FV - 1
2258293802	Filter Element for FV - 2
2258293803	Filter Element for FV - 3
2258293804	Filter Element for FV - 4
2258293805	Filter Element for FV - 5
2258293806	Filter Element for FV - 6
2258293807	Filter Element for FV - 7
2258293808	Filter Element for FV - 8
2258293809	Filter Element for FV - 9
2258293810	Filter Element for FV - 10
2258293811	Filter Element for FV - 11
2258293812	Filter Element for FV - 12
2258293813	Filter Element for FV - 13
2258293814	Filter Element for FV - 14
2258293815	Filter Element for FV - 15
2258293816	Filter Element for FV - 16
2258293817	Filter Element for FV - 17
2258293818	Filter Element for FV - 18



Ease and affordable access to compressor status information

Get access to valuable equipment status information

Thanks to the ICONS clamp, monitoring capabilities are now available for compressors up to 30kW.

By showing you the service status of your equipment, ICONS makes on-time service easier.

Connecting the ICONS Clamp to your installation will provide you full visibility, whatever the equipment type or brand.

It's simply the best way to ensure the reliable performance of your compressed air installation.

How does it work?

Once attached, the ICONS clamp gets its power from the machine. No wires or batteries needed!

By detecting the compressor's power consumption, the clamp registers its running hours and load/unload status.

These can be consulted on the user-friendly ICONS platform.



3 simple steps

STEP 1

Click the ICONS Clamp around one of the input phases of your compressor.

STEP 2

Scan the QR code with your smartphone or tablet and register.

STEP 3

Open the ICONS platform and start monitoring your equipment.

<https://portal.connectivityicons.com>

AirTube



Get the most from your piston compressor

Let our app guide you through the critical operations needed for your piston compressor. Would you like to keep your piston compressor running on best shape?

Would you like to be informed and trained on how to perform maintenance and keep track on warranty? Would you like to be informed about future developments and offers?

AirTube has been developed to be your personal assistant when it comes to:

- ▶ E-Service: Hands-on video tutorial about set-up and maintenance
- ▶ Applications: Explore everything you can do with your compressor
- ▶ Documentation: User manuals and technical documents always at hand
- ▶ Troubleshooting and buy online: Find our authorized partners ready to assist you in diagnose and in the purchase process



AIR TUBE

ABAC Air Compressors SRL
Via Cristoforo Colombo, 3 - 10070 Robassomero (TO) Italy
TEL. +39 011 9246415-421
WWW.ABACAIRCOMPRESSORS.COM

©ABAC 2024
THE CONTENTS OF THIS PUBLICATION ARE THE COPYRIGHT OF THE PUBLISHER AND MAY NOT BE REPRODUCED (EVEN EXTRACTS)
UNLESS PRIOR WRITTEN PERMISSION IS GRANTED. EVERY CARE HAS BEEN TAKEN TO ENSURE THE ACCURACY OF THE INFORMATION
CONTAINED IN THIS PUBLICATION BUT NO LIABILITY CAN BE ACCEPTED FOR ANY LOSS OR DAMAGE WHETHER DIRECT, INDIRECT OR
CONSEQUENTIAL ARISING OUT OF THE USE OF THE INFORMATION CONTAINED HEREIN.

CERTAIN IMAGE(S) USED UNDER LICENSE FROM SHUTTERSTOCK.COM.

